

2019

SEATING
TABLES
LIGHTING
COMPLEMENTS

PRICELIST
DESIGN SOLUTIONS

PRICELIST DESIGN SOLUTIONS

PEDRALI
THE ITALIAN ESSENCE

2019

Pedrali SpA
Sp 122 Mornico Al Serio
24050 Bergamo - Italy
Export Dept. Tel: +39 035 8358840
Ufficio Commerciale Italia Tel: +39 035 8358810

info@pedrali.it www.pedrali.it

L_DEST1910

PEDRALI[®]
THE ITALIAN ESSENCE

PEDRALI[®]
THE ITALIAN ESSENCE

Seating, tables, complements and lighting index

Indice sedute, tavoli, complementi e lampade

SEATING / SEDUTE

| | | | |
|----------------|-----|-------------|-----|
| Allure | 011 | Ice | 063 |
| Ara | 012 | Ikon bench | 065 |
| Arki-Stool | 013 | Inga | 068 |
| Arod | 013 | Intrigo | 073 |
| Babila | 015 | Island | 074 |
| Babila Comfort | 026 | Jamaica | 075 |
| Blitz | 027 | Jazz | 076 |
| Box | 028 | Jil | 077 |
| Brera | 029 | Joi | 079 |
| Buddy | 033 | Joker | 079 |
| Buddy Sofa | 031 | Koi-Booki | 079 |
| Cube | 037 | Kuadra | 080 |
| Day Dream | 038 | Kuadra XL | 086 |
| Dome | 039 | Laja | 090 |
| Dress | 041 | Leila | 093 |
| Elinor | 042 | Log | 093 |
| Enjoy | 042 | Malmö | 095 |
| Ester | 043 | Mies | 101 |
| Feel | 045 | Modus | 102 |
| Folk | 046 | Modus 2.0 | 109 |
| Fox | 049 | Mood | 114 |
| Frida | 051 | Mya | 114 |
| Gliss | 051 | Nemea | 115 |
| Gossip | 060 | Noa | 116 |
| Grace | 060 | Nolita | 119 |
| Happy | 060 | Nym | 123 |
| Héra | 061 | Osaka | 133 |
| Host | 061 | Osaka Metal | 134 |
| Host lounge | 063 | Pasha | 138 |

SEATING / SEDUTE

| | |
|-------------|-----------|
| Plural | 140 |
| Plus | 146 |
| Plus Air | 146 |
| Queen | 148 |
| Remind | 148 |
| Reva | 150 |
| Rubik | 151 |
| Sign | 152 |
| Smart | 152 |
| Snow | 152 |
| Snow junior | 153 |
| Social | 154 |
| Social Plus | 158 |
| Soul | 161 |
| Sunset | 161 |
| Tatami | 164 |
| Temps | 165 |
| Tivoli | 165 |
| Trend | 167 |
| Tribeca | 167 |
| Tweet | 169 |
| Twig | 177 |
| Vic | 178 - 179 |
| Vic Metal | 178 - 179 |
| Volt | 182 |
| Volt HB | 186 |
| Woody | 187 |
| Wow | 188 |
| Young | 193 |

SEATING / SEDUTE

| | |
|------------|-----|
| Zippo | 194 |
| Miniatures | 196 |

TABLES / TAVOLI

| | |
|------------|-----|
| Aero | 198 |
| Arki-Base | 199 |
| Arki-Table | 201 |
| Babila | 211 |
| Buddy | 212 |
| Code | 214 |
| Elinor | 216 |
| Elliot | 217 |
| Exteso | 219 |
| Fabbrico | 219 |
| Fluxo | 220 |
| Ikon | 222 |
| Inox | 224 |
| Jump | 230 |
| Krystal | 231 |
| Kuadro | 232 |
| Laja | 235 |
| Logico | 238 |
| Lunar | 239 |
| Magic | 240 |
| Malmö | 241 |
| Matrix | 244 |
| More | 247 |

TABLES / TAVOLI

| | |
|------------------------|-----|
| Nolita | 248 |
| Parenthesis | 249 |
| Plano | 251 |
| Side Table | 253 |
| Snow | 254 |
| Snow junior | 254 |
| Space | 257 |
| Stylus | 255 |
| Surface | 257 |
| Togo | 258 |
| Ypsilon | 259 |
| Ypsilon Tilting | 260 |
| Ypsilon 4 | 259 |

**COMPLEMENTS AND LIGHTING /
COMPLEMENTI E LAMPADE**

| | |
|-----------------------------|-----|
| Boxie | 262 |
| Brik | 266 |
| Colette - Colette 50 | 281 |
| Flag | 263 |
| Giravolta | 282 |
| Happy Apple | 283 |
| Iceberg | 269 |
| Igloo | 270 |
| Kado | 267 |
| L001 | 285 |
| L002 | 295 |
| L004 | 298 |
| Oblique | 274 |
| Ray | 265 |
| Snooze | 268 |
| Tetris | 278 |
| Tamara | 300 |
| Time Out | 301 |
| To.Be | 302 |
| | |
| Finishes / Finiture | 303 |
| Fabrics / Tessuti | 306 |

Sales conditions

Condizioni generali di vendita

CONDIZIONI DI VENDITA ITALIA

- I prezzi sono espressi in Euro.
I prezzi indicati in grassetto si intendono IVA INCLUSA (22%) e sono da intendersi come riferimento di prezzi al pubblico.
- L'importo minimo d'ordine è € 200,00 netti IVA esclusa.
Devono essere rispettati i quantitativi minimi d'imballo previsti per ogni modello, come indicato, e si intendono per stessa finitura e colore.
Eventuali imballi singoli accettati eccezionalmente prevedono l'addebito di un supplemento pari a € 8,00 (IVA inclusa).
- La resa della merce è PORTO FRANCO (Italia), salvo diverse indicazioni scritte in conferma d'ordine.
Per ordini di importo inferiore a € 500,00 netti IVA esclusa, saranno addebitati in fattura € 50,00 netti quale parziale contributo per le spese di trasporto sostenute.
- I tempi di consegna sono indicativi e si intendono esclusi dei tempi previsti per il trasporto.
Eventuali ritardi non possono dar luogo a pretese di danni o annullamenti dell'ordine.
- La merce venduta con pagamento dilazionato è rilasciata con condizioni di riserva di proprietà fino a completo pagamento.
- Per ogni controversia è competente il foro di Bergamo, Italia (applicazione legge italiana).
- Eventuali reclami devono essere comunicati entro 8 giorni dal ricevimento della merce. Eventuali resi di merce dovranno essere preventivamente concordati ed autorizzati da Pedrali per iscritto.
- Pesi, dimensioni e colori sono indicativi. Pedrali si riserva la facoltà di apportare modifiche o migliorie senza alcun preavviso.

EXPORT SALE CONDITIONS

- All prices are expressed in Euro.
Export prices are those indicated under the column "VAT NOT INCLUDED".
Prices written in bold are meant valid for the Italian market only (22% VAT included).
- All mentioned prices are on Ex-Works basis.
- Goods travel at customer's own risk.
- Minimum order amount € 200,00 net (VAT excluded).
As clearly stated, minimum packaging quantities are foreseen per each model and are meant per finishing and colour.
Single packaging exceptionally accepted with a surcharge of € 6,50 (VAT not included).
- Delivery time is approximate, unless differently agreed.
Possible delays cannot justify any order cancellation or claim for damages.
- The goods sold through an extended payment are released under the condition with property reserve until full settlement.
- For any dispute the place of jurisdiction will be the Court of Bergamo, Italy (under Italian law).
- Any complaints shall be reported to PEDRALI within 8 days from receipt of the goods. In case of replacement for finished products or components, the freight costs are intended to be EX-WORKS, unless otherwise agreed between the parties.
- Weight, size and colours are approximate. Pedrali reserves the right to modify or upgrade the product without prior notice.
- Upcharge for plastic pallet (according to FAO ISPM15 regulation): € 40,00 each, public price.
- Fixed costs whenever palletized cartons are required for air-freight shipments = € 200,00 net (VAT excluded) per order

Legend

Legenda

| | |
|------------|--|
| FR | Bleached ash / Frassino sbiancato |
| RS | Bleached oak / Rovere sbiancato |
| W | Oak/beechn stained wenge / Rovere/faggio tinto wengé |
| N1 | Oak/ash/beechn stained light walnut / Rovere/frassino/faggio tinto noce chiaro |
| MP | Maple / Acero |
| N | Walnut / Noce |
| AN | Black lacquered oak/ash with visible grains, beech stained black Rovere/frassino laccato nero a poro aperto, faggio tinto nero |
| BI | White lacquered oak/ash with visible grains / Rovere/frassino laccato bianco a poro aperto |
| GC | Light grey lacquered oak/ash with visible grains / Rovere/frassino laccato grigio chiaro a poro aperto |
| NY | Nylon / Nylon |
| PET | Polyethylene / Polietilene |
| PPL | Polypropylene / Polipropilene |
| PC | Polycarbonate / Policarbonato |
| SCR | Chromed ABS / ABS cromato |
| TP | Tecnopolymer / Tecnopolimero |
| ME | Methacrylate / Metacrilato |
| A | Padded with cat. A / Imbottitura con cat. A |
| B | Padded with cat. B / Imbottitura con cat. B |
| C | Padded with cat. C / Imbottitura con cat. C |
| D | Padded with cat. D / Imbottitura con cat. D |
| E | Padded with cat. E / Imbottitura con cat. E |
| F | Padded with genuine or regenerated leather / Rivestimento in cuoio naturale o rigenerato |
| G | Padded with cat. G / Imbottitura con cat. G |
| H | Padded with cat. H / Imbottitura con cat. H |
| N | Padded with cat. N / Imbottitura con cat. N |
| P | Padded with cat. P / Imbottitura con cat. P |
| TXT | Textilene / Textilene |

Legend

Legenda

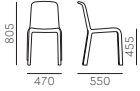

All dimensions are expressed in millimeters
Tutte le dimensioni sono espresse in millimetri



Quantity of pieces each box and volume of the carton in cubic meters
Numero di pezzi contenuti nell'imballo e volume in metri cubi del cartone



Quantity of pieces per pallet
Numero di pezzi contenuti su pallet



Stackable product
Prodotto impilabile



Weight of a single product in kgs
Peso del singolo prodotto espresso in chilogrammi



Product suitable for outdoor use
Prodotto adatto per utilizzo in esterni



Product not recommended for outdoor use
Prodotto non adatto per utilizzo in esterni



Product with swivel seat
Prodotto con seduta girevole



Swivel seat with automatic return mechanism
Prodotto con seduta girevole e meccanismo di ritorno automatico



Catas certification:
Seat and back static load test EN 1728
Seat and back fatigue test, 200.000 cycles EN 1728
Foot rest durability test, 100.000 cycles EN 1728
Combined arm fatigue test, 100.000 cycles EN 1728 - EN 16139

Articolo certificato dall'ente Catas:
Carico statico sul sedile e schienale EN 1728
Resistenza a fatica del sedile-schienale, 200.000 cicli EN 1728
Resistenza a fatica appoggiatesta, 100.000 cicli EN 1728
Resistenza a fatica dei braccioli, 100.000 cicli EN 1728 - EN 16139



FSC™ certified article
Articolo certificato FSC™



PRODUCT CERTIFIED
FOR LOW CHEMICAL
EMISSIONS:
UL COM/IGG
UL 2818

GREENGUARD certified article
Articolo certificato GREENGUARD

Allure 735



| SEAT Sedile | BACK Schienale | FRAME Telaio | OAK Rovere | VAT NOT INCLUDED Iva esclusa 22% |
|----------------|-------------------|-----------------|-----------------|--|
| H | H | RS-W | € 573,00 | € 469,30 |

For fabrics see page 306
Per i tessuti si veda a p. 306

FINISHES / Finiture



PACKING / Imballo



TECHNICAL DETAILS / Dettagli tecnici

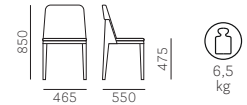

CATAS

Allure 737



| SEAT Sedile | BACK Schienale | FRAME Telaio | OAK Rovere | VAT NOT INCLUDED Iva esclusa 22% |
|----------------|-------------------|-----------------|------------------------------|--|
| H | H | Ø 16 | SATINIZED Satinato | € 706,00 |
| | | | | € 578,50 |

For fabrics see page 306
Per i tessuti si veda a p. 306

FINISHES / Finiture



PACKING / Imballo



TECHNICAL DETAILS / Dettagli tecnici

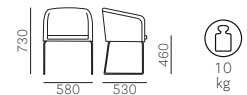

CATAS

Allure 738



| SEAT Sedile | BACK Schienale | FRAME Telaio | OAK Rovere | VAT NOT INCLUDED Iva esclusa 22% |
|----------------|-------------------|-----------------|------------------------------|--|
| H | H | Ø 16 | SATINIZED Satinato | € 674,50 |
| | | | | € 552,50 |

For fabrics see page 306
Per i tessuti si veda a p. 306

FINISHES / Finiture



PACKING / Imballo



TECHNICAL DETAILS / Dettagli tecnici

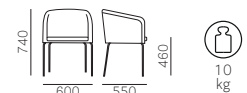

CATAS

Ara 310



| SEAT Sedile | BACK Schienale | FRAME Telaio | POLYPROPYLENE Polipropilene | VAT NOT INCLUDED Iva esclusa 22% |
|----------------|-------------------|-----------------|--------------------------------|--|
| PPL | PPL | PPL | € 94,00 | € 76,70 |

PPL FINISHES / Finiture PPL

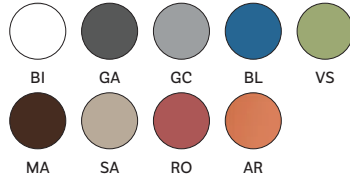

PACKING / Imballo



TECHNICAL DETAILS / Dettagli tecnici



PRODUCT CERTIFIED FOR LOW CHEMICAL EMISSIONS: UL.COM/CGG UL 2818

Ara 315



| SEAT Sedile | BACK Schienale | FRAME Telaio | POLYPROPYLENE Polipropilene | VAT NOT INCLUDED Iva esclusa 22% |
|----------------|-------------------|-----------------|--------------------------------|--|
| PPL | PPL | PPL | € 121,00 | € 98,80 |

PPL FINISHES / Finiture PPL

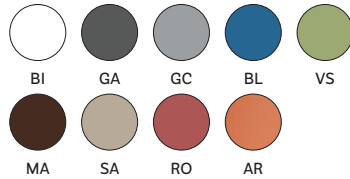

PACKING / Imballo



TECHNICAL DETAILS / Dettagli tecnici

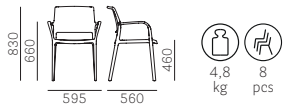

PRODUCT CERTIFIED FOR LOW CHEMICAL EMISSIONS: UL.COM/CGG UL 2818

Ara 316

LOUNGE



| SEAT Sedile | BACK Schienale | FRAME Telaio | POLYPROPYLENE Polipropilene | VAT NOT INCLUDED Iva esclusa 22% |
|----------------|-------------------|-----------------|--------------------------------|--|
| PPL | PPL | PPL | € 151,00 | € 123,50 |

PPL FINISHES / Finiture PPL



PACKING / Imballo



TECHNICAL DETAILS / Dettagli tecnici

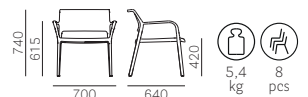

PRODUCT CERTIFIED FOR LOW CHEMICAL EMISSIONS: UL.COM/CGG UL 2818

Ara 310.3

Cushion only
Solo cuscino



| SEAT Sedile | FABRIC Tessuto | VAT NOT INCLUDED Iva esclusa 22% |
|----------------|-------------------|--|
| GC-NE | € 60,50 | € 49,40 |

FINISHES / Finiture

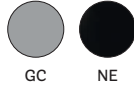

PACKING / Imballo



TECHNICAL DETAILS / Dettagli tecnici

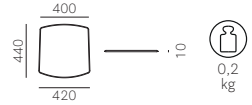

Arki-Stool ARKW6

Gas lift device
Alzata a gas



| SEAT Sedile | FRAME Telaio | WHITE POWDER COATED Verniciato bianco | BLACK POWDER COATED Verniciato nero | TRANSPARENT POWDER COATED Verniciato trasparente | VAT NOT INCLUDED Iva esclusa 22% |
|----------------|-----------------|---|---|--|--|
| RS | 650*755 | € 381,00 | | € 381,00 | € 312,00 |
| AN | | | € 381,00 | | |

FINISHES / Finiture



POWDER COATED FINISHES / Finiture verniciato

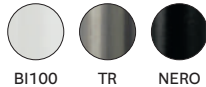

PACKING / Imballo



TECHNICAL DETAILS / Dettagli tecnici



CATAS



Arod 500



| SEAT Sedile | FRAME Telaio | WHITE/BLACK POWDER COATED Verniciato bianco/nero | CHROMED Cromato | VAT NOT INCLUDED Iva esclusa 22% |
|----------------|-----------------|--|--------------------|--|
| PC | 15x15 H650 | € 254,00* | € 254,00 | € 208,00 |
| SCR | | € 325,50 | | € 266,50 |

*Powder coated in the same colour of the shell
Verniciato in tinta con la scocca

PC FINISHES / Finiture PC

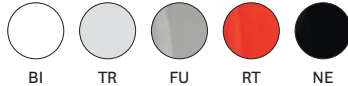

SCR FINISH / Finitura SCR



PACKING / Imballo



TECHNICAL DETAILS / Dettagli tecnici

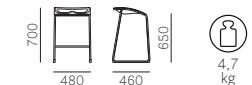

Arod 510



| SEAT Sedile | FRAME Telaio | WHITE/BLACK POWDER COATED Verniciato bianco/nero | CHROMED Cromato | VAT NOT INCLUDED Iva esclusa 22% |
|----------------|-----------------|--|--------------------|--|
| PC | 15x15 H760 | € 270,00* | € 270,00 | € 221,00 |
| SCR | | € 341,00 | | € 279,50 |

*Powder coated in the same colour of the shell
Verniciato in tinta con la scocca

PC FINISHES / Finiture PC

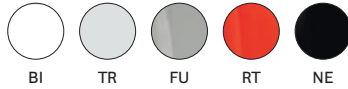

SCR FINISH / Finitura SCR



SCR

PACKING / Imballo



TECHNICAL DETAILS / Dettagli tecnici



Arod 560



| SEAT Sedile | FRAME Telaio | CHROMED Cromato | VAT NOT INCLUDED Iva esclusa 22% |
|----------------|-----------------|--------------------|--|
| PC | 400x400 H770 | € 389,00 | € 318,50 |
| SCR | | € 460,00 | € 377,00 |

PC FINISHES / Finiture PC

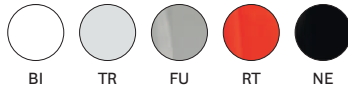

SCR FINISH / Finitura SCR



SCR

PACKING / Imballo



TECHNICAL DETAILS / Dettagli tecnici

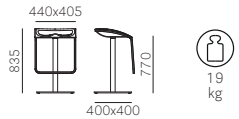

Arod 570

Gas lift device
Alzata a gas



| SEAT Sedile | FRAME Telaio | CHROMED Cromato | VAT NOT INCLUDED Iva esclusa 22% |
|----------------|---------------------|--------------------|--|
| PC | 400x400 H540+800 | € 420,50 | € 344,50 |
| SCR | | € 492,00 | € 403,00 |

PC FINISHES / Finiture PC

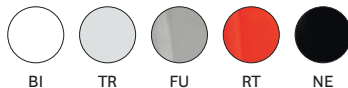

SCR FINISH / Finitura SCR



SCR

PACKING / Imballo



TECHNICAL DETAILS / Dettagli tecnici

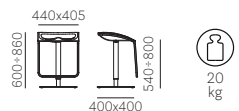

Babila 2730



| SEAT Sedile | BACK Schienale | FRAME Telaio | WHITE/BLACK POWDER COATED Verniciato bianco/nero | CHROMED Cromato | VAT NOT INCLUDED Iva esclusa 22% |
|----------------|-------------------|-----------------|--|--------------------|--|
| BI | BI | Ø 16 | € 105,00 | € 105,00 | € 85,80 |
| | | | € 121,00 | - | € 98,80 |
| SA-GR-GI | SA-GR-GI | | € 113,00 | € 113,00 | € 92,30 |
| | | | € 128,50 | - | € 105,30 |

TP FINISHES / Finiture TP



PACKING / Imballo



TECHNICAL DETAILS / Dettagli tecnici



Babila 2730/A



| SEAT Sedile | BACK Schienale | FRAME Telaio | WHITE POWDER COATED Verniciato bianco | CHROMED Cromato | VAT NOT INCLUDED Iva esclusa 22% |
|----------------|-------------------|-----------------|---|--------------------|--|
| C | BI | Ø 16 | € 167,00 | € 167,00 | € 136,50 |
| D40+D44 | | | € 176,50 | € 176,50 | € 144,30 |
| E | | | € 189,00 | € 189,00 | € 154,70 |
| G | | | € 189,00 | € 189,00 | € 154,70 |
| H | | | € 168,50 | € 168,50 | € 137,80 |
| P | | | € 197,00 | € 197,00 | € 161,20 |

For fabrics see page 306
Per i tessuti si veda a p. 306

TP FINISH / Finitura TP



PACKING / Imballo



TECHNICAL DETAILS / Dettagli tecnici



BS 5852:2006 (Clause 11 Crib 5)

Babila 2740



| SEAT Sedile | BACK Schienale | FRAME Telaio | WHITE/BLACK POWDER COATED Verniciato bianco/nero | CHROMED Cromato | VAT NOT INCLUDED Iva esclusa 22% |
|----------------|-------------------|-----------------|--|--------------------|--|
| BI | BI | Ø 10 | € 113,00 | € 113,00 | € 92,30 |
| SA-GR-GI | SA-GR-GI | | € 121,00 | € 121,00 | € 98,80 |

TP FINISHES / Finiture TP

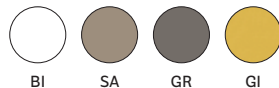

PACKING / Imballo



TECHNICAL DETAILS / Dettagli tecnici



Babila 2740/A



| SEAT Sedile | BACK Schienale | FRAME Telaio | WHITE POWDER COATED Verniciato bianco | CHROMED Cromato | VAT NOT INCLUDED Iva esclusa 22% |
|----------------|-------------------|-----------------|---|--------------------|--|
| C | | | € 174,50 | € 174,50 | € 143,00 |
| D40÷D44 | | | € 184,00 | € 184,00 | € 150,80 |
| E | BI | Ø 10 | € 197,00 | € 197,00 | € 161,20 |
| G | | | € 197,00 | € 197,00 | € 161,20 |
| H | | | € 176,50 | € 176,50 | € 144,30 |
| P | | | € 205,00 | € 205,00 | € 167,70 |

For fabrics see page 306
Per i tessuti si veda a p. 306

TP FINISH / Finitura TP



BI

PACKING / Imballo



TECHNICAL DETAILS / Dettagli tecnici

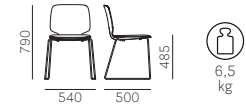

BS 5852:2006 (Clause 11 Crib 5)

Babila 2750



| SEAT Sedile | BACK Schienale | FRAME Telaio | ASH Frassino | VAT NOT INCLUDED Iva esclusa 22% |
|----------------|-------------------|-----------------|-----------------|--|
| BI | BI | FR-N1-AN | € 173,00 | € 141,70 |
| SA-GR-GI | SA-GR-GI | | € 181,00 | € 148,20 |

TP FINISHES / Finiture TP



WOODEN FINISHES / Finiture legno

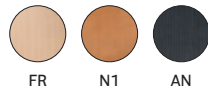

FR

N1

AN

PACKING / Imballo



TECHNICAL DETAILS / Dettagli tecnici



CATAS



Babila 2750/A



| SEAT Sedile | BACK Schienale | FRAME Telaio | ASH Frassino | VAT NOT INCLUDED Iva esclusa 22% |
|----------------|-------------------|-----------------|-----------------|--|
| C | | | € 235,00 | € 192,40 |
| D40÷D44 | | | € 244,50 | € 200,20 |
| E | BI | FR-N1-AN | € 257,00 | € 210,60 |
| G | | | € 257,00 | € 210,60 |
| H | | | € 236,50 | € 193,70 |
| P | | | € 265,00 | € 217,10 |

For fabrics see page 306
Per i tessuti si veda a p. 306

TP FINISH / Finitura TP



BI

WOODEN FINISHES / Finiture legno



FR

N1

AN

PACKING / Imballo



TECHNICAL DETAILS / Dettagli tecnici



CATAS



BS 5852:2006 (Clause 11 Crib 5)

Babila 2700



| SEAT Sedile | BACK Schienale | FRAME Telaio | ASH Frassino | VAT NOT INCLUDED Iva esclusa 22% |
|--------------------|--------------------|--------------------|-----------------|--|
| FR-N1-AN- GC-BI | FR-N1-AN- GC-BI | FR-N1-AN- GC-BI | € 316,00 | € 258,70 |

FINISHES / Finiture



PACKING / Imballo



TECHNICAL DETAILS / Dettagli tecnici



CATAS



Babila 2700/A



| SEAT Sedile | BACK Schienale | FRAME Telaio | ASH Frassino | VAT NOT INCLUDED Iva esclusa 22% |
|----------------|--------------------|--------------------|-----------------|--|
| A | FR-N1-AN- GC-BI | FR-N1-AN- GC-BI | € 374,50 | € 306,80 |
| C | | | € 377,50 | € 309,40 |
| D40÷D44 | | | € 387,00 | € 317,20 |
| E | | | € 400,00 | € 327,60 |
| G | | | € 400,00 | € 327,60 |
| H | | | € 379,50 | € 310,70 |
| P | | | € 408,00 | € 334,10 |

For fabrics see page 306
Per i tessuti si veda a p. 306

FINISHES / Finiture



PACKING / Imballo



TECHNICAL DETAILS / Dettagli tecnici



CATAS

BS 5852:2006 (Clause 11 Crib 5)



Babila 2710



| SEAT Sedile | BACK Schienale | FRAME Telaio | ASH Frassino | | VAT NOT INCLUDED Iva esclusa 22% |
|----------------|-------------------|-----------------|--|--------------------|--|
| | | | WHITE/BLACK POWDER COATED Verniciato bianco/nero | CHROMED Cromato | |
| FR-AN | FR-AN | Ø 16 | € 228,50 | € 228,50 | € 187,20 |

FINISHES / Finiture



PACKING / Imballo



TECHNICAL DETAILS / Dettagli tecnici



Babila 2710/A



| SEAT Sedile | BACK Schienale | FRAME Telaio | ASH Frassino | | VAT NOT INCLUDED Iva esclusa 22% |
|----------------|-------------------|-----------------|--|--------------------|--|
| | | | WHITE/BLACK POWDER COATED Verniciato bianco/nero | CHROMED Cromato | |
| A | FR-AN | Ø 16 | € 287,50 | € 287,50 | € 235,30 |
| C | | | € 290,50 | € 290,50 | € 237,90 |
| D40+D44 | | | € 300,00 | € 300,00 | € 245,70 |
| E | | | € 312,50 | € 312,50 | € 256,10 |
| G | | | € 312,50 | € 312,50 | € 256,10 |
| H | | | € 292,00 | € 292,00 | € 239,20 |
| P | | | € 320,50 | € 320,50 | € 262,60 |

For fabrics see page 306
Per i tessuti si veda a p. 306

FINISHES / Finiture



PACKING / Imballo



TECHNICAL DETAILS / Dettagli tecnici



BS 5852:2006 (Clause 11 Crib 5)



Babila 2720



| SEAT Sedile | BACK Schienale | FRAME Telaio | ASH Frassino | | VAT NOT INCLUDED Iva esclusa 22% |
|----------------|-------------------|-----------------|--|--------------------|--|
| | | | WHITE/BLACK POWDER COATED Verniciato bianco/nero | CHROMED Cromato | |
| FR-AN | FR-AN | Ø 10 | € 220,50 | € 220,50 | € 180,70 |

FINISHES / Finiture



PACKING / Imballo



TECHNICAL DETAILS / Dettagli tecnici

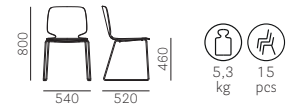

CATAS



Babila 2720/A



| SEAT Sedile | BACK Schienale | FRAME Telaio | ASH Frassino | | VAT NOT INCLUDED Iva esclusa 22% |
|----------------|-------------------|-----------------|--|--------------------|--|
| | | | WHITE/BLACK POWDER COATED Verniciato bianco/nero | CHROMED Cromato | |
| A | FR-AN | Ø 10 | € 279,50 | € 279,50 | € 228,80 |
| C | | | € 282,50 | € 282,50 | € 231,40 |
| D40+D44 | | | € 292,00 | € 292,00 | € 239,20 |
| E | | | € 305,00 | € 305,00 | € 249,60 |
| G | | | € 305,00 | € 305,00 | € 249,60 |
| H | | | € 284,00 | € 284,00 | € 232,70 |
| P | | | € 312,50 | € 312,50 | € 256,10 |

For fabrics see page 306
Per i tessuti si veda a p. 306

FINISHES / Finiture



PACKING / Imballo



TECHNICAL DETAILS / Dettagli tecnici

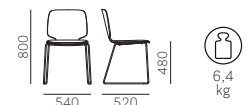

CATAS

BS 5852:2006 (Clause 11 Crib 5)



Babila 2731

SOFT



| SEAT Sedile | BACK Schienale | FRAME Telaio | WHITE/BLACK POWDER COATED Verniciato bianco/nero | CHROMED Cromato | VAT NOT INCLUDED Iva esclusa 22% |
|----------------|-------------------|-----------------|--|--------------------|--|
| C | C | Ø 16 | € 308,00 | € 308,00 | € 252,20 |
| E | E | | € 403,00 | € 403,00 | € 330,20 |
| G | G | | € 403,00 | € 403,00 | € 330,20 |
| H | H | | € 320,50 | € 320,50 | € 262,60 |

For fabrics see page 306
Per i tessuti si veda a p. 306

PACKING / Imballo



TECHNICAL DETAILS / Dettagli tecnici



CATAS

BS 5852:2006 (Clause 11 Crib 5)

Babila 2741

SOFT



| SEAT Sedile | BACK Schienale | FRAME Telaio | WHITE/BLACK POWDER COATED Verniciato bianco/nero | CHROMED Cromato | VAT NOT INCLUDED Iva esclusa 22% |
|----------------|-------------------|-----------------|--|--------------------|--|
| C | C | Ø 10 | € 316,00 | € 316,00 | € 258,70 |
| E | E | | € 411,00 | € 411,00 | € 336,70 |
| G | G | | € 411,00 | € 411,00 | € 336,70 |
| H | H | | € 328,50 | € 328,50 | € 269,10 |

For fabrics see page 306
Per i tessuti si veda a p. 306

PACKING / Imballo



TECHNICAL DETAILS / Dettagli tecnici

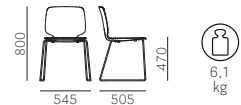

BS 5852:2006 (Clause 11 Crib 5)

Babila 2751

SOFT



| SEAT Sedile | BACK Schienale | FRAME Telaio | ASH Frassino | VAT NOT INCLUDED Iva esclusa 22% |
|----------------|-------------------|--------------------|-----------------|--|
| C | C | FR-N1-AN- GC-BI | € 376,00 | € 308,10 |
| E | E | | € 471,50 | € 386,10 |
| G | G | | € 471,50 | € 386,10 |
| H | H | | € 389,00 | € 318,50 |

For fabrics see page 306
Per i tessuti si veda a p. 306

FINISHES / Finiture



PACKING / Imballo



TECHNICAL DETAILS / Dettagli tecnici



BS 5852:2006 (Clause 11 Crib 5)



Babila 2735



| SEAT Sedile | BACK Schienale | FRAME Telaio | WHITE/BLACK POWDER COATED Verniciato bianco/nero | CHROMED Cromato | VAT NOT INCLUDED Iva esclusa 22% |
|----------------|-------------------|-----------------|--|--------------------|--|
| PPL | PPL | Ø 16 | € 121,00 | € 121,00 | € 98,80 |
| | | | € 136,50 | - | € 111,80 |

PPL FINISHES / Finiture PPL



PACKING / Imballo



TECHNICAL DETAILS / Dettagli tecnici

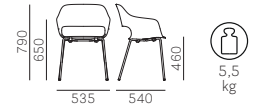

Babila 2745



| SEAT Sedile | BACK Schienale | FRAME Telaio | WHITE/BLACK POWDER COATED Verniciato bianco/nero | CHROMED Cromato | VAT NOT INCLUDED Iva esclusa 22% |
|----------------|-------------------|-----------------|--|--------------------|--|
| PPL | PPL | Ø 11 | € 128,50 | € 128,50 | € 105,30 |

PPL FINISHES / Finiture PPL



PACKING / Imballo



TECHNICAL DETAILS / Dettagli tecnici

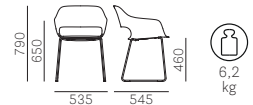

Babila 2755



| SEAT Sedile | BACK Schienale | FRAME Telaio | ASH Frassino | VAT NOT INCLUDED Iva esclusa 22% |
|----------------|-------------------|-----------------|-----------------|--|
| PPL | PPL | FR-N1-AN | € 189,00 | € 154,70 |

PPL FINISHES / Finiture PPL



WOODEN FINISHES / Finiture legno

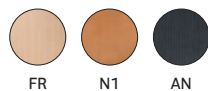

PACKING / Imballo



TECHNICAL DETAILS / Dettagli tecnici

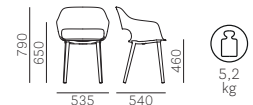

Babila 2775



| SEAT Sedile | BACK Schienale | FRAME Telaio | WHITE/BLACK POWDER COATED Verniciato bianco/nero | POLISHED S/STEEL Inox lucidato | VAT NOT INCLUDED Iva esclusa 22% |
|----------------|-------------------|-----------------|--|-----------------------------------|--|
| PPL | PPL | Ø 680 | € 238,00 | € 285,50 | € 195,00 € 234,00 |

PPL FINISHES / Finiture PPL



PACKING / Imballo



TECHNICAL DETAILS / Dettagli tecnici



Babila 2736

SOFT



| SEAT Sedile | BACK Schienale | FRAME Telaio | WHITE/BLACK POWDER COATED Verniciato bianco/nero | CHROMED Cromato | VAT NOT INCLUDED Iva esclusa 22% |
|----------------|-------------------|-----------------|--|--------------------|--|
| C | C | | € 522,00 | € 522,00 | € 427,70 |
| E | E | Ø 16 | € 734,50 | € 734,50 | € 601,90 |
| G | G | | € 703,00 | € 703,00 | € 575,90 |
| H | H | | € 547,50 | € 547,50 | € 448,50 |

For fabrics see page 306
Per i tessuti si veda a p. 306

PACKING / Imballo



TECHNICAL DETAILS / Dettagli tecnici

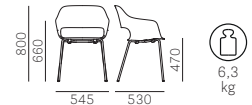

CATAS

BS 5852:2006 (Clause 11 Crib 5)

Babila 2746

SOFT



| SEAT Sedile | BACK Schienale | FRAME Telaio | WHITE/BLACK POWDER COATED Verniciato bianco/nero | CHROMED Cromato | VAT NOT INCLUDED Iva esclusa 22% |
|----------------|-------------------|-----------------|--|--------------------|--|
| C | C | | € 530,00 | € 530,00 | € 434,20 |
| E | E | Ø 11 | € 742,50 | € 742,50 | € 608,40 |
| G | G | | € 711,00 | € 711,00 | € 582,40 |
| H | H | | € 555,50 | € 555,50 | € 455,00 |

For fabrics see page 306
Per i tessuti si veda a p. 306

PACKING / Imballo



TECHNICAL DETAILS / Dettagli tecnici



CATAS

BS 5852:2006 (Clause 11 Crib 5)

Babila 2756

SOFT



| SEAT Sedile | BACK Schienale | FRAME Telaio | ASH Frassino | VAT NOT INCLUDED Iva esclusa 22% |
|----------------|-------------------|--------------------|-----------------|--|
| C | C | FR-N1-AN- GC-BI | € 590,00 | € 483,60 |
| E | E | | € 803,00 | € 657,80 |
| G | G | | € 771,00 | € 631,80 |
| H | H | | € 615,50 | € 504,40 |

For fabrics see page 306
Per i tessuti si veda a p. 306

FINISHES / Finiture



PACKING / Imballo



TECHNICAL DETAILS / Dettagli tecnici

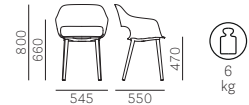

CATAS

BS 5852:2006 (Clause 11 Crib 5)



Babila 2776

SOFT



| SEAT Sedile | BACK Schienale | FRAME Telaio | WHITE/BLACK POWDER COATED Verniciato bianco/nero | VAT NOT INCLUDED Iva esclusa 22% | POLISHED S/STEEL Inox lucidato | VAT NOT INCLUDED Iva esclusa 22% |
|----------------|-------------------|-----------------|--|--|-----------------------------------|--|
| C | C | Ø 680 | € 639,50 | € 523,90 | € 687,00 | € 562,90 |
| E | E | | € 852,00 | € 698,10 | € 899,50 | € 737,10 |
| G | G | | € 820,00 | € 672,10 | € 868,00 | € 711,10 |
| H | H | | € 665,00 | € 544,70 | € 712,50 | € 583,70 |

For fabrics see page 306
Per i tessuti si veda a p. 306

PACKING / Imballo



TECHNICAL DETAILS / Dettagli tecnici

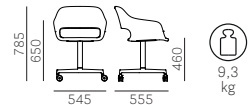

BS 5852:2006 (Clause 11 Crib 5)

Babila 2702



| SEAT Sedile | FRAME Telaio | ASH Frassino | | VAT NOT INCLUDED Iva esclusa 22% |
|--------------------|-----------------|--|-----------------------|--|
| | | WHITE/BLACK POWDER COATED Verniciato bianco/nero | SATINIZED Satinato | |
| FR-N1-AN- GC-BI | H 650 | € 227,00 | | € 185,90 |
| | | | € 274,50 | € 224,90 |

FINISHES / Finiture



PACKING / Imballo



TECHNICAL DETAILS / Dettagli tecnici



CATAS



Babila 2702/A



| SEAT Sedile | FRAME Telaio | ASH Frassino | | | |
|----------------|-----------------|--|--|-----------------------|--|
| | | WHITE/BLACK POWDER COATED Verniciato bianco/nero | VAT NOT INCLUDED Iva esclusa 22% | SATINIZED Satinato | VAT NOT INCLUDED Iva esclusa 22% |
| C | H 680 | € 306,50 | € 250,90 | € 354,00 | € 289,90 |
| E | | € 328,50 | € 269,10 | € 376,00 | € 308,10 |
| G | | € 328,50 | € 269,10 | € 376,00 | € 308,10 |
| H | | € 308,00 | € 252,20 | € 355,50 | € 291,20 |

For fabrics see page 306
Per i tessuti si veda a p. 306

FINISHES / Finiture



PACKING / Imballo



TECHNICAL DETAILS / Dettagli tecnici



BS 5852:2006 (Clause 11 Crib 5)



Babila 2706



| SEAT Sedile | FRAME Telaio | ASH Frassino | | VAT NOT INCLUDED Iva esclusa 22% |
|--------------------|-----------------|--|-----------------------|--|
| | | WHITE/BLACK POWDER COATED Verniciato bianco/nero | SATINIZED Satinato | |
| FR-N1-AN- GC-BI | H 750 | € 227,00 | | € 185,90 |
| | | | € 274,50 | € 224,90 |

FINISHES / Finiture



PACKING / Imballo



TECHNICAL DETAILS / Dettagli tecnici



CATAS



Babila 2706/A



| SEAT Sedile | FRAME Telaio | ASH Frassino | | | |
|----------------|-----------------|--|--|-----------------------|--|
| | | WHITE/BLACK POWDER COATED Verniciato bianco/nero | VAT NOT INCLUDED Iva esclusa 22% | SATINIZED Satinato | VAT NOT INCLUDED Iva esclusa 22% |
| C | H 780 | € 306,50 | € 250,90 | € 354,00 | € 289,90 |
| E | | € 328,50 | € 269,10 | € 376,00 | € 308,10 |
| G | | € 328,50 | € 269,10 | € 376,00 | € 308,10 |
| H | | € 308,00 | € 252,20 | € 355,50 | € 291,20 |

For fabrics see page 306
Per i tessuti si veda a p. 306

FINISHES / Finiture



PACKING / Imballo



TECHNICAL DETAILS / Dettagli tecnici



BS 5852:2006 (Clause 11 Crib 5)



Babila 2747



| SEAT Sedile | BACK Schienale | FRAME Telaio | WHITE/BLACK POWDER COATED Verniciato bianco/nero | CHROMED Cromato | VAT NOT INCLUDED Iva esclusa 22% |
|----------------|-------------------|-----------------|--|--------------------|--|
| PPL | PPL | H645 | € 162,00 | | € 132,60 |
| | | | | € 173,00 | € 141,70 |

PPL FINISHES / Finiture PPL



PACKING / Imballo



TECHNICAL DETAILS / Dettagli tecnici

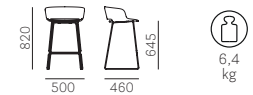

Babila 2748



| SEAT Sedile | BACK Schienale | FRAME Telaio | WHITE/BLACK POWDER COATED Verniciato bianco/nero | CHROMED Cromato | VAT NOT INCLUDED Iva esclusa 22% |
|----------------|-------------------|-----------------|--|--------------------|--|
| PPL | PPL | H745 | € 165,00 | | € 135,20 |
| | | | | € 176,50 | € 144,30 |

PPL FINISHES / Finiture PPL



PACKING / Imballo



TECHNICAL DETAILS / Dettagli tecnici

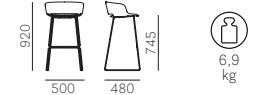

Babila 2757



| SEAT Sedile | BACK Schienale | FRAME Telaio | ASH Frassino | | VAT NOT INCLUDED Iva esclusa 22% |
|----------------|-------------------|-----------------|--|-----------------------|--|
| | | | WHITE/BLACK POWDER COATED Verniciato bianco/nero | SATINIZED Satinato | |
| PPL | PPL | H645 | € 330,00 | | € 270,40 |
| | | | | € 401,50 | € 328,90 |

PPL FINISHES / Finiture PPL



WOODEN FINISHES / Finiture legno



PACKING / Imballo



TECHNICAL DETAILS / Dettagli tecnici



Babila 2758



| SEAT Sedile | BACK Schienale | FRAME Telaio | ASH Frassino | | VAT NOT INCLUDED Iva esclusa 22% |
|----------------|-------------------|-----------------|--|-----------------------|--|
| | | | WHITE/BLACK POWDER COATED Verniciato bianco/nero | SATINIZED Satinato | |
| PPL | PPL | H745 | € 330,00 | | € 270,40 |
| | | | | € 401,50 | € 328,90 |

PPL FINISHES / Finiture PPL



WOODEN FINISHES / Finiture legno



PACKING / Imballo



TECHNICAL DETAILS / Dettagli tecnici



CATAS



Babila 2747/2



| SEAT Sedile | BACK Schienale | FRAME Telaio | WHITE/BLACK POWDER COATED Verniciato bianco/nero | VAT NOT INCLUDED Iva esclusa 22% | CHROMED Cromato | VAT NOT INCLUDED Iva esclusa 22% |
|----------------|-------------------|-----------------|--|--|--------------------|--|
| C | C | H655 | € 493,50 | € 404,30 | € 504,50 | € 413,40 |
| E | E | | € 646,00 | € 529,10 | € 657,00 | € 538,20 |
| G | G | | € 614,00 | € 503,10 | € 625,00 | € 512,20 |
| H | H | | € 509,50 | € 417,30 | € 520,50 | € 426,40 |

For fabrics see page 306
Per i tessuti si veda a p. 306

PACKING / Imballo



TECHNICAL DETAILS / Dettagli tecnici

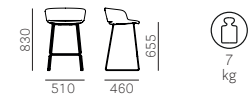

CATAS

Babila 2748/2



| SEAT Sedile | BACK Schienale | FRAME Telaio | WHITE/BLACK POWDER COATED Verniciato bianco/nero | VAT NOT INCLUDED Iva esclusa 22% | CHROMED Cromato | VAT NOT INCLUDED Iva esclusa 22% |
|----------------|-------------------|-----------------|--|--|--------------------|--|
| C | C | H755 | € 496,50 | € 406,90 | € 508,00 | € 416,00 |
| E | E | | € 649,00 | € 531,70 | € 660,00 | € 540,80 |
| G | G | | € 617,00 | € 505,70 | € 628,50 | € 514,80 |
| H | H | | € 512,50 | € 419,90 | € 523,50 | € 429,00 |

For fabrics see page 306
Per i tessuti si veda a p. 306

PACKING / Imballo



TECHNICAL DETAILS / Dettagli tecnici

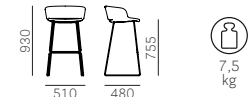

CATAS

Babila 2757/2



| SEAT Sedile | BACK Schienale | FRAME Telaio | ASH Frassino | | | |
|----------------|-------------------|-----------------|--|--|-----------------------|--|
| | | | WHITE/BLACK POWDER COATED Verniciato bianco/nero | VAT NOT INCLUDED Iva esclusa 22% | SATINIZED Satinato | VAT NOT INCLUDED Iva esclusa 22% |
| C | C | H655 | € 661,50 | € 542,10 | € 733,00 | € 600,60 |
| E | E | | € 814,00 | € 666,90 | € 885,00 | € 725,40 |
| G | G | | € 782,00 | € 640,90 | € 853,50 | € 699,40 |
| H | H | | € 677,50 | € 555,10 | € 749,00 | € 613,60 |

For fabrics see page 306
Per i tessuti si veda a p. 306

FINISHES / Finiture



PACKING / Imballo



TECHNICAL DETAILS / Dettagli tecnici



CATAS



Babila 2758/2



| SEAT Sedile | BACK Schienale | FRAME Telaio | ASH Frassino | | | |
|----------------|-------------------|-----------------|--|--|-----------------------|--|
| | | | WHITE/BLACK POWDER COATED Verniciato bianco/nero | VAT NOT INCLUDED Iva esclusa 22% | SATINIZED Satinato | VAT NOT INCLUDED Iva esclusa 22% |
| C | C | H755 | € 661,50 | € 542,10 | € 733,00 | € 600,60 |
| E | E | | € 814,00 | € 666,90 | € 885,00 | € 725,40 |
| G | G | | € 782,00 | € 640,90 | € 853,50 | € 699,40 |
| H | H | | € 677,50 | € 555,10 | € 749,00 | € 613,60 |

For fabrics see page 306
Per i tessuti si veda a p. 306

FINISHES / Finiture



PACKING / Imballo



TECHNICAL DETAILS / Dettagli tecnici



CATAS



Babila Comfort 2749



| SEAT Sedile | BACK Schienale | FRAME Telaio | ASH Frassino | | | |
|----------------|-------------------|-----------------|--|--|---------------------|--|
| | | | WHITE/BLACK POWDER COATED Verniciato bianco/nero | VAT NOT INCLUDED Iva esclusa 22% | TITANIUM Titanio | VAT NOT INCLUDED Iva esclusa 22% |
| C83+C101 | C83+C101 | Ø 12 | € 1.104,00 | € 904,80 | € 1.231,00 | € 1.008,80 |
| E | E | | € 1.464,00 | € 1.199,90 | € 1.591,00 | € 1.303,90 |
| G | G | | € 1.345,00 | € 1.102,40 | € 1.472,00 | € 1.206,40 |
| H | H | | € 1.137,50 | € 932,10 | € 1.264,50 | € 1.036,10 |

For fabrics see page 306
Per i tessuti si veda a p. 306

PACKING / Imballo



TECHNICAL DETAILS / Dettagli tecnici

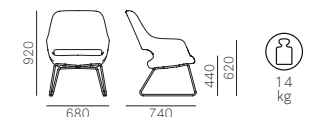

BS 5852:2006 (Clause 11 Crib 5)

Babila Comfort 2759



| SEAT Sedile | BACK Schienale | FRAME Telaio | ASH Frassino | VAT NOT INCLUDED Iva esclusa 22% |
|----------------|-------------------|--------------------|-------------------|--|
| C83+C101 | C83+C101 | | € 1.207,00 | € 989,30 |
| E | E | FR-N1-AN- GC-BI | € 1.567,00 | € 1.284,40 |
| G | G | | € 1.448,50 | € 1.186,90 |
| H | H | | € 1.240,50 | € 1.016,60 |

For fabrics see page 306
Per i tessuti si veda a p. 306

FINISHES / Finiture

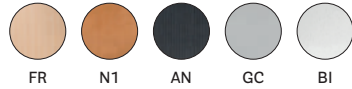

PACKING / Imballo



TECHNICAL DETAILS / Dettagli tecnici

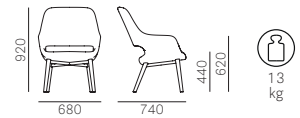

CATAS

BS 5852:2006 (Clause 11 Crib 5)



Babila Comfort 2789



| SEAT Sedile | BACK Schienale | WHITE/BLACK POWDER COATED Verniciato bianco/nero | VAT NOT INCLUDED Iva esclusa 22% | TITANIUM Titanio | VAT NOT INCLUDED Iva esclusa 22% |
|----------------|-------------------|--|--|---------------------|--|
| C83+C101 | C83+C101 | € 1.294,50 | € 1.060,80 | € 1.492,50 | € 1.223,30 |
| E | E | € 1.654,50 | € 1.355,90 | € 1.852,50 | € 1.518,40 |
| G | G | € 1.535,50 | € 1.258,40 | € 1.733,50 | € 1.420,90 |
| H | H | € 1.327,50 | € 1.088,10 | € 1.526,00 | € 1.250,60 |

For fabrics see page 306
Per i tessuti si veda a p. 306

PACKING / Imballo



TECHNICAL DETAILS / Dettagli tecnici

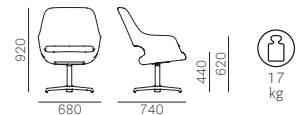

BS 5852:2006 (Clause 11 Crib 5)

Blitz 640



| SEAT Sedile | BACK Schienale | FRAME Telaio | POLYCARBONATE Policarbonato | VAT NOT INCLUDED Iva esclusa 22% |
|----------------|-------------------|-----------------|--------------------------------|--|
| PC | PC | PC | € 157,50 | € 128,70 |

PC FINISHES / Finiture PC

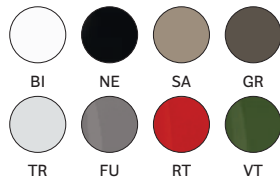

PACKING / Imballo



TECHNICAL DETAILS / Dettagli tecnici

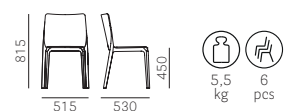

CATAS

Blitz 640.3

Cushion only
Solo cuscino



| SEAT Sedile | FABRIC Tessuto | VAT NOT INCLUDED Iva esclusa 22% |
|----------------|-------------------|--|
| C | € 84,50 | € 68,90 |
| G | € 108,00 | € 88,40 |
| H | € 86,50 | € 70,85 |

For fabrics see page 306
Per i tessuti si veda a p. 306

PACKING / Imballo



TECHNICAL DETAILS / Dettagli tecnici



Box 740



| SEAT Sedile | BACK Schienale | FRAME Telaio | OAK Rovere SATINIZED Satinato | VAT NOT INCLUDED Iva esclusa 22% |
|----------------|-------------------|-----------------|--|--|
| H | H | 20x20 | € 619,00 | € 507,00 |

For fabrics see page 306
Per i tessuti si veda a p. 306

FINISHES / Finiture



PACKING / Imballo



TECHNICAL DETAILS / Dettagli tecnici

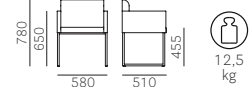

CATAS

Box 741

LOUNGE



| SEAT Sedile | BACK Schienale | FRAME Telaio | OAK Rovere SATINIZED Satinato | VAT NOT INCLUDED Iva esclusa 22% |
|----------------|-------------------|-----------------|--|--|
| H | H | 20x20 | € 714,00 | € 585,00 |

For fabrics see page 306
Per i tessuti si veda a p. 306

FINISHES / Finiture



PACKING / Imballo



TECHNICAL DETAILS / Dettagli tecnici

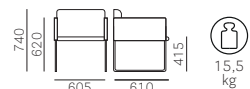

Brera 380



| SEAT Sedile | BACK Schienale | FRAME Telaio | OAK Rovere | VAT NOT INCLUDED Iva esclusa 22% |
|-------------------|-------------------|-------------------|-----------------|--|
| RS-W-N1- GC-BI | RS-W-N1- GC-BI | RS-W-N1- GC-BI | € 309,50 | € 253,50 |

FINISHES / Finiture



PACKING / Imballo



TECHNICAL DETAILS / Dettagli tecnici

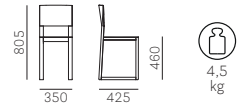

CATAS



Brera 382



| SEAT Sedile | BACK Schienale | FRAME Telaio | OAK Rovere | VAT NOT INCLUDED Iva esclusa 22% |
|-------------------|-------------------|-----------------|-----------------|--|
| RS-W-N1- GC-BI | RS-W-N1- GC-BI | H 650 | € 416,00 | € 340,60 |

FINISHES / Finiture



PACKING / Imballo



TECHNICAL DETAILS / Dettagli tecnici

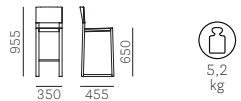

Brera 386



| SEAT Sedile | BACK Schienale | FRAME Telaio | OAK Rovere | VAT NOT INCLUDED Iva esclusa 22% |
|-------------------|-------------------|-----------------|-----------------|--|
| RS-W-N1- GC-BI | RS-W-N1- GC-BI | H 740 | € 474,50 | € 388,70 |

FINISHES / Finiture



PACKING / Imballo



TECHNICAL DETAILS / Dettagli tecnici

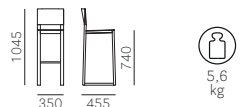

Brera 383



| SEAT Sedile | FRAME Telaio | OAK Rovere | VAT NOT INCLUDED Iva esclusa 22% |
|-------------------|-----------------|-----------------|--|
| RS-W-N1- GC-BI | H 460 | € 238,00 | € 195,00 |

FINISHES / Finiture



PACKING / Imballo



TECHNICAL DETAILS / Dettagli tecnici



CATAS



Brera 387



| SEAT Sedile | FRAME Telaio | OAK Rovere | VAT NOT INCLUDED Iva esclusa 22% |
|-------------------|-----------------|-----------------|--|
| RS-W-N1- GC-BI | H 650 | € 293,50 | € 240,50 |

FINISHES / Finiture



PACKING / Imballo



TECHNICAL DETAILS / Dettagli tecnici



CATAS



Brera 388



| SEAT Sedile | FRAME Telaio | OAK Rovere | VAT NOT INCLUDED Iva esclusa 22% |
|-------------------|-----------------|-----------------|--|
| RS-W-N1- GC-BI | H 750 | € 293,50 | € 240,50 |

FINISHES / Finiture



PACKING / Imballo



TECHNICAL DETAILS / Dettagli tecnici

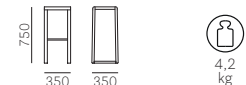

CATAS



Buddy Sofa

Fabric version
Versione in tessuto

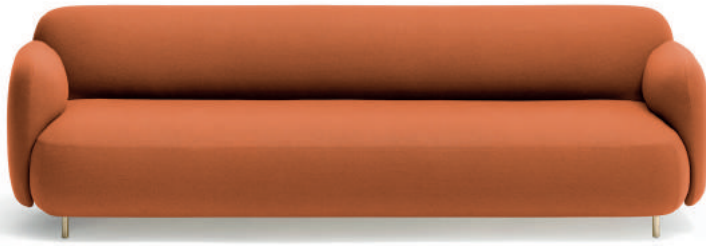

| CODE Codice | SEAT Sedile | BACK Schienale | WHITE/BLACK POWDER COATED Verniciato bianco/nero | ANTIQUE BRASS Ottone antico | VAT NOT INCLUDED Iva esclusa 22% |
|---|--------------------------------------|--------------------------------------|--|--------------------------------|--|
| With armrests / Con braccioli 218 Two seats sofa Divano a due posti | C110+C122 | C110+C122 | € 3.600,50 | € 3.600,50 | € 2.951,00 |
| | E | E | € 4.599,50 | € 4.599,50 | € 3.770,00 |
| | G | G | € 4.314,00 | € 4.314,00 | € 3.536,00 |
| | Excluding / Escluso G01+G09, N01+N05 | Excluding / Escluso G01+G09, N01+N05 | G21+G25, G120+G122, G130+G133, G150+G156 | € 4.536,00 | € 4.536,00 |
| 219 Three seats sofa Divano a tre posti | C110+C122 | C110+C122 | € 4.298,50 | € 4.298,50 | € 3.523,00 |
| | E | E | € 5.440,00 | € 5.440,00 | € 4.459,00 |
| | G | G | € 5.107,00 | € 5.107,00 | € 4.186,00 |
| | Excluding / Escluso G01+G09, N01+N05 | Excluding / Escluso G01+G09, N01+N05 | G21+G25, G120+G122, G130+G133, G150+G156 | € 5.345,00 | € 5.345,00 |
| Without armrests / Senza braccioli 218/2 Two seats sofa Divano a due posti | C110+C122 | C110+C122 | € 2.664,50 | € 2.664,50 | € 2.184,00 |
| | E | E | € 3.362,50 | € 3.362,50 | € 2.756,00 |
| | G | G | € 3.172,00 | € 3.172,00 | € 2.600,00 |
| | Excluding / Escluso G01+G09, N01+N05 | Excluding / Escluso G01+G09, N01+N05 | G21+G25, G120+G122, G130+G133, G150+G156 | € 3.331,00 | € 3.331,00 |
| 219/2 Three seats sofa Divano a tre posti | C110+C122 | C110+C122 | € 3.362,50 | € 3.362,50 | € 2.756,00 |
| | E | E | € 4.203,00 | € 4.203,00 | € 3.445,00 |
| | G | G | € 3.965,00 | € 3.965,00 | € 3.250,00 |
| | Excluding / Escluso G01+G09, N01+N05 | Excluding / Escluso G01+G09, N01+N05 | G21+G25, G120+G122, G130+G133, G150+G156 | € 4.139,50 | € 4.139,50 |

For fabrics see page 306
Per i tessuti si veda a p. 306

TECHNICAL DETAILS / Dettagli tecnici

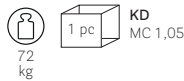
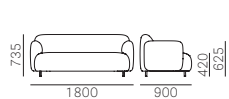

219

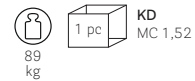
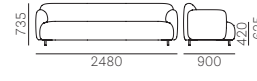

218/2

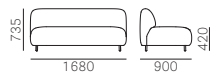

219/2

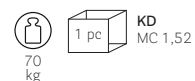
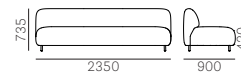

Buddy Sofa

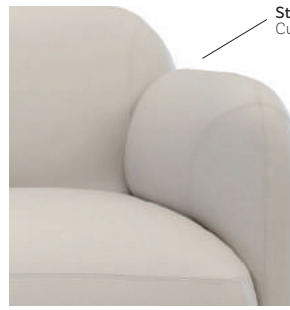
Leather version
Versione in pelleStitching for simil leather and leather version
Cuciture versione in finta e vera pelle

| CODE Codice | SEAT Sedile | BACK Schienale | WHITE/BLACK POWDER COATED Verniciato bianco/nero | ANTIQUE BRASS Ottone anticato | VAT NOT INCLUDED Iva esclusa 22% |
|--|----------------|-------------------|--|--|--|
| With armrests / Con braccioli | | | | | |
| 218 Two seats sofa Divano a due posti | H20+H108 P | H20+H108 P | € 3.854,00 € 5.218,00 | € 3.854,00 € 5.218,00 | € 3.159,00 € 4.277,00 |
| 219 Three seats sofa Divano a tre posti | H20+H108 P | H20+H108 P | € 4.584,00 € 6.344,00 | € 4.584,00 € 6.344,00 | € 3.757,00 € 5.200,00 |
| Without armrests / Senza braccioli | | | | | |
| 218/2 Two seats sofa Divano a due posti | H20+H108 P | H20+H108 P | € 2.887,00 € 3.838,50 | € 2.887,00 € 3.838,50 | € 2.366,00 € 3.146,00 |
| 219/2 Three seats sofa Divano a tre posti | H20+H108 P | H20+H108 P | € 3.616,50 € 4.964,50 | € 3.616,50 € 4.964,50 | € 2.964,00 € 4.069,00 |

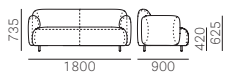
For fabrics see page 306
Per i tessuti si veda a p. 306TECHNICAL DETAILS / Dettagli tecnici
218

219

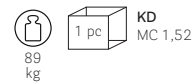
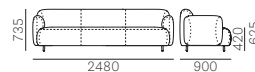

218/2

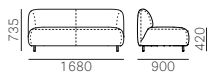

219/2

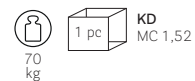
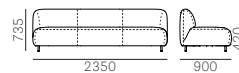

Buddy 210



| SEAT Sedile | FRAME Telaio | WHITE/BLACK POWDER COATED Verniciato bianco/nero | VAT NOT INCLUDED Iva esclusa 22% | ANTIQUE BRASS Ottone anticato | VAT NOT INCLUDED Iva esclusa 22% |
|----------------|-----------------|--|--|----------------------------------|--|
| C | 550x550 H400 | € 536,50 | € 439,40 | € 626,50 | € 513,50 |
| E | | € 699,50 | € 573,30 | € 790,00 | € 647,40 |
| G | | € 699,50 | € 573,30 | € 790,00 | € 647,40 |
| H | | € 558,50 | € 457,60 | € 649,00 | € 531,70 |

For fabrics see page 306
Per i tessuti si veda a p. 306

PACKING / Imballo



TECHNICAL DETAILS / Dettagli tecnici



Buddy 211



| SEAT Sedile | FRAME Telaio | WHITE/BLACK POWDER COATED Verniciato bianco/nero | VAT NOT INCLUDED Iva esclusa 22% | ANTIQUE BRASS Ottone anticato | VAT NOT INCLUDED Iva esclusa 22% |
|----------------|-----------------|--|--|----------------------------------|--|
| C | 550x550 H450 | € 536,50 | € 439,40 | € 626,50 | € 513,50 |
| E | | € 699,50 | € 573,30 | € 790,00 | € 647,40 |
| G | | € 699,50 | € 573,30 | € 790,00 | € 647,40 |
| H | | € 558,50 | € 457,60 | € 649,00 | € 531,70 |

For fabrics see page 306
Per i tessuti si veda a p. 306

PACKING / Imballo



TECHNICAL DETAILS / Dettagli tecnici

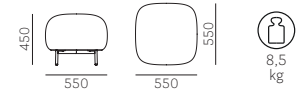

Buddy 212



| SEAT Sedile | FRAME Telaio | WHITE/BLACK POWDER COATED Verniciato bianco/nero | VAT NOT INCLUDED Iva esclusa 22% | ANTIQUE BRASS Ottone anticato | VAT NOT INCLUDED Iva esclusa 22% |
|----------------|-----------------|--|--|----------------------------------|--|
| C | 900x900 H400 | € 866,00 | € 709,80 | € 1.020,00 | € 835,90 |
| E | | € 1.202,50 | € 985,40 | € 1.356,50 | € 1.111,50 |
| G | | € 1.202,50 | € 985,40 | € 1.356,50 | € 1.111,50 |
| H | | € 912,00 | € 747,50 | € 1.066,00 | € 873,60 |

For fabrics see page 306
Per i tessuti si veda a p. 306

PACKING / Imballo



TECHNICAL DETAILS / Dettagli tecnici

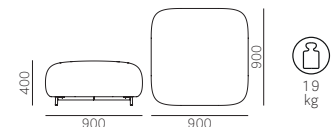

Buddy 213



| SEAT Sedile | FRAME Telaio | WHITE/BLACK POWDER COATED Verniciato bianco/nero | VAT NOT INCLUDED Iva esclusa 22% | ANTIQUE BRASS Ottone anticato | VAT NOT INCLUDED Iva esclusa 22% |
|----------------|-----------------|--|--|----------------------------------|--|
| C | 900x900 H450 | € 866,00 | € 709,80 | € 1.020,00 | € 835,90 |
| E | | € 1.202,50 | € 985,40 | € 1.356,50 | € 1.111,50 |
| G | | € 1.202,50 | € 985,40 | € 1.356,50 | € 1.111,50 |
| H | | € 912,00 | € 747,50 | € 1.066,00 | € 873,60 |

For fabrics see page 306
Per i tessuti si veda a p. 306

PACKING / Imballo



TECHNICAL DETAILS / Dettagli tecnici

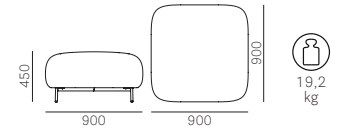

Buddy 214



| SEAT Sedile | FRAME Telaio | WHITE/BLACK POWDER COATED Verniciato bianco/nero | VAT NOT INCLUDED Iva esclusa 22% | ANTIQUE BRASS Ottone anticato | VAT NOT INCLUDED Iva esclusa 22% |
|----------------|------------------|--|--|----------------------------------|--|
| C | 1100x550 H400 | € 771,00 | € 631,80 | € 925,00 | € 757,90 |
| E | | € 1.012,00 | € 829,40 | € 1.166,00 | € 955,50 |
| G | | € 1.012,00 | € 829,40 | € 1.166,00 | € 955,50 |
| H | | € 804,50 | € 659,10 | € 958,00 | € 785,20 |

For fabrics see page 306
Per i tessuti si veda a p. 306

PACKING / Imballo



TECHNICAL DETAILS / Dettagli tecnici

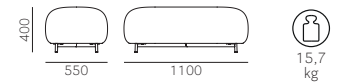

Buddy 215



| SEAT Sedile | FRAME Telaio | WHITE/BLACK POWDER COATED Verniciato bianco/nero | VAT NOT INCLUDED Iva esclusa 22% | ANTIQUE BRASS Ottone anticato | VAT NOT INCLUDED Iva esclusa 22% |
|----------------|------------------|--|--|----------------------------------|--|
| C | 1100x550 H450 | € 771,00 | € 631,80 | € 925,00 | € 757,90 |
| E | | € 1.012,00 | € 829,40 | € 1.166,00 | € 955,50 |
| G | | € 1.012,00 | € 829,40 | € 1.166,00 | € 955,50 |
| H | | € 804,50 | € 659,10 | € 958,00 | € 785,20 |

For fabrics see page 306
Per i tessuti si veda a p. 306

PACKING / Imballo



TECHNICAL DETAILS / Dettagli tecnici

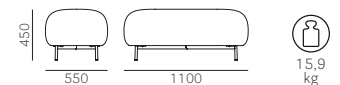

Buddy 210S

| SEAT Sedile | BACK Schienale | FRAME Telaio | WHITE/BLACK POWDER COATED Verniciato bianco/nero | VAT NOT INCLUDED Iva esclusa 22% | ANTIQUÉ BRASS Ottone anticato | VAT NOT INCLUDED Iva esclusa 22% |
|----------------|-------------------|-----------------|--|--|----------------------------------|--|
| C | C | 550x620 H400 | € 1.018,50 | € 834,60 | € 1.163,00 | € 952,90 |
| E | E | | € 1.302,50 | € 1.067,30 | € 1.446,50 | € 1.185,60 |
| G | G | | € 1.302,50 | € 1.067,30 | € 1.446,50 | € 1.185,60 |
| H | H | | € 1.058,00 | € 867,10 | € 1.202,50 | € 985,40 |

For fabrics see page 306
Per i tessuti si veda a p. 306

PACKING / Imballo



TECHNICAL DETAILS / Dettagli tecnici

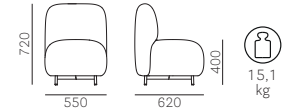

CATAS

Buddy 211S

| SEAT Sedile | BACK Schienale | FRAME Telaio | WHITE/BLACK POWDER COATED Verniciato bianco/nero | VAT NOT INCLUDED Iva esclusa 22% | ANTIQUÉ BRASS Ottone anticato | VAT NOT INCLUDED Iva esclusa 22% |
|----------------|-------------------|-----------------|--|--|----------------------------------|--|
| C | C | 550x620 H450 | € 1.018,50 | € 834,60 | € 1.163,00 | € 952,90 |
| E | E | | € 1.302,50 | € 1.067,30 | € 1.446,50 | € 1.185,60 |
| G | G | | € 1.302,50 | € 1.067,30 | € 1.446,50 | € 1.185,60 |
| H | H | | € 1.058,00 | € 867,10 | € 1.202,50 | € 985,40 |

For fabrics see page 306
Per i tessuti si veda a p. 306

PACKING / Imballo



TECHNICAL DETAILS / Dettagli tecnici

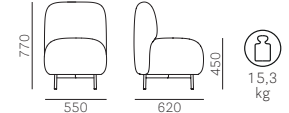

CATAS

Buddy 212S

| SEAT Sedile | BACK Schienale | FRAME Telaio | WHITE/BLACK POWDER COATED Verniciato bianco/nero | VAT NOT INCLUDED Iva esclusa 22% | ANTIQUÉ BRASS Ottone anticato | VAT NOT INCLUDED Iva esclusa 22% |
|----------------|-------------------|-----------------|--|--|----------------------------------|--|
| C | C | 900x970 H400 | € 1.588,00 | € 1.301,30 | € 1.741,50 | € 1.427,40 |
| E | E | | € 2.152,50 | € 1.764,10 | € 2.306,50 | € 1.890,20 |
| G | G | | € 2.152,50 | € 1.764,10 | € 2.306,50 | € 1.890,20 |
| H | H | | € 1.665,50 | € 1.365,00 | € 1.819,50 | € 1.491,10 |

For fabrics see page 306
Per i tessuti si veda a p. 306

PACKING / Imballo



TECHNICAL DETAILS / Dettagli tecnici

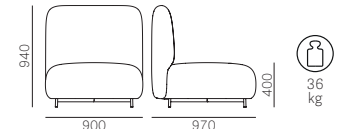

CATAS

Buddy 213S



| SEAT Sedile | BACK Schienale | FRAME Telaio | WHITE/BLACK POWDER COATED Verniciato bianco/nero | VAT NOT INCLUDED Iva esclusa 22% | ANTIQU BRASS Ottone anticato | VAT NOT INCLUDED Iva esclusa 22% |
|----------------|-------------------|-----------------|--|--|---------------------------------|--|
| C | C | 900x970 H450 | € 1.588,00 | € 1.301,30 | € 1.741,50 | € 1.427,40 |
| E | E | | € 2.152,50 | € 1.764,10 | € 2.306,50 | € 1.890,20 |
| G | G | | € 2.152,50 | € 1.764,10 | € 2.306,50 | € 1.890,20 |
| H | H | | € 1.665,50 | € 1.365,00 | € 1.819,50 | € 1.491,10 |

For fabrics see page 306
Per i tessuti si veda a p. 306

PACKING / Imballo



TECHNICAL DETAILS / Dettagli tecnici

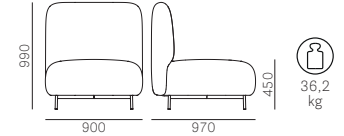

CATAS

Buddy 214S



| SEAT Sedile | BACK Schienale | FRAME Telaio | WHITE/BLACK POWDER COATED Verniciato bianco/nero | VAT NOT INCLUDED Iva esclusa 22% | ANTIQU BRASS Ottone anticato | VAT NOT INCLUDED Iva esclusa 22% |
|----------------|-------------------|------------------|--|--|---------------------------------|--|
| C | C | 1100x620 H400 | € 1.534,00 | € 1.257,10 | € 1.740,00 | € 1.426,10 |
| E | E | | € 1.956,00 | € 1.602,90 | € 2.162,00 | € 1.771,90 |
| G | G | | € 1.956,00 | € 1.602,90 | € 2.162,00 | € 1.771,90 |
| H | H | | € 1.592,50 | € 1.305,20 | € 1.799,00 | € 1.474,20 |

For fabrics see page 306
Per i tessuti si veda a p. 306

PACKING / Imballo



TECHNICAL DETAILS / Dettagli tecnici

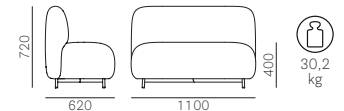

CATAS

Buddy 215S



| SEAT Sedile | BACK Schienale | FRAME Telaio | WHITE/BLACK POWDER COATED Verniciato bianco/nero | VAT NOT INCLUDED Iva esclusa 22% | ANTIQU BRASS Ottone anticato | VAT NOT INCLUDED Iva esclusa 22% |
|----------------|-------------------|------------------|--|--|---------------------------------|--|
| C | C | 1100x620 H450 | € 1.534,00 | € 1.257,10 | € 1.740,00 | € 1.426,10 |
| E | E | | € 1.956,00 | € 1.602,90 | € 2.162,00 | € 1.771,90 |
| G | G | | € 1.956,00 | € 1.602,90 | € 2.162,00 | € 1.771,90 |
| H | H | | € 1.592,50 | € 1.305,20 | € 1.799,00 | € 1.474,20 |

For fabrics see page 306
Per i tessuti si veda a p. 306

PACKING / Imballo



TECHNICAL DETAILS / Dettagli tecnici

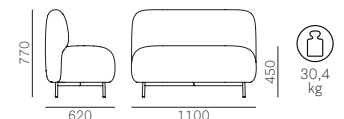

CATAS

Buddy 215S/TT

Turning tablet
Tavoletta girevole



| TOP Ripiano | VAT NOT INCLUDED Iva esclusa 22% |
|--|--|
| <p>€ 246,00</p> <p>For item Per articoli 212, 212S, 213, 213S, 214, 214S, 215, 215S</p> | <p>€ 201,50</p> |

FINISHES / Finiture
Anti-fingerprint finish
Finitura anti-impronta
FNPN_NE

PACKING / Imballo



TECHNICAL DETAILS / Dettagli tecnici



Buddy 212S.3

Cushion only
Solo cuscino



| SEAT Sedile | BACK Schienale | FABRIC Tessuto | VAT NOT INCLUDED Iva esclusa 22% |
|----------------|-------------------|-------------------|--|
| C | C | € 171,50 | € 140,40 |
| E | E | € 244,50 | € 200,20 |
| G | G | € 244,50 | € 200,20 |
| H | H | € 182,50 | € 149,50 |

For fabrics see page 306
Per i tessuti si veda a p. 306

PACKING / Imballo



TECHNICAL DETAILS / Dettagli tecnici

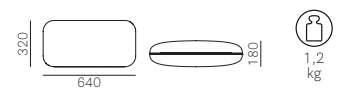

Cube 1401



| SEAT Sedile | FRAME Telaio | WHITE/BLACK POWDER COATED Verniciato bianco/nero | CHROMED Cromato | SATINIZED Satinato | VAT NOT INCLUDED Iva esclusa 22% |
|----------------|-----------------|--|--------------------|-----------------------|--|
| | | € 170,00 | | | € 139,10 |
| A | 25x25 | | € 186,00 | | € 152,10 |
| | | | | € 219,00 | € 179,40 |

For fabrics see page 306
Per i tessuti si veda a p. 306

PACKING / Imballo



TECHNICAL DETAILS / Dettagli tecnici



Cube 1402



| SEAT Sedile | FRAME Telaio | WHITE/BLACK POWDER COATED Verniciato bianco/nero | CHROMED Cromato | SATINIZED Satinato | VAT NOT INCLUDED Iva esclusa 22% |
|----------------|-----------------|--|--------------------|-----------------------|--|
| A | 25x25 | € 152,50 | € 182,50 | € 217,50 | € 124,80 € 149,50 € 178,10 |

For fabrics see page 306
Per i tessuti si veda a p. 306

PACKING / Imballo



TECHNICAL DETAILS / Dettagli tecnici



Cube 1403



| SEAT Sedile | FRAME Telaio | WHITE/BLACK POWDER COATED Verniciato bianco/nero | CHROMED Cromato | SATINIZED Satinato | VAT NOT INCLUDED Iva esclusa 22% |
|----------------|-----------------|--|--------------------|-----------------------|--|
| A | 25x25 | € 149,50 | € 179,50 | € 214,50 | € 122,20 € 146,90 € 175,50 |

For fabrics see page 306
Per i tessuti si veda a p. 306

PACKING / Imballo



TECHNICAL DETAILS / Dettagli tecnici



Day Dream 401



| SEAT Sedile | BACK Schienale | FRAME Telaio | WHITE/BLACK POWDER COATED Verniciato bianco/nero | CHROMED Cromato | VAT NOT INCLUDED Iva esclusa 22% |
|----------------|-------------------|-----------------|--|--------------------|--|
| PC | PC | Ø 11 | € 152,50* | € 160,50 | € 124,80 € 131,30 |

*Powder coated in the same colour of the shell
Verniciato in tinta con la scocca

PC FINISHES / Finiture PC



PACKING / Imballo



TECHNICAL DETAILS / Dettagli tecnici



CATAS

Day Dream 405



| SEAT Sedile | BACK Schienale | FRAME Telaio | WHITE/BLACK POWDER COATED Verniciato bianco/nero | CHROMED Cromato | VAT NOT INCLUDED Iva esclusa 22% |
|----------------|-------------------|-----------------|--|--------------------|--|
| PC | PC | Ø 16 | € 181,00* | € 181,00 | € 148,20 |

*Powder coated in the same colour of the shell
Verniciato in tinta con la scocca

PC FINISHES / Finiture PC



PACKING / Imballo



TECHNICAL DETAILS / Dettagli tecnici



CATAS

Dome 260



| SEAT Sedile | BACK Schienale | FRAME Telaio | POLYPROPYLENE Polipropilene | VAT NOT INCLUDED Iva esclusa 22% |
|----------------|-------------------|-----------------|--------------------------------|--|
| PPL | PPL | PPL | € 98,50 | € 80,60 |

PPL FINISHES / Finiture PPL

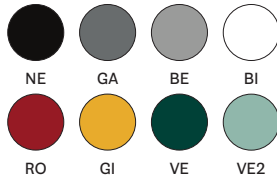

PACKING / Imballo



TECHNICAL DETAILS / Dettagli tecnici



CATAS



PRODUCT CERTIFIED
FOR LOW CHEMICAL
EMISSIONS:
UL.COM/CGG
UL 2818

Dome 261

Perforated
Forata



| SEAT Sedile | BACK Schienale | FRAME Telaio | POLYPROPYLENE Polipropilene | VAT NOT INCLUDED Iva esclusa 22% |
|----------------|-------------------|-----------------|--------------------------------|--|
| PPL | PPL | PPL | € 98,50 | € 80,60 |

PPL FINISHES / Finiture PPL

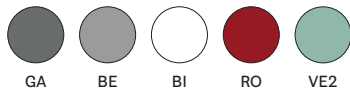

PACKING / Imballo



TECHNICAL DETAILS / Dettagli tecnici



PRODUCT CERTIFIED
FOR LOW CHEMICAL
EMISSIONS:
UL.COM/CGG
UL 2818

Dome 265



| SEAT Sedile | BACK Schienale | FRAME Telaio | POLYPROPYLENE Polipropilene | VAT NOT INCLUDED Iva esclusa 22% |
|----------------|-------------------|-----------------|--------------------------------|--|
| PPL | PPL | PPL | € 114,50 | € 93,60 |

PPL FINISHES / Finiture PPL

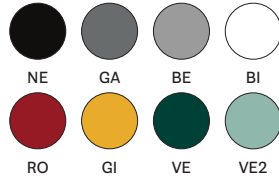

PACKING / Imballo



TECHNICAL DETAILS / Dettagli tecnici

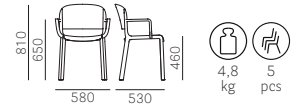

PRODUCT CERTIFIED
FOR LOW CHEMICAL
EMISSIONS:
UL.COM/CGG
UL 2818

Dome 266

Perforated
Forata



| SEAT Sedile | BACK Schienale | FRAME Telaio | POLYPROPYLENE Polipropilene | VAT NOT INCLUDED Iva esclusa 22% |
|----------------|-------------------|-----------------|--------------------------------|--|
| PPL | PPL | PPL | € 114,50 | € 93,60 |

PPL FINISHES / Finiture PPL

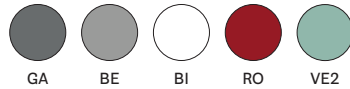

PACKING / Imballo



TECHNICAL DETAILS / Dettagli tecnici

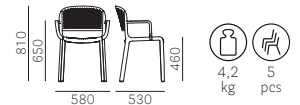

PRODUCT CERTIFIED
FOR LOW CHEMICAL
EMISSIONS:
UL.COM/CGG
UL 2818

Dome 267



| SEAT Sedile | BACK Schienale | FRAME Telaio | POLYPROPYLENE Polipropilene | VAT NOT INCLUDED Iva esclusa 22% |
|----------------|-------------------|-----------------|--------------------------------|--|
| PPL | PPL | PPL H650 | € 113,00 | € 92,30 |

PPL FINISHES / Finiture PPL

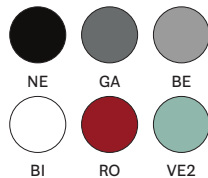

PACKING / Imballo



TECHNICAL DETAILS / Dettagli tecnici



Dome 268



| SEAT Sedile | BACK Schienale | FRAME Telaio | POLYPROPYLENE Polipropilene | VAT NOT INCLUDED Iva esclusa 22% |
|----------------|-------------------|-----------------|--------------------------------|--|
| PPL | PPL | PPL H760 | € 114,50 | € 93,60 |

PPL FINISHES / Finiture PPL

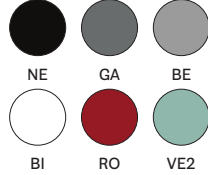

PACKING / Imballo



TECHNICAL DETAILS / Dettagli tecnici

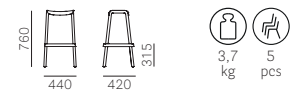

CATAS

Dress 530



| SEAT Sedile | BACK Schienale | FRAME Telaio | OAK Rovere | VAT NOT INCLUDED Iva esclusa 22% |
|----------------|-------------------|-------------------|-----------------|--|
| E | E | | € 580,00 | € 475,15 |
| G | G | RS-W-N1- GC-BI | € 580,00 | € 475,15 |
| H | H | | € 438,00 | € 358,80 |
| P | P | | € 627,50 | € 514,15 |

For fabrics see page 306
Per i tessuti si veda a p. 306

FINISHES / Finiture



PACKING / Imballo



TECHNICAL DETAILS / Dettagli tecnici

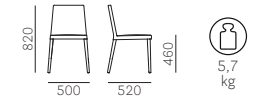

CATAS

Dress 531

High back
Schienale alto



| SEAT Sedile | BACK Schienale | FRAME Telaio | OAK Rovere | VAT NOT INCLUDED Iva esclusa 22% |
|----------------|-------------------|-------------------|-----------------|--|
| E | E | | € 615,50 | € 504,40 |
| G | G | RS-W-N1- GC-BI | € 615,50 | € 504,40 |
| H | H | | € 462,00 | € 378,30 |
| P | P | | € 642,00 | € 525,85 |

For fabrics see page 306
Per i tessuti si veda a p. 306

FINISHES / Finiture



PACKING / Imballo



TECHNICAL DETAILS / Dettagli tecnici

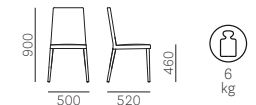

CATAS

Dress 535



| SEAT Sedile | BACK Schienale | FRAME Telaio | OAK Rovere | VAT NOT INCLUDED Iva esclusa 22% |
|----------------|-------------------|-------------------|-----------------|--|
| E | E | RS-W-N1- GC-BI | € 777,50 | € 637,00 |
| G | G | | € 777,50 | € 637,00 |
| H | H | | € 650,50 | € 533,00 |
| P | P | | € 936,00 | € 767,00 |

For fabrics see page 306
Per i tessuti si veda a p. 306

FINISHES / Finiture



PACKING / Imballo



TECHNICAL DETAILS / Dettagli tecnici

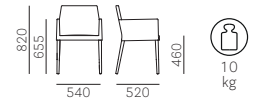

CATAS

Elinor 3755



| SEAT Sedile | BACK Schienale | FRAME Telaio | POLISHED ALUMINIUM Alluminio lucidato | VAT NOT INCLUDED Iva esclusa 22% | BRUSHED ALUMINIUM Alluminio satinato | VAT NOT INCLUDED Iva esclusa 22% |
|-----------------------|-----------------------|-----------------|---|--|--|--|
| G59+G197 G170+G176 | G59+G197 G170+G176 | Ø 810 | € 1.745,00 | € 1.430,00 | € 1.998,50 | € 1.638,00 |
| H20+H108 H60+H64 | H20+H108 H60+H64 | | € 1.610,00 | € 1.319,50 | € 1.864,00 | € 1.527,50 |
| P | P | | € 1.975,00 | € 1.618,50 | € 2.228,50 | € 1.826,50 |

For fabrics see page 306
Per i tessuti si veda a p. 306

PACKING / Imballo



TECHNICAL DETAILS / Dettagli tecnici



CATAS

Enjoy 460



| SEAT Sedile | BACK Schienale | FRAME Telaio | POLYPROPYLENE Polipropilene | VAT NOT INCLUDED Iva esclusa 22% |
|----------------|-------------------|-----------------|--------------------------------|--|
| PPL | PPL | PPL | € 103,50 | € 84,50 |

PPL FINISHES / Finiture PPL



PACKING / Imballo



TECHNICAL DETAILS / Dettagli tecnici

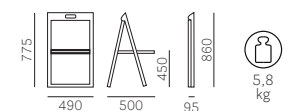

CATAS

Ester 691



| SEAT Sedile | BACK Schienale | BRUSHED BRONZE Bronzo satinato | TITANIUM Titanio | VAT NOT INCLUDED Iva esclusa 22% |
|----------------|-------------------|-----------------------------------|---------------------|--|
| H20+H108 | H20+H108 | € 1.039,00 | € 1.039,00 | € 851,50 |
| P | P | € 1.278,50 | € 1.278,50 | € 1.047,80 |
| P+H | P+H | € 1.326,00 | € 1.326,00 | € 1.086,80 |

For fabrics see page 306
Per i tessuti si veda a p. 306

PACKING / Imballo



TECHNICAL DETAILS / Dettagli tecnici

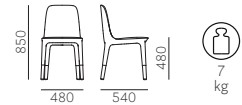

CATAS

BS 5852:2006 (Clause 11 Crib 5)

Ester 690



| SEAT Sedile | BACK Schienale | BRUSHED BRONZE Bronzo satinato | TITANIUM Titanio | VAT NOT INCLUDED Iva esclusa 22% |
|----------------|-------------------|-----------------------------------|---------------------|--|
| H20+H108 | H20+H108 | € 1.221,50 | € 1.221,50 | € 1.001,00 |
| P | P | € 1.496,00 | € 1.496,00 | € 1.225,90 |
| P+H | P+H | € 1.543,50 | € 1.543,50 | € 1.264,90 |

For fabrics see page 306
Per i tessuti si veda a p. 306

PACKING / Imballo



TECHNICAL DETAILS / Dettagli tecnici

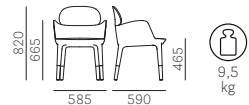

CATAS

BS 5852:2006 (Clause 11 Crib 5)

Ester 695



| SEAT Sedile | BACK Schienale | POLISHED ALUMINIUM Alluminio lucidato | VAT NOT INCLUDED Iva esclusa 22% |
|----------------|-------------------|--|--|
| H20+H108 | H20+H108 | € 1.213,50 | € 994,50 |
| P | P | € 1.492,50 | € 1.223,30 |
| P+H | P+H | € 1.540,50 | € 1.262,30 |

For fabrics see page 306
Per i tessuti si veda a p. 306

PACKING / Imballo



TECHNICAL DETAILS / Dettagli tecnici



BS 5852:2006 (Clause 11 Crib 5)

Ester 695F



| SEAT Sedile | BACK Schienale | POLISHED ALUMINIUM Alluminio lucidato | VAT NOT INCLUDED Iva esclusa 22% |
|----------------|-------------------|--|--|
| H20+H108 | H20+H108 | € 1.245,50 | € 1.020,50 |
| P | P | € 1.524,50 | € 1.249,30 |
| P+H | P+H | € 1.572,00 | € 1.288,30 |

For fabrics see page 306
Per i tessuti si veda a p. 306

PACKING / Imballo



TECHNICAL DETAILS / Dettagli tecnici



BS 5852:2006 (Clause 11 Crib 5)

Ester 696

High back
Schienale alto



| SEAT Sedile | BACK Schienale | POLISHED ALUMINIUM Alluminio lucidato | VAT NOT INCLUDED Iva esclusa 22% |
|----------------|-------------------|--|--|
| H20+H108 | H20+H108 | € 1.335,00 | € 1.093,95 |
| P | P | € 1.642,00 | € 1.345,50 |
| P+H | P+H | € 1.689,50 | € 1.384,50 |

For fabrics see page 306
Per i tessuti si veda a p. 306

PACKING / Imballo



TECHNICAL DETAILS / Dettagli tecnici



BS 5852:2006 (Clause 11 Crib 5)

Ester 696F

High back
Schienale alto



| SEAT Sedile | BACK Schienale | POLISHED ALUMINIUM Alluminio lucidato | VAT NOT INCLUDED Iva esclusa 22% |
|----------------|-------------------|--|--|
| H20+H108 | H20+H108 | € 1.366,50 | € 1.119,95 |
| P | P | € 1.673,50 | € 1.371,50 |
| P+H | P+H | € 1.721,00 | € 1.410,50 |

For fabrics see page 306
Per i tessuti si veda a p. 306

PACKING / Imballo



TECHNICAL DETAILS / Dettagli tecnici



BS 5852:2006 (Clause 11 Crib 5)

Ester 693

POUF



| SEAT Sedile | BACK Schienale | BRUSHED BRONZE Bronzo satinato | TITANIUM Titanio | VAT NOT INCLUDED Iva esclusa 22% |
|----------------|-------------------|-----------------------------------|---------------------|--|
| H20+H108 | H20+H108 | € 795,00 | € 795,00 | € 651,30 |
| P | P | € 1.028,00 | € 1.028,00 | € 842,40 |

For fabrics see page 306
Per i tessuti si veda a p. 306

PACKING / Imballo



TECHNICAL DETAILS / Dettagli tecnici



BS 5852:2006 (Clause 11 Crib 5)

Ester 698



| SEAT Sedile | BACK Schienale | FRAME Telaio | BRUSHED BRONZE Bronzo satinato | TITANIUM Titanio | VAT NOT INCLUDED Iva esclusa 22% |
|----------------|-------------------|-----------------|-----------------------------------|---------------------|--|
| H20+H108 | H20+H108 | | € 1.258,00 | € 1.258,00 | € 1.030,90 |
| P | P | H 750 | € 1.597,50 | € 1.597,50 | € 1.309,10 |
| P+H | P+H | | € 1.645,00 | € 1.645,00 | € 1.348,10 |

For fabrics see page 306
Per i tessuti si veda a p. 306

PACKING / Imballo



TECHNICAL DETAILS / Dettagli tecnici

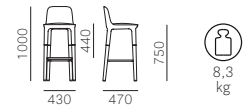

BS 5852:2006 (Clause 11 Crib 5)

Feel 450



| SEAT Sedile | BACK Schienale | FRAME Telaio | OAK Rovere | VAT NOT INCLUDED Iva esclusa 22% |
|-------------------|-------------------|-------------------|---------------|--|
| RS-W-N1- GC-BI | RS-W-N1- GC-BI | RS-W-N1- GC-BI | € 357,00 | € 292,50 |

FINISHES / Finiture



PACKING / Imballo



TECHNICAL DETAILS / Dettagli tecnici

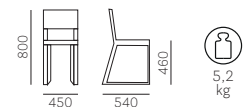

Feel 450/2



| SEAT Sedile | BACK Schienale | FRAME Telaio | OAK Rovere | VAT NOT INCLUDED Iva esclusa 22% |
|-------------------|-------------------|-------------------|-----------------|--|
| RS-W-N1- GC-BI | RS-W-N1- GC-BI | RS-W-N1- GC-BI | € 455,50 | € 373,10 |

FINISHES / Finiture



PACKING / Imballo



TECHNICAL DETAILS / Dettagli tecnici

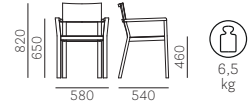

Folk 2930



| SEAT Sedile | BACK Schienale | FRAME Telaio | ASH Frassino | | VAT NOT INCLUDED Iva esclusa 22% |
|--------------------|--------------------|--------------------|--|--|--|
| | | | WHITE/BLACK POWDER COATED Verniciato bianco/nero | POLISHED ALUMINIUM Alluminio lucidato | |
| FR-N1-GC- BI-AN | FR-N1-GC- BI-AN | FR-N1-GC- BI-AN | € 404,50 | | € 331,50 |
| | | | | € 438,00 | € 358,80 |

FINISHES / Finiture

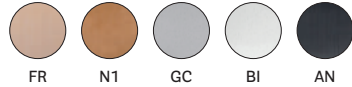

PACKING / Imballo



TECHNICAL DETAILS / Dettagli tecnici

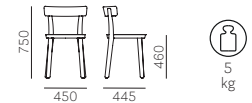

Folk 2920



| SEAT Sedile | BACK Schienale | FRAME Telaio | ASH Frassino | | VAT NOT INCLUDED Iva esclusa 22% |
|-----------------|--------------------|--------------------|--|--|--|
| | | | WHITE/BLACK POWDER COATED Verniciato bianco/nero | POLISHED ALUMINIUM Alluminio lucidato | |
| Cane / Canna | FR-N1-GC- BI-AN | FR-N1-GC- BI-AN | € 479,00 | | € 392,60 |
| | | | | € 512,50 | € 419,90 |

FINISHES / Finiture

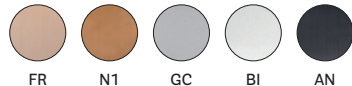

PACKING / Imballo



TECHNICAL DETAILS / Dettagli tecnici

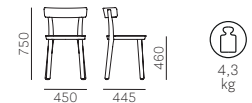

Folk 2940



| SEAT Sedile | BACK Schienale | FRAME Telaio | ASH Frassino | | | |
|------------------------------------|--------------------|--------------------|--|--|---|--|
| | | | WHITE/BLACK POWDER COATED Verniciato bianco/nero | VAT NOT INCLUDED Iva esclusa 22% | POLISHED ALUMINIUM Alluminio lucidato | VAT NOT INCLUDED Iva esclusa 22% |
| C110+C122 | FR-N1-GC- BI-AN | FR-N1-GC- BI-AN | € 416,00 | € 340,60 | € 449,00 | € 367,90 |
| G59+G197 G160+G169 G180+G185 | | | € 452,50 | € 370,50 | € 485,50 | € 397,80 |

For fabrics see page 306
Per i tessuti si veda a p. 306

FINISHES / Finiture



PACKING / Imballo



TECHNICAL DETAILS / Dettagli tecnici

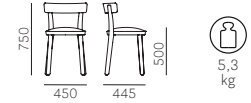

Folk 2936



| SEAT Sedile | BACK Schienale | FRAME Telaio | ASH Frassino | | |
|--------------------|--------------------|-----------------|--|--|--|
| | | | WHITE/BLACK POWDER COATED Verniciato bianco/nero | POLISHED ALUMINIUM Alluminio lucidato | VAT NOT INCLUDED Iva esclusa 22% |
| FR-N1-GC- BI-AN | FR-N1-GC- BI-AN | H650 | € 552,00 | | € 452,40 |
| | | | | € 604,50 | € 495,30 |

FINISHES / Finiture



PACKING / Imballo



TECHNICAL DETAILS / Dettagli tecnici

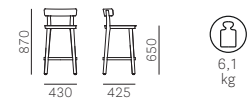

Folk 2926



| SEAT Sedile | BACK Schienale | FRAME Telaio | ASH Frassino | | |
|-----------------|--------------------|-----------------|--|--|--|
| | | | WHITE/BLACK POWDER COATED Verniciato bianco/nero | POLISHED ALUMINIUM Alluminio lucidato | VAT NOT INCLUDED Iva esclusa 22% |
| Cane / Canna | FR-N1-GC- BI-AN | H650 | € 626,50 | | € 513,50 |
| | | | | € 679,00 | € 556,40 |

FINISHES / Finiture



PACKING / Imballo



TECHNICAL DETAILS / Dettagli tecnici

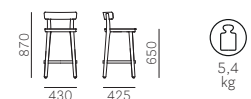

Folk 2946



| SEAT Sedile | BACK Schienale | FRAME Telaio | ASH Frassino | | | |
|------------------------------------|--------------------|-----------------|--|--|---|--|
| | | | WHITE/BLACK POWDER COATED Verniciato bianco/nero | VAT NOT INCLUDED Iva esclusa 22% | POLISHED ALUMINIUM Alluminio lucidato | VAT NOT INCLUDED Iva esclusa 22% |
| C110+C122 | FR-N1-GC- BI-AN | H690 | € 563,50 | € 461,50 | € 615,50 | € 504,40 |
| G59+G197 G160+G169 G180+G185 | | | € 600,00 | € 491,40 | € 652,00 | € 534,30 |

For fabrics see page 306
Per i tessuti si veda a p. 306

FINISHES / Finiture

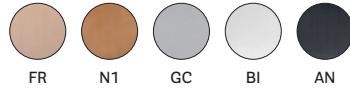

PACKING / Imballo



TECHNICAL DETAILS / Dettagli tecnici



Folk 2937



| SEAT Sedile | BACK Schienale | FRAME Telaio | ASH Frassino | | |
|--------------------|--------------------|-----------------|--|--|--|
| | | | WHITE/BLACK POWDER COATED Verniciato bianco/nero | POLISHED ALUMINIUM Alluminio lucidato | VAT NOT INCLUDED Iva esclusa 22% |
| FR-N1-GC- BI-AN | FR-N1-GC- BI-AN | H750 | € 558,50 | | € 457,60 |
| | | | | € 611,00 | € 500,50 |

FINISHES / Finiture



PACKING / Imballo



TECHNICAL DETAILS / Dettagli tecnici

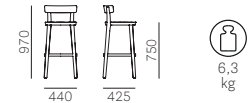

Folk 2927



| SEAT Sedile | BACK Schienale | FRAME Telaio | ASH Frassino | | |
|-----------------|--------------------|-----------------|--|--|--|
| | | | WHITE/BLACK POWDER COATED Verniciato bianco/nero | POLISHED ALUMINIUM Alluminio lucidato | VAT NOT INCLUDED Iva esclusa 22% |
| Cane / Canna | FR-N1-GC- BI-AN | H750 | € 633,00 | | € 518,70 |
| | | | | € 685,50 | € 561,60 |

FINISHES / Finiture



PACKING / Imballo



TECHNICAL DETAILS / Dettagli tecnici

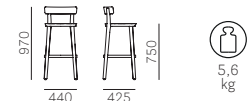

Folk 2947



| SEAT Sedile | BACK Schienale | FRAME Telaio | ASH Frassino | | | |
|------------------------------------|--------------------|-----------------|--|--|---|--|
| | | | WHITE/BLACK POWDER COATED Verniciato bianco/nero | VAT NOT INCLUDED Iva esclusa 22% | POLISHED ALUMINIUM Alluminio lucidato | VAT NOT INCLUDED Iva esclusa 22% |
| C110+C122 | FR-N1-GC- BI-AN | H790 | € 569,50 | € 466,70 | € 622,00 | € 509,60 |
| G59+G197 G160+G169 G180+G185 | | | € 606,00 | € 496,60 | € 658,50 | € 539,50 |

For fabrics see page 306
Per i tessuti si veda a p. 306

FINISHES / Finiture

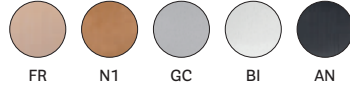

PACKING / Imballo



TECHNICAL DETAILS / Dettagli tecnici

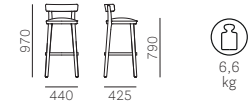

Fox 3725



| SEAT Sedile | BACK Schienale | FRAME Telaio | ASH Frassino | | |
|----------------|-------------------|-----------------|------------------------------------|--|--|
| | | | BLEACHED ASH Frassino sbiancato | BLACK LACQUERED ASH Frassino laccato nero | VAT NOT INCLUDED Iva esclusa 22% |
| PPL | PPL + FR | FR | € 333,50 (BI, SA, BL) | € 333,50 (BL, ML, NE) | € 273,00 |
| PPL | PPL + AN | AN | | | |

PPL FINISHES / Finiture PPL

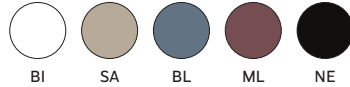

WOODEN FINISHES / Finiture legno



PACKING / Imballo



TECHNICAL DETAILS / Dettagli tecnici



CATAS



Fox 3727



| SEAT Sedile | BACK Schienale | FRAME Telaio | ASH Frassino | | |
|----------------|-------------------|-----------------|------------------------------------|--|--|
| | | | BLEACHED ASH Frassino sbiancato | BLACK LACQUERED ASH Frassino laccato nero | VAT NOT INCLUDED Iva esclusa 22% |
| F04 | F04 + FR | FR | € 730,00 | € 730,00 | € 598,00 |
| F04+F05 | F04+F05 + AN | AN | | | |

GENUINE LEATHER FINISHES / Finiture cuoio naturale



WOODEN FINISHES / Finiture legno



PACKING / Imballo



TECHNICAL DETAILS / Dettagli tecnici



CATAS



Fox 3723



| SEAT Sedile | BACK Schienale | FRAME Telaio | ASH Frassino | VAT NOT INCLUDED Iva esclusa 22% |
|-----------------------------------|-----------------------------------|-----------------|-----------------|--|
| C83+C101 | C83+C101 | | € 745,50 | € 611,00 |
| E | E | FR-AN | € 866,00 | € 709,80 |
| G21+G25 G110+G116 G140+G146 | G21+G25 G110+G116 G140+G146 | | € 866,00 | € 709,80 |

For fabrics see page 306
Per i tessuti si veda a p. 306

FINISHES / Finiture



PACKING / Imballo



TECHNICAL DETAILS / Dettagli tecnici



CATAS



Fox 3726



| SEAT Sedile | BACK Schienale | FRAME Telaio | BEIGE POWDER COATED Verniciato beige | SAND POWDER COATED Verniciato sabbia | BLACK POWDER COATED Verniciato nero | VAT NOT INCLUDED Iva esclusa 22% |
|----------------|-------------------|-----------------|--|--|---|--|
| PPL | PPL + FR | | € 246,00 (BI) | € 246,00 (SA, BL) | | € 201,50 |
| PPL | PPL + AN | Ø 14 | | | € 246,00 (BI, ML, NE) | |

PPL FINISHES / Finiture PPL

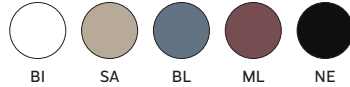

WOODEN FINISHES
Finiture legno



POWDER COATED FINISHES
Finiture verniciato

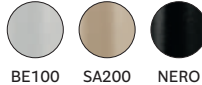

PACKING / Imballo



TECHNICAL DETAILS / Dettagli tecnici

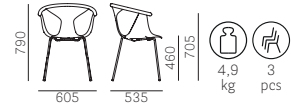

CATAS



Fox 3728



| SEAT Sedile | BACK Schienale | FRAME Telaio | BLACK POWDER COATED Verniciato nero | VAT NOT INCLUDED Iva esclusa 22% |
|----------------|-------------------|-----------------|--|--|
| F04 | F04 + FR | | € 642,50 | € 526,50 |
| F04+F05 | F04+F05 + AN | Ø 14 | € 642,50 | |

GENUINE LEATHER FINISHES / Finiture cuoio naturale

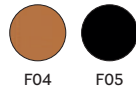

WOODEN FINISHES
Finiture legno



POWDER COATED FINISH
Finitura verniciato



PACKING / Imballo



TECHNICAL DETAILS / Dettagli tecnici



CATAS



Fox 3724



| SEAT Sedile | BACK Schienale | FRAME Telaio | BLACK POWDER COATED Verniciato nero | VAT NOT INCLUDED Iva esclusa 22% |
|-----------------------------------|-----------------------------------|-----------------|--|--|
| C83+C101 | C83+C101 | | € 658,50 | € 539,50 |
| E | E | Ø 14 | € 779,00 | € 638,30 |
| G21+G25 G110+G116 G140+G146 | G21+G25 G110+G116 G140+G146 | | € 779,00 | € 638,30 |

For fabrics see page 306
Per i tessuti si veda a p. 306

FINISHES / Finiture



PACKING / Imballo



TECHNICAL DETAILS / Dettagli tecnici

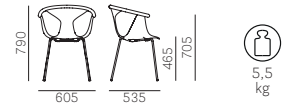

CATAS



Frida 752



| SEAT Sedile | BACK Schienale | FRAME Telaio | OAK Rovere | VAT NOT INCLUDED Iva esclusa 22% |
|-------------------|-------------------|-------------------|-----------------|--|
| RS-W-N1- GC-BI | RS-W-N1- GC-BI | RS-W-N1- GC-BI | € 642,50 | € 526,50 |

FINISHES / Finiture



PACKING / Imballo



TECHNICAL DETAILS / Dettagli tecnici

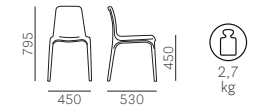

CATAS

Gliss 904

WOOD



| SEAT Sedile | BACK Schienale | FRAME Telaio | ASH Frassino | VAT NOT INCLUDED Iva esclusa 22% |
|----------------|-------------------|-----------------|-----------------|--|
| TP | TP | FR-AN-N1 | € 225,50 | € 184,60 |

TP FINISHES / Finiture TP



WOODEN FINISHES / Finiture legno



PACKING / Imballo



TECHNICAL DETAILS / Dettagli tecnici



CATAS



Gliss 905

WOOD



| SEAT Sedile | BACK Schienale | FRAME Telaio | ASH Frassino | VAT NOT INCLUDED Iva esclusa 22% |
|----------------|-------------------|-----------------|-----------------|--|
| PC | PC | FR-AN-N1 | € 247,50 | € 202,80 |

PC FINISHES / Finiture PC



WOODEN FINISHES / Finiture legno

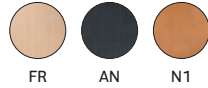

PACKING / Imballo



TECHNICAL DETAILS / Dettagli tecnici



CATAS



Gliss 900.3

Cushion only
Solo cuscino



| SEAT Sedile | FABRIC Tessuto | VAT NOT INCLUDED Iva esclusa 22% |
|----------------|-------------------|--|
| C | € 92,00 | € 75,40 |
| E | € 148,50 | € 121,55 |
| G01+G09 | € 148,50 | € 121,55 |
| H20+H108 | € 98,50 | € 80,60 |

For fabrics see page 306
Per i tessuti si veda a p. 306

PACKING / Imballo



TECHNICAL DETAILS / Dettagli tecnici

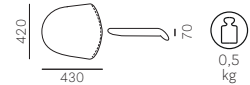

Gliss 900.8

Fabric covering only
Solo vestina



| SEAT Sedile | FABRIC Tessuto | VAT NOT INCLUDED Iva esclusa 22% |
|----------------|-------------------|--|
| C | € 330,00 | € 270,40 |
| E | € 495,00 | € 405,60 |
| G | € 495,00 | € 405,60 |
| H | € 343,00 | € 280,80 |

For technopolymer shell only
Solo per scocca tecnopolimero
For fabrics see page 306
Per i tessuti si veda a p. 306

PACKING / Imballo



TECHNICAL DETAILS / Dettagli tecnici



Gliss 920



| SEAT Sedile | BACK Schienale | FRAME Telaio | CHROMED Cromato | VAT NOT INCLUDED Iva esclusa 22% |
|----------------|-------------------|-----------------|--------------------|--|
| TP | TP | Ø 10 | € 119,00 | € 97,50 |

TP FINISHES / Finiture TP



PACKING / Imballo



TECHNICAL DETAILS / Dettagli tecnici

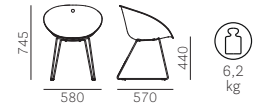

Gliss 921



| SEAT Sedile | BACK Schienale | FRAME Telaio | CHROMED Cromato | VAT NOT INCLUDED Iva esclusa 22% |
|----------------|-------------------|-----------------|--------------------|--|
| PC | PC | Ø 10 | € 151,00 | € 123,50 |

PC FINISHES / Finiture PC



PACKING / Imballo



TECHNICAL DETAILS / Dettagli tecnici

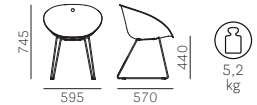

Gliss 950

Gas lift device
Alzata a gas



| SEAT Sedile | BACK Schienale | FRAME Telaio | CHROMED Cromato | VAT NOT INCLUDED Iva esclusa 22% |
|----------------|-------------------|-----------------|--------------------|--|
| TP | TP | Ø 400 | € 301,50 | € 247,00 |

TP FINISHES / Finiture TP



PACKING / Imballo



TECHNICAL DETAILS / Dettagli tecnici

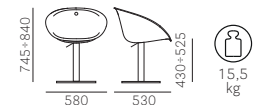

Gliss 951

Gas lift device
Alzata a gas



| SEAT Sedile | BACK Schienale | FRAME Telaio | CHROMED Cromato | VAT NOT INCLUDED Iva esclusa 22% |
|----------------|-------------------|-----------------|--------------------|--|
| PC | PC | Ø 400 | € 324,00 | € 265,20 |

PC FINISHES / Finiture PC

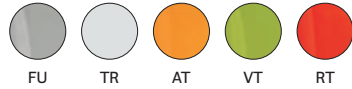

PACKING / Imballo



TECHNICAL DETAILS / Dettagli tecnici

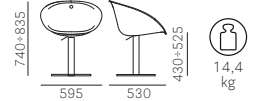

Gliss 952

Gas lift device
Alzata a gas



| SEAT Sedile | BACK Schienale | FRAME Telaio | CHROMED Cromato | VAT NOT INCLUDED Iva esclusa 22% |
|----------------|-------------------|-----------------|--------------------|--|
| PC | PC | Ø 400 | € 324,00 | € 265,20 |

PC FINISH / Finitura PC



PACKING / Imballo



TECHNICAL DETAILS / Dettagli tecnici

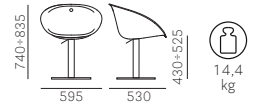

Gliss 960

Gas lift device
Alzata a gas



| SEAT Sedile | BACK Schienale | FRAME Telaio | POLISHED ALUMINIUM Alluminio lucidato | VAT NOT INCLUDED Iva esclusa 22% |
|----------------|-------------------|-----------------|--|--|
| TP | TP | Ø 632 | € 233,50 | € 191,10 |

TP FINISHES / Finiture TP



PACKING / Imballo



TECHNICAL DETAILS / Dettagli tecnici

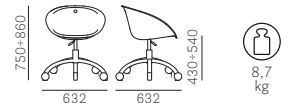

Gliss 961

Gas lift device
Alzata a gas



| SEAT Sedile | BACK Schienale | FRAME Telaio | POLISHED ALUMINIUM Alluminio lucidato | VAT NOT INCLUDED Iva esclusa 22% |
|----------------|-------------------|-----------------|--|--|
| PC | PC | Ø 632 | € 255,50 | € 209,30 |

PC FINISH / Finitura PC



NE

PACKING / Imballo

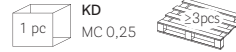

TECHNICAL DETAILS / Dettagli tecnici

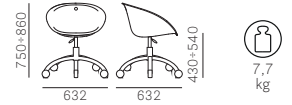

Gliss 968



| SEAT Sedile | BACK Schienale | FRAME Telaio | CHROMED Cromato | VAT NOT INCLUDED Iva esclusa 22% |
|----------------|-------------------|-----------------|--------------------|--|
| PC | PC | Ø 16 | € 220,50 | € 180,70 |

PC FINISHES / Finiture PC

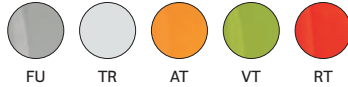

PACKING / Imballo



TECHNICAL DETAILS / Dettagli tecnici

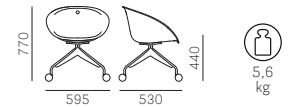

Gliss 904/F

WOOD



| SEAT Sedile | BACK Schienale | FRAME Telaio | ASH Frassino | VAT NOT INCLUDED Iva esclusa 22% |
|----------------|-------------------|-----------------|-----------------|--|
| F01+F09 | F01+F09 | FR-AN-N1 | € 877,50 | € 718,90 |

For fabrics see page 306
Per i tessuti si veda a p. 306

FINISHES / Finiture



PACKING / Imballo



TECHNICAL DETAILS / Dettagli tecnici

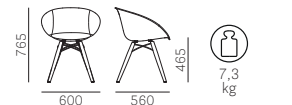

CATAS



Gliss 930



| SEAT Sedile | BACK Schienale | FRAME Telaio | CHROMED Cromato | VAT NOT INCLUDED Iva esclusa 22% |
|----------------|-------------------|-----------------|--------------------|--|
| F01+F09 | F01+F09 | Ø 10 | € 769,50 | € 630,50 |

For fabrics see page 306
Per i tessuti si veda a p. 306

PACKING / Imballo



TECHNICAL DETAILS / Dettagli tecnici

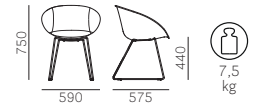

Gliss 966/F

Gas lift device
Alzata a gas



| SEAT Sedile | BACK Schienale | FRAME Telaio | BLACK POWDER COATED Verniciato nero | VAT NOT INCLUDED Iva esclusa 22% |
|----------------|-------------------|-----------------|--|--|
| F01+F09 | F01+F09 | Ø 700 | € 875,50 | € 717,60 |

For fabrics see page 306
Per i tessuti si veda a p. 306

PACKING / Imballo



TECHNICAL DETAILS / Dettagli tecnici

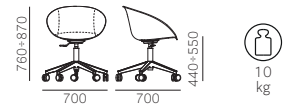

Gliss 902



| SEAT Sedile | BACK Schienale | FRAME Telaio | WHITE/BLACK POWDER COATED Verniciato bianco/nero | CHROMED Cromato | VAT NOT INCLUDED Iva esclusa 22% |
|----------------|-------------------|-----------------|--|--------------------|--|
| PC | PC | Ø 11 H650 | € 162,00* | € 162,00 | € 132,60 |

*Powder coated in the same colour of the shell
Verniciato in tinta con la scocca

PC FINISHES / Finiture PC

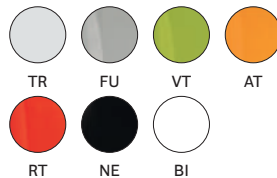

PACKING / Imballo



TECHNICAL DETAILS / Dettagli tecnici

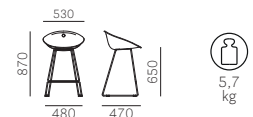

Gliss 906



| SEAT Sedile | BACK Schienale | FRAME Telaio | WHITE/BLACK POWDER COATED Verniciato bianco/nero | CHROMED Cromato | VAT NOT INCLUDED Iva esclusa 22% |
|----------------|-------------------|-----------------|--|--------------------|--|
| PC | PC | Ø 11 H750 | € 178,00* | € 178,00 | € 145,60 |

*Powder coated in the same colour of the shell
Verniciato in tinta con la scocca

PC FINISHES / Finiture PC

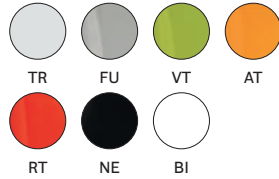

PACKING / Imballo



TECHNICAL DETAILS / Dettagli tecnici

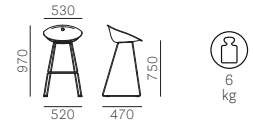

CATAS

Gliss 970

Gas lift device
Alzata a gas



| SEAT Sedile | BACK Schienale | FRAME Telaio | CHROMED Cromato | VAT NOT INCLUDED Iva esclusa 22% |
|----------------|-------------------|-------------------|--------------------|--|
| PC | PC | Ø 400 H600+860 | € 365,00 | € 299,00 |

PC FINISHES / Finiture PC

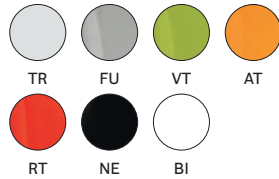

PACKING / Imballo



TECHNICAL DETAILS / Dettagli tecnici

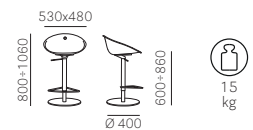

CATAS

Gliss 340

LOUNGE



| SEAT Sedile | BACK Schienale | FRAME Telaio | WHITE POWDER COATED Verniciato bianco | CHROMED Cromato | VAT NOT INCLUDED Iva esclusa 22% |
|----------------|-------------------|-----------------|---|--------------------|--|
| TP | TP | Ø 12 | € 205,00 | € 205,00 | € 167,70 |

TP FINISHES / Finiture TP



PACKING / Imballo



TECHNICAL DETAILS / Dettagli tecnici

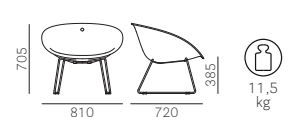

CATAS

Gliss 350

SWING



| SEAT Sedile | BACK Schienale | FRAME Telaio | CHROMED Cromato | VAT NOT INCLUDED Iva esclusa 22% |
|----------------|-------------------|-----------------|--------------------|--|
| TP | TP | Ø 12 | € 319,00 | € 261,30 |

TP FINISHES / Finiture TP



WOODEN FINISHES / Finiture legno



PACKING / Imballo



TECHNICAL DETAILS / Dettagli tecnici

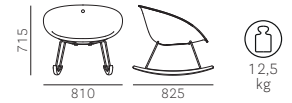

Gliss 360

LOUNGE



| SEAT Sedile | BACK Schienale | WHITE/BLACK POWDER COATED Verniciato bianco/nero | VAT NOT INCLUDED Iva esclusa 22% |
|----------------|-------------------|--|--|
| TP | TP | € 374,50 | € 306,80 |

TP FINISHES / Finiture TP



PACKING / Imballo



TECHNICAL DETAILS / Dettagli tecnici

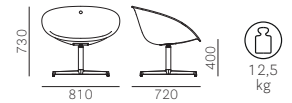

Gliss 340/3

Fabric covering only
Solo vestina



| SEAT Sedile | FABRIC Tessuto | VAT NOT INCLUDED Iva esclusa 22% |
|----------------|-------------------|--|
| C | € 366,00 | € 299,65 |
| E | € 549,00 | € 449,80 |
| G | € 549,00 | € 449,80 |
| H | € 380,00 | € 311,35 |

For technopolymer shell only
Solo per scocca tecnopolimero
For fabrics see page 306
Per i tessuti si veda a p. 306

PACKING / Imballo



TECHNICAL DETAILS / Dettagli tecnici



Gliss 341

LOUNGE



| SEAT Sedile | BACK Schienale | FRAME Telaio | CHROMED Cromato | VAT NOT INCLUDED Iva esclusa 22% |
|----------------|-------------------|-----------------|--------------------|--|
| F01+F09 | F01+F09 | Ø 12 | € 1.228,00 | € 1.006,20 |

For fabrics see page 306
Per i tessuti si veda a p. 306

PACKING / Imballo



TECHNICAL DETAILS / Dettagli tecnici

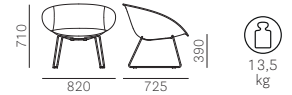

CATAS

Gliss 351

SWING



| SEAT Sedile | BACK Schienale | FRAME Telaio | CHROMED Cromato | VAT NOT INCLUDED Iva esclusa 22% |
|----------------|-------------------|-----------------|--------------------|--|
| F01+F09 | F01+F09 | Ø 12 | € 1.342,00 | € 1.099,80 |

For fabrics see page 306
Per i tessuti si veda a p. 306

WOODEN FINISHES / Finiture legno



FR

PACKING / Imballo



TECHNICAL DETAILS / Dettagli tecnici

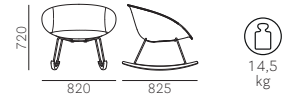

Gliss 361

LOUNGE



| SEAT Sedile | BACK Schienale | FRAME Telaio | WHITE/BLACK POWDER COATED Verniciato bianco/nero | VAT NOT INCLUDED Iva esclusa 22% |
|----------------|-------------------|-----------------|--|--|
| F01+F09 | F01+F09 | Ø 820 | € 1.397,50 | € 1.145,30 |

For fabrics see page 306
Per i tessuti si veda a p. 306

PACKING / Imballo



TECHNICAL DETAILS / Dettagli tecnici

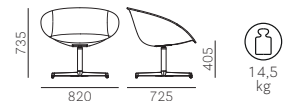

Gossip 620



| SEAT Sedile | BACK Schienale | FRAME Telaio | POLYCARBONATE Policarbonato | VAT NOT INCLUDED Iva esclusa 22% |
|----------------|-------------------|-----------------|--------------------------------|--|
| PC | PC | PC | € 157,50 | € 128,70 |

PC FINISHES / Finiture PC

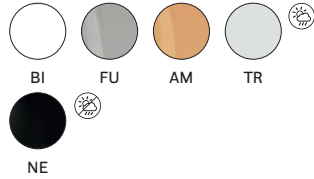

PACKING / Imballo



TECHNICAL DETAILS / Dettagli tecnici

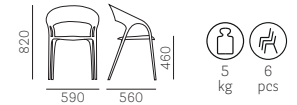

Grace 411



| SEAT Sedile | BACK Schienale | FRAME Telaio | WHITE/BLACK/ORANGE POWDER COATED Verniciato bianco/nero/arancio | CHROMED Cromato | VAT NOT INCLUDED Iva esclusa 22% |
|----------------|-------------------|-----------------|---|--------------------|--|
| PPL | PPL | Ø 11 | € 121,00* | € 121,00 | € 98,80 |

*Powder coated in the same colour of the shell
Verniciato in tinta con la scocca

PPL FINISHES / Finiture PPL



PACKING / Imballo



TECHNICAL DETAILS / Dettagli tecnici

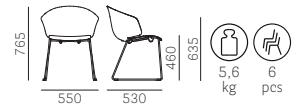

Happy 490



| SEAT Sedile | FRAME Telaio | POLYPROPYLENE Polipropilene | VAT NOT INCLUDED Iva esclusa 22% |
|----------------|-----------------|--------------------------------|--|
| PPL | PPL H 750 | € 103,50 | € 84,50 |

PPL FINISHES / Finiture PPL



PACKING / Imballo



TECHNICAL DETAILS / Dettagli tecnici



Happy 491



| SEAT Sedile | FRAME Telaio | POLYPROPYLENE Polipropilene | VAT NOT INCLUDED Iva esclusa 22% |
|----------------|-----------------|--------------------------------|--|
| PPL | PPL H 450 | € 70,00 | € 57,20 |

PPL FINISHES / Finiture PPL



PACKING / Imballo



TECHNICAL DETAILS / Dettagli tecnici



Héra 2865



| SEAT Sedile | BACK Schienale | FRAME Telaio | ASH Frassino | VAT NOT INCLUDED Iva esclusa 22% | WALNUT (N) Noce | VAT NOT INCLUDED Iva esclusa 22% |
|---|-------------------|-----------------|-------------------|--|--------------------|--|
| E | | | € 947,00 | € 776,10 | € 1.045,50 | € 856,70 |
| G | | | € 947,00 | € 776,10 | € 1.045,50 | € 856,70 |
| Excluding / Escluso G01+G09, G120+G122, G130+G133 | | | | | | |
| H40+H53 | FR-N | FR-N | € 883,50 | € 724,10 | € 982,00 | € 804,70 |
| N | | | € 967,50 | € 793,00 | € 1.066,00 | € 873,60 |
| P | | | € 1.105,50 | € 906,10 | € 1.204,00 | € 986,70 |

For fabrics see page 306
Per i tessuti si veda a p. 306

FINISHES / Finiture



PACKING / Imballo



TECHNICAL DETAILS / Dettagli tecnici



Host 200

Sofa unit
Divano



| SEAT Sedile | BACK Schienale | FRAME Telaio | CHROMED Cromato | VAT NOT INCLUDED Iva esclusa 22% |
|-----------------------------|-------------------|-----------------|--------------------|--|
| C | C | | € 1.040,50 | € 852,80 |
| Excluding / Escluso C90+C95 | | | | |
| E | E | | € 1.339,00 | € 1.097,20 |
| G | G | Ø 16 | € 1.339,00 | € 1.097,20 |
| H | H | | € 1.063,00 | € 871,00 |

For fabrics see page 306
Per i tessuti si veda a p. 306
Couple of linking devices included
Inclusa una coppia di ganci di collegamento
(Item / Art. 200/G_NE)

PACKING / Imballo



TECHNICAL DETAILS / Dettagli tecnici

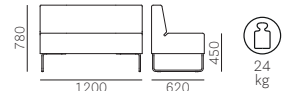

Host 201

Single seat unit
Seduta singola



| SEAT Sedile | BACK Schienale | FRAME Telaio | CHROMED Cromato | VAT NOT INCLUDED Iva esclusa 22% |
|----------------------------------|-------------------|-----------------|--------------------|--|
| C Excluding / Escluso C90+C95 | C | Ø 16 | € 634,50 | € 520,00 |
| E | E | | € 818,50 | € 670,80 |
| G | G | | € 818,50 | € 670,80 |
| H | H | | € 649,00 | € 531,70 |

For fabrics see page 306
Per i tessuti si veda a p. 306

Couple of linking devices included
Inclusa una coppia di ganci di collegamento
(Item / Art. 200/G_NE)

PACKING / Imballo



TECHNICAL DETAILS / Dettagli tecnici

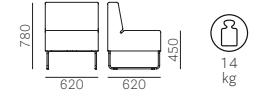

Host 202

Corner unit
Angolare



| SEAT Sedile | BACK Schienale | FRAME Telaio | CHROMED Cromato | VAT NOT INCLUDED Iva esclusa 22% |
|----------------------------------|-------------------|-----------------|--------------------|--|
| C Excluding / Escluso C90+C95 | C | Ø 16 | € 837,50 | € 686,40 |
| E | E | | € 1.067,50 | € 874,90 |
| G | G | | € 1.067,50 | € 874,90 |
| H | H | | € 855,00 | € 700,70 |

For fabrics see page 306
Per i tessuti si veda a p. 306

Couple of linking devices included
Inclusa una coppia di ganci di collegamento
(Item / Art. 200/G_NE)

PACKING / Imballo



TECHNICAL DETAILS / Dettagli tecnici

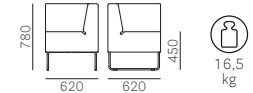

Host 203

Pouf



| SEAT Sedile | FRAME Telaio | CHROMED Cromato | VAT NOT INCLUDED Iva esclusa 22% |
|----------------------------------|-----------------|--------------------|--|
| C Excluding / Escluso C90+C95 | Ø 16 | € 504,50 | € 413,40 |
| E | | € 607,50 | € 497,90 |
| G | | € 607,50 | € 497,90 |
| H | | € 512,50 | € 419,90 |

For fabrics see page 306
Per i tessuti si veda a p. 306

Couple of linking devices included
Inclusa una coppia di ganci di collegamento
(Item / Art. 200/G_NE)

PACKING / Imballo



TECHNICAL DETAILS / Dettagli tecnici



Host lounge 790



| SEAT Sedile | BACK Schienale | FRAME Telaio | BRUSHED S/STEEL Inox satinato | VAT NOT INCLUDED Iva esclusa 22% |
|----------------|-------------------|-----------------|----------------------------------|--|
| PET | PET | Ø 16 | € 420,50 (AISI 316) | € 344,50 |

Couple of linking devices included / Inclusa una coppia di ganci di collegamento (Item / Art. 790/G_NE)

PET FINISHES / Finiture PET

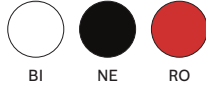

PACKING / Imballo



TECHNICAL DETAILS / Dettagli tecnici

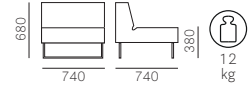

Host lounge 792



| SEAT Sedile | FRAME Telaio | BRUSHED S/STEEL Inox satinato | VAT NOT INCLUDED Iva esclusa 22% |
|----------------|-----------------|----------------------------------|--|
| PET | Ø 16 | € 373,00 (AISI 316) | € 305,50 |

Couple of linking devices included / Inclusa una coppia di ganci di collegamento (Item / Art. 790/G_NE)

PET FINISHES / Finiture PET

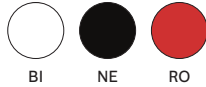

PACKING / Imballo



TECHNICAL DETAILS / Dettagli tecnici

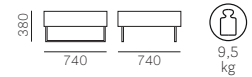

Ice 800



| SEAT Sedile | BACK Schienale | FRAME Telaio | ANODIZED ALUMINIUM Alluminio anodizzato | VAT NOT INCLUDED Iva esclusa 22% |
|----------------|-------------------|-----------------|--|--|
| PPL | PPL | Ø 28 | € 81,00 | € 66,30 |

PPL FINISHES / Finiture PPL

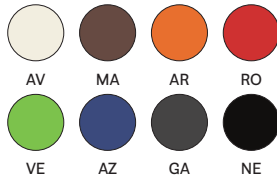

PACKING / Imballo



TECHNICAL DETAILS / Dettagli tecnici



CATAS

Ice 850



| SEAT Sedile | BACK Schienale | FRAME Telaio | ANODIZED ALUMINIUM Alluminio anodizzato | VAT NOT INCLUDED Iva esclusa 22% |
|----------------|-------------------|-----------------|--|--|
| PPL | PPL | Ø 28 | € 119,00 | € 97,50 |

PPL FINISHES / Finiture PPL

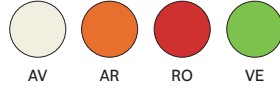

PACKING / Imballo



TECHNICAL DETAILS / Dettagli tecnici

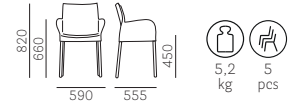

CATAS

Ikon bench B863_1L

Single linear unit
Lineare singola



| TOP Ripiano | FRAME Telaio | PRICE Prezzo | VAT NOT INCLUDED Iva esclusa 22% |
|---------------------|-----------------|-----------------|--|
| 159x38CFP BIANCO | BI | € 566,50 | € 464,10 |
| 159x38COP NERO | NE | € 471,50 | € 386,10 |

Floor fixing kit (for each single base): surcharge € 111,50 (€ 91,00 vat not included) - item B863_FIX
Kit di fissaggio a terra per singola base: supplemento € 111,50 (€ 91,00 iva esclusa) - art. B863_FIX

PPL FINISHES / Finiture PPL



TECHNICAL DETAILS / Dettagli tecnici

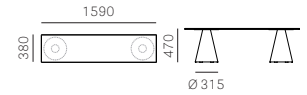

Ikon bench B863_1C

Single curved unit
Curva singola



| TOP Ripiano | FRAME Telaio | PRICE Prezzo | VAT NOT INCLUDED Iva esclusa 22% |
|----------------------|-----------------|-----------------|--|
| R140x38CFP BIANCO | BI | € 1.053,50 | € 863,20 |
| R140x38COP NERO | NE | € 866,00 | € 709,80 |

Floor fixing kit (for each single base): surcharge € 111,50 (€ 91,00 vat not included) - item B863_FIX
Kit di fissaggio a terra per singola base: supplemento € 111,50 (€ 91,00 iva esclusa) - art. B863_FIX

PPL FINISHES / Finiture PPL



TECHNICAL DETAILS / Dettagli tecnici

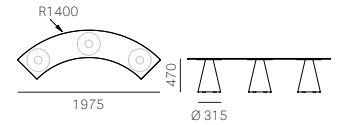

Ikon bench B863.4

For single linear unit
Per moduli lineari

Cushion only
Solo cuscino



| SEAT Sedile | PRICE Prezzo | VAT NOT INCLUDED Iva esclusa 22% |
|----------------|-----------------|--|
| C | € 146,00 | € 119,60 |
| G | € 217,50 | € 178,10 |
| H | € 149,50 | € 122,20 |

For fabrics see page 306
Per i tessuti si veda a p. 306

Price for single cushion
Prezzo per singolo cuscino

PACKING / Imballo



TECHNICAL DETAILS / Dettagli tecnici



Examples of IKON bench combinations

Esempi di configurazioni IKON bench

B863_1L

BI € 566,50
 Vat not included € 464,10
 NE € 471,50
 Vat not included € 386,10

**B863_2L**

BI € 1.010,50
 Vat not included € 828,10
 NE € 820,00
 Vat not included € 672,10

**B863_3L**

BI € 1.454,50
 Vat not included € 1.192,10
 NE € 1.169,00
 Vat not included € 958,10

**B863_4L**

BI € 1.898,50
 Vat not included € 1.556,10
 NE € 1.518,00
 Vat not included € 1.244,10

**B863_4C**

BI € 3.846,50
 Vat not included € 3.152,50
 NE € 3.097,50
 Vat not included € 2.538,90

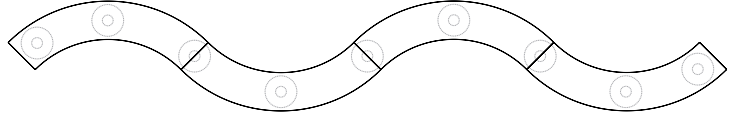
**B863_1C**

BI € 1.053,50
 Vat not included € 863,20
 NE € 866,00
 Vat not included € 709,80

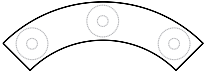
**B863_2C**

BI € 1.984,50
 Vat not included € 1.626,30
 NE € 1.610,00
 Vat not included € 1.319,50

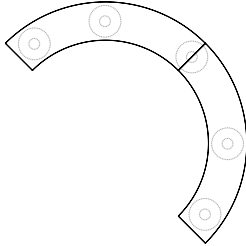
**B863_3C**

BI € 2.915,50
 Vat not included € 2.389,40
 NE € 2.354,00
 Vat not included € 1.929,20

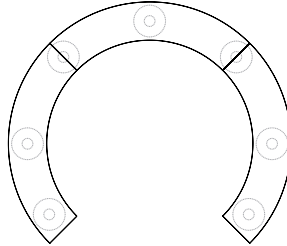
**B863_LC**

BI € 1.497,50
 Vat not included € 1.227,20
 NE € 1.215,00
 Vat not included € 995,80

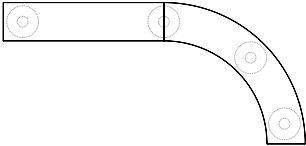
**B863_LCC**

BI € 2.428,50
 Vat not included € 1.990,30
 NE € 1.959,00
 Vat not included € 1.605,50

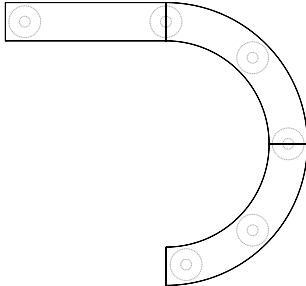
**B863_CLC**

BI € 2.428,50
 Vat not included € 1.990,30
 NE € 1.959,00
 Vat not included € 1.605,50

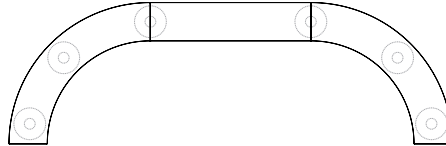
**B863_LLC**

BI € 1.941,50
 Vat not included € 1.591,20
 NE € 1.564,00
 Vat not included € 1.281,80

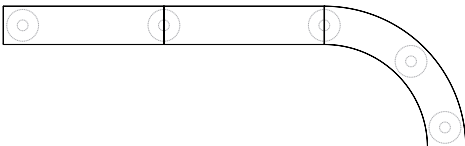
**B863_LCL**

BI € 1.941,50
 Vat not included € 1.591,20
 NE € 1.564,00
 Vat not included € 1.281,80

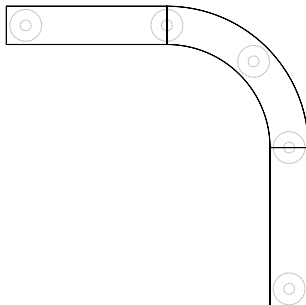

Examples of IKON bench combinations

Esempi di configurazioni IKON bench

B863_LLLC

BI € 2.385,50
 Vat not included € 1.955,20
 NE € 1.913,00
 Vat not included € 1.567,80

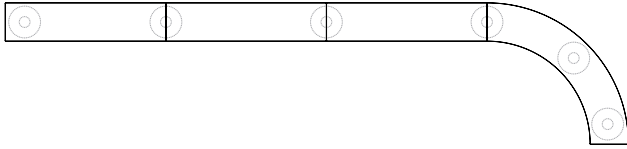

B863_LLCL

BI € 2.385,50
 Vat not included € 1.955,20
 NE € 1.913,00
 Vat not included € 1.567,80

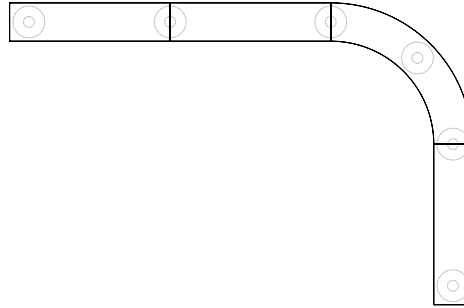

B863_CCCL

BI € 3.359,50
 Vat not included € 2.753,40
 NE € 2.703,00
 Vat not included € 2.215,20

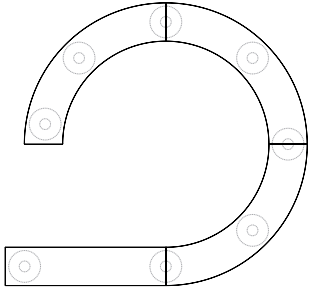

B863_CCLC

BI € 3.359,50
 Vat not included € 2.753,40
 NE € 2.703,00
 Vat not included € 2.215,20

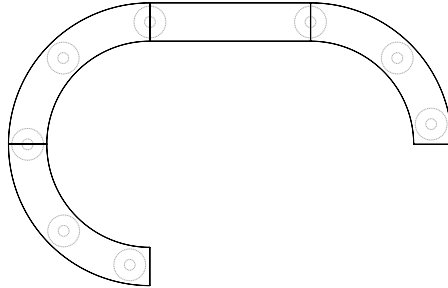

B863_CCLL

BI € 2.872,50
 Vat not included € 2.354,30
 NE € 2.308,00
 Vat not included € 1.891,50

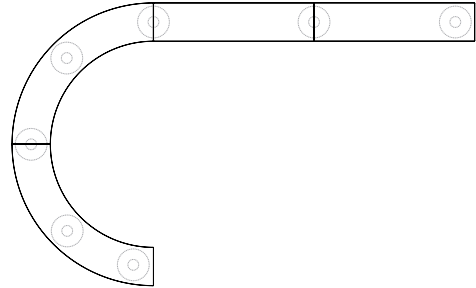

B863_LCCL

BI € 2.872,50
 Vat not included € 2.354,30
 NE € 2.308,00
 Vat not included € 1.891,50

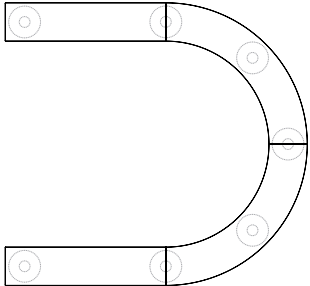

B863_CLLC

BI € 2.872,50
 Vat not included € 2.354,30
 NE € 2.308,00
 Vat not included € 1.891,50

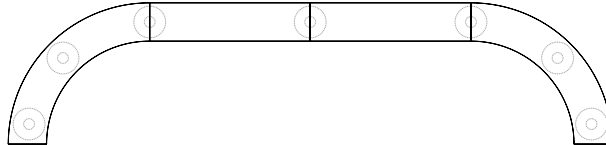

B863_CLCL

BI € 2.872,50
 Vat not included € 2.354,30
 NE € 2.308,00
 Vat not included € 1.891,50

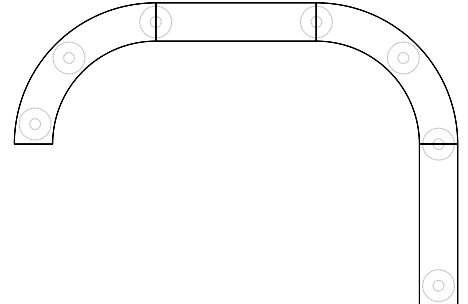

B863C_CLCCLC

BI € 4.614,00
 Vat not included € 3.781,70
 NE € 3.675,00
 Vat not included € 3.012,10

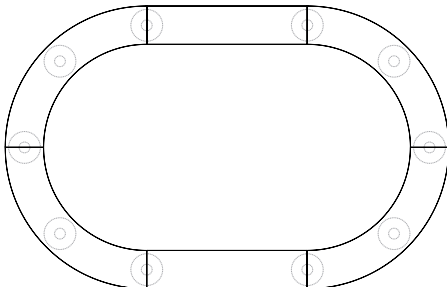

B863C_CLCLCLCL

BI € 5.502,00
 Vat not included € 4.509,70
 NE € 4.373,00
 Vat not included € 3.584,10

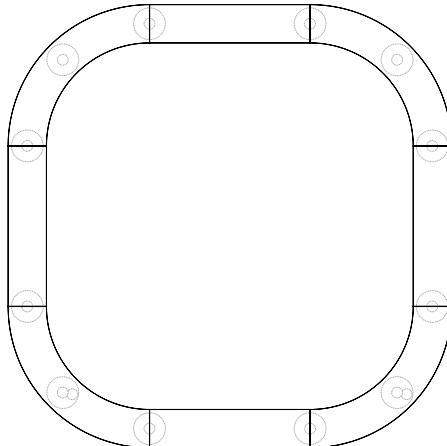

B863C_4C

BI € 3.726,00
 Vat not included € 3.053,70
 NE € 2.977,00
 Vat not included € 2.440,10

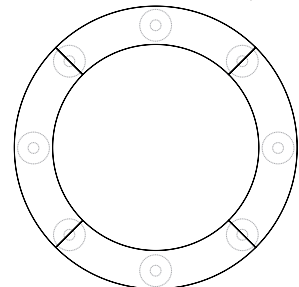

Inga 5613



| SEAT Sedile | BACK Schienale | FRAME Telaio | WHITE/BLACK POWDER COATED Verniciato bianco/nero | CHROMED Cromato | VAT NOT INCLUDED Iva esclusa 22% |
|----------------|-------------------|-----------------|--|--------------------|--|
| RS-W-AN | RS-W-AN | Ø 16 | € 186,00 | € 186,00 | € 152,10 |

FINISHES / Finiture



PACKING / Imballo



TECHNICAL DETAILS / Dettagli tecnici



Inga 5619



| SEAT Sedile | BACK Schienale | FRAME Telaio | WHITE/BLACK POWDER COATED Verniciato bianco/nero | CHROMED Cromato | VAT NOT INCLUDED Iva esclusa 22% |
|----------------|-------------------|-----------------|--|--------------------|--|
| RS-W-AN | RS-W-AN | Ø 10 | € 193,50 | € 186,00 | € 158,60 |
| | | | | € 186,00 | € 152,10 |

FINISHES / Finiture



PACKING / Imballo



TECHNICAL DETAILS / Dettagli tecnici

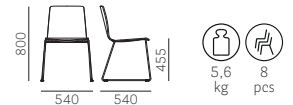

Inga 5663



| SEAT Sedile | BACK Schienale | FRAME Telaio | WHITE/BLACK POWDER COATED Verniciato bianco/nero | CHROMED Cromato | VAT NOT INCLUDED Iva esclusa 22% |
|----------------|-------------------|-----------------|--|--------------------|--|
| F01+F09 | F01+F09 | Ø 16 | € 357,00 | € 357,00 | € 292,50 |
| F11+F19 | F11+F19 | | € 230,00 | € 230,00 | € 188,50 |

Matching stitches
Cuciture in tinta
For fabrics see page 306
Per i tessuti si veda a p. 306

PACKING / Imballo



TECHNICAL DETAILS / Dettagli tecnici

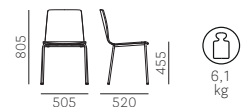

Inga 5669



| SEAT Sedile | BACK Schienale | FRAME Telaio | WHITE/BLACK POWDER COATED Verniciato bianco/nero | VAT NOT INCLUDED Iva esclusa 22% | CHROMED Cromato | VAT NOT INCLUDED Iva esclusa 22% |
|----------------|-------------------|-----------------|--|--|--------------------|--|
| F01+F09 | F01+F09 | Ø 10 | € 365,00 | € 299,00 | € 357,00 | € 292,50 |
| F11+F19 | F11+F19 | | € 238,00 | € 195,00 | € 230,00 | € 188,50 |

Matching stitches
Cuciture in tinta
For fabrics see page 306
Per i tessuti si veda a p. 306

PACKING / Imballo



TECHNICAL DETAILS / Dettagli tecnici

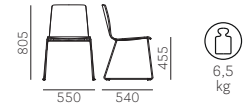

CATAS

Inga 5683



| SEAT Sedile | BACK Schienale | FRAME Telaio | WHITE/BLACK POWDER COATED Verniciato bianco/nero | CHROMED Cromato | VAT NOT INCLUDED Iva esclusa 22% |
|----------------|-------------------|-----------------|--|--------------------|--|
| C | C | Ø 16 | € 268,50 | € 268,50 | € 219,70 |
| G | G | | € 354,00 | € 354,00 | € 289,90 |
| H | H | | € 274,00 | € 274,00 | € 224,25 |

For fabrics see page 306
Per i tessuti si veda a p. 306

PACKING / Imballo



TECHNICAL DETAILS / Dettagli tecnici

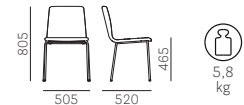

Inga 5689



| SEAT Sedile | BACK Schienale | FRAME Telaio | WHITE/BLACK POWDER COATED Verniciato bianco/nero | VAT NOT INCLUDED Iva esclusa 22% | CHROMED Cromato | VAT NOT INCLUDED Iva esclusa 22% |
|----------------|-------------------|-----------------|--|--|--------------------|--|
| C | C | Ø 10 | € 276,00 | € 226,20 | € 268,50 | € 219,70 |
| G | G | | € 362,00 | € 296,40 | € 354,00 | € 289,90 |
| H | H | | € 282,00 | € 230,75 | € 274,00 | € 224,25 |

For fabrics see page 306
Per i tessuti si veda a p. 306

PACKING / Imballo



TECHNICAL DETAILS / Dettagli tecnici

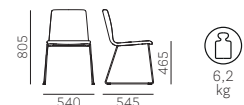

CATAS

Inga 5614



| SEAT Sedile | BACK Schienale | FRAME Telaio | WHITE/BLACK POWDER COATED Verniciato bianco/nero | CHROMED Cromato | VAT NOT INCLUDED Iva esclusa 22% |
|----------------|-------------------|-----------------|--|--------------------|--|
| RS-W-AN | RS-W-AN | Ø 16 | € 225,50 | € 225,50 | € 184,60 |

FINISHES / Finiture



PACKING / Imballo



TECHNICAL DETAILS / Dettagli tecnici



Inga 5664



| SEAT Sedile | BACK Schienale | FRAME Telaio | WHITE/BLACK POWDER COATED Verniciato bianco/nero | CHROMED Cromato | VAT NOT INCLUDED Iva esclusa 22% |
|----------------|-------------------|-----------------|--|--------------------|--|
| F01+F09 | F01+F09 | Ø 16 | € 396,50 | € 396,50 | € 325,00 |
| F11+F19 | F11+F19 | | € 270,00 | € 270,00 | € 221,00 |

Matching stitches
Cuciture in tinta
For fabrics see page 306
Per i tessuti si veda a p. 306

PACKING / Imballo



TECHNICAL DETAILS / Dettagli tecnici



Inga 5684



| SEAT Sedile | BACK Schienale | FRAME Telaio | WHITE/BLACK POWDER COATED Verniciato bianco/nero | CHROMED Cromato | VAT NOT INCLUDED Iva esclusa 22% |
|----------------|-------------------|-----------------|--|--------------------|--|
| C | C | Ø 16 | € 308,00 | € 308,00 | € 252,20 |
| G | G | | € 393,50 | € 393,50 | € 322,40 |
| H | H | | € 313,50 | € 313,50 | € 256,75 |

For fabrics see page 306
Per i tessuti si veda a p. 306

PACKING / Imballo



TECHNICAL DETAILS / Dettagli tecnici

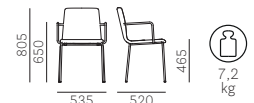

Inga 5685

Upholstered armrests
Braccioli imbottiti



| SEAT Sedile | BACK Schienale | FRAME Telaio | WHITE/BLACK POWDER COATED Verniciato bianco/nero | CHROMED Cromato | VAT NOT INCLUDED Iva esclusa 22% |
|----------------|-------------------|-----------------|--|--------------------|--|
| C | C | | € 450,50 | € 450,50 | € 369,20 |
| G | G | Ø 16 | € 536,50 | € 536,50 | € 439,40 |
| H | H | | € 456,00 | € 456,00 | € 373,75 |

For fabrics see page 306
Per i tessuti si veda a p. 306

PACKING / Imballo



TECHNICAL DETAILS / Dettagli tecnici

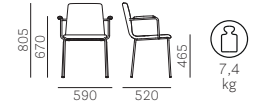

Inga 5616



| SEAT Sedile | BACK Schienale | FRAME Telaio | WHITE/BLACK POWDER COATED Verniciato bianco/nero | CHROMED Cromato | VAT NOT INCLUDED Iva esclusa 22% |
|----------------|-------------------|-----------------|--|--------------------|--|
| RS-W-AN | RS-W-AN | Ø 16 H 670 | € 233,50 | € 233,50 | € 191,10 |

FINISHES / Finiture



PACKING / Imballo



TECHNICAL DETAILS / Dettagli tecnici



Inga 5617



| SEAT Sedile | BACK Schienale | FRAME Telaio | WHITE/BLACK POWDER COATED Verniciato bianco/nero | CHROMED Cromato | VAT NOT INCLUDED Iva esclusa 22% |
|----------------|-------------------|-----------------|--|--------------------|--|
| RS-W-AN | RS-W-AN | Ø 16 H 770 | € 236,50 | € 236,50 | € 193,70 |

FINISHES / Finiture



PACKING / Imballo



TECHNICAL DETAILS / Dettagli tecnici



Inga 5686



| SEAT Sedile | BACK Schienale | FRAME Telaio | WHITE/BLACK POWDER COATED Verniciato bianco/nero | CHROMED Cromato | VAT NOT INCLUDED Iva esclusa 22% |
|----------------|-------------------|-----------------|--|--------------------|--|
| C | C | | € 316,00 | € 316,00 | € 258,70 |
| G | G | Ø 16 H 680 | € 401,50 | € 401,50 | € 328,90 |
| H | H | | € 321,50 | € 321,50 | € 263,25 |

For fabrics see page 306
Per i tessuti si veda a p. 306

PACKING / Imballo



TECHNICAL DETAILS / Dettagli tecnici



Inga 5687



| SEAT Sedile | BACK Schienale | FRAME Telaio | WHITE/BLACK POWDER COATED Verniciato bianco/nero | CHROMED Cromato | VAT NOT INCLUDED Iva esclusa 22% |
|----------------|-------------------|-----------------|--|--------------------|--|
| C | C | | € 319,00 | € 319,00 | € 261,30 |
| G | G | Ø 16 H 780 | € 404,50 | € 404,50 | € 331,50 |
| H | H | | € 324,50 | € 324,50 | € 265,85 |

For fabrics see page 306
Per i tessuti si veda a p. 306

PACKING / Imballo



TECHNICAL DETAILS / Dettagli tecnici



Inga 5681

LOUNGE



| SEAT Sedile | BACK Schienale | FRAME Telaio | WHITE/BLACK POWDER COATED Verniciato bianco/nero | CHROMED Cromato | VAT NOT INCLUDED Iva esclusa 22% |
|----------------|-------------------|-----------------|--|--------------------|--|
| C | C | | € 455,50 | € 455,50 | € 373,10 |
| G | G | Ø 16 | € 566,50 | € 566,50 | € 464,10 |
| H | H | | € 473,00 | € 473,00 | € 387,40 |

For fabrics see page 306
Per i tessuti si veda a p. 306

PACKING / Imballo



TECHNICAL DETAILS / Dettagli tecnici



Inga 5688

LOUNGE



| SEAT Sedile | BACK Schienale | FRAME Telaio | WHITE/BLACK POWDER COATED Verniciato bianco/nero | CHROMED Cromato | VAT NOT INCLUDED Iva esclusa 22% |
|----------------|-------------------|-----------------|--|--------------------|--|
| C | C | | € 471,50 | € 471,50 | € 386,10 |
| G | G | Ø 11 | € 582,50 | € 582,50 | € 477,10 |
| H | H | | € 488,50 | € 488,50 | € 400,40 |

For fabrics see page 306
Per i tessuti si veda a p. 306

PACKING / Imballo



TECHNICAL DETAILS / Dettagli tecnici

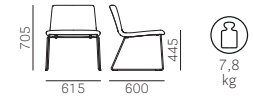

Intrigo 3715



| SEAT Sedile | BACK Schienale | FRAME Telaio | POWDER COATED Verniciato | VAT NOT INCLUDED Iva esclusa 22% |
|----------------|-------------------|-----------------|-----------------------------|--|
| METAL | METAL | METAL | € 333,50 | € 273,00 |

FINISHES / Finiture



PACKING / Imballo



TECHNICAL DETAILS / Dettagli tecnici

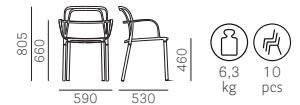

CATAS

Intrigo 3715.5

Seat cushion
Cuscino per sedile



| SEAT Sedile | FABRIC Tessuto | VAT NOT INCLUDED Iva esclusa 22% |
|----------------|-------------------|--|
| D31+D39 | € 116,00 | € 94,90 |

FINISHES / Finiture

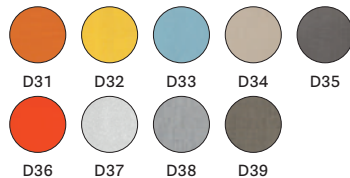

PACKING / Imballo



TECHNICAL DETAILS / Dettagli tecnici

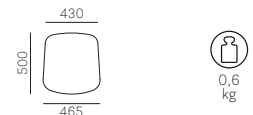

Intrigo 3715.20

Seat + back cushion
Cuscino per sedile e schienale



| SEAT Sedile | BACK Schienale | FABRIC Tessuto | VAT NOT INCLUDED Iva esclusa 22% |
|----------------|-------------------|-------------------|--|
| D31+D39 | D31+D39 | € 189,00 | € 154,70 |

FINISHES / Finiture

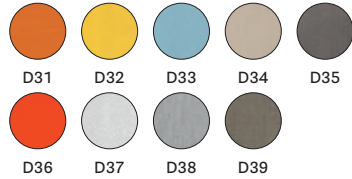

PACKING / Imballo



TECHNICAL DETAILS / Dettagli tecnici

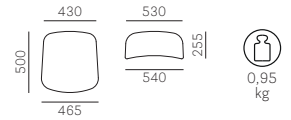

Island 795



| SEAT Sedile | BACK Schienale | FRAME Telaio | FABRIC Tessuto | VAT NOT INCLUDED Iva esclusa 22% |
|----------------|-------------------|-----------------|-------------------|--|
| B01+B02 | B01+B02 | Ø 900 | € 783,00 | € 641,55 |
| C90+C95 | C90+C95 | | € 783,00 | € 641,55 |

For fabrics see page 306
Per i tessuti si veda a p. 306

PACKING / Imballo



TECHNICAL DETAILS / Dettagli tecnici

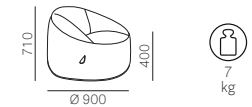

Island 796



| SEAT Sedile | FRAME Telaio | FABRIC Tessuto | VAT NOT INCLUDED Iva esclusa 22% |
|----------------|-----------------|-------------------|--|
| B01+B02 | Ø 650 | € 425,00 | € 348,14 |
| C90+C95 | | € 425,00 | € 348,14 |

For fabrics see page 306
Per i tessuti si veda a p. 306

PACKING / Imballo



TECHNICAL DETAILS / Dettagli tecnici

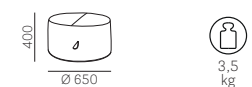

Island 797



| SEAT Sedile | FRAME Telaio | FABRIC Tessuto | VAT NOT INCLUDED Iva esclusa 22% |
|----------------|-----------------|-------------------|--|
| B01+B02 | Ø 900 | € 566,50 | € 464,10 |
| C90+C95 | | € 566,50 | € 464,10 |

For fabrics see page 306
Per i tessuti si veda a p. 306

PACKING / Imballo



TECHNICAL DETAILS / Dettagli tecnici

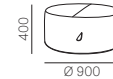

Jamaica 2910



| SEAT Sedile | BACK Schienale | FRAME Telaio | WHITE/BLACK POWDER COATED Verniciato bianco/nero | BLACK NICKEL Nichel nero | ANTIQU BRASS Ottone anticato | VAT NOT INCLUDED Iva esclusa 22% |
|----------------|-------------------|-----------------|--|-----------------------------|---------------------------------|--|
| FR-AN | FR-AN | FR-AN | € 435,00 | | | € 356,20 |
| | | | | € 514,00 | € 514,00 | € 421,20 |

FINISHES / Finiture



PACKING / Imballo



TECHNICAL DETAILS / Dettagli tecnici



CATAS



Jamaica 2911



| SEAT Sedile | BACK Schienale | FRAME Telaio | WHITE/BLACK POWDER COATED Verniciato bianco/nero | VAT NOT INCLUDED Iva esclusa 22% | BLACK NICKEL Nichel nero | ANTIQU BRASS Ottone anticato | VAT NOT INCLUDED Iva esclusa 22% |
|------------------------------------|------------------------------------|-----------------|--|--|-----------------------------|---------------------------------|--|
| C110+C122 | C110+C122 | FR-AN | € 595,00 | € 487,50 | € 674,50 | € 674,50 | € 552,50 |
| G59+G197 G160+G169 G180+G185 | G59+G197 G160+G169 G180+G185 | | € 691,50 | € 566,80 | € 771,00 | € 771,00 | € 631,80 |

For fabrics see page 306
Per i tessuti si veda a p. 306

FINISHES / Finiture



PACKING / Imballo



TECHNICAL DETAILS / Dettagli tecnici



CATAS



Jamaica 2915



| SEAT Sedile | BACK Schienale | FRAME Telaio | WHITE/BLACK POWDER COATED Verniciato bianco/nero | BLACK NICKEL Nichel nero | ANTIQUÉ BRASS Ottone anticato | VAT NOT INCLUDED Iva esclusa 22% |
|----------------|-------------------|-----------------|--|-----------------------------|----------------------------------|--|
| FR-AN | FR-AN | FR-AN | € 447,50 | | | € 366,60 |
| | | | | € 527,00 | € 527,00 | € 431,60 |

FINISHES / Finiture



PACKING / Imballo



TECHNICAL DETAILS / Dettagli tecnici

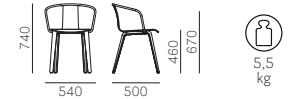

CATAS



Jamaica 2916



| SEAT Sedile | BACK Schienale | FRAME Telaio | WHITE/BLACK POWDER COATED Verniciato bianco/nero | VAT NOT INCLUDED Iva esclusa 22% | BLACK NICKEL Nichel nero | ANTIQUÉ BRASS Ottone anticato | VAT NOT INCLUDED Iva esclusa 22% |
|------------------------------------|------------------------------------|-----------------|--|--|-----------------------------|----------------------------------|--|
| C110+C122 | C110+C122 | FR-AN | € 607,50 | € 497,90 | € 687,00 | € 687,00 | € 562,90 |
| G59+G197 G160+G169 G180+G185 | G59+G197 G160+G169 G180+G185 | | € 704,50 | € 577,20 | € 783,50 | € 783,50 | € 642,20 |

For fabrics see page 306
Per i tessuti si veda a p. 306

FINISHES / Finiture

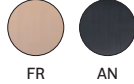

PACKING / Imballo



TECHNICAL DETAILS / Dettagli tecnici



CATAS



Jazz 3716



| SEAT Sedile | BACK Schienale | FRAME Telaio | WHITE/BLACK POWDER COATED Verniciato bianco/nero | VAT NOT INCLUDED Iva esclusa 22% | TITANIUM Titanio | VAT NOT INCLUDED Iva esclusa 22% |
|---------------------|---------------------|-----------------|--|--|---------------------|--|
| C83+C101 | C83+C101 | Ø 16 | € 615,50 | € 504,40 | € 739,50 | € 605,80 |
| E | E | | € 783,50 | € 642,20 | € 907,50 | € 743,60 |
| G | G | | € 783,50 | € 642,20 | € 907,50 | € 743,60 |
| H20+H108 H80+H90 | H20+H108 H80+H90 | | € 638,00 | € 522,60 | € 761,50 | € 624,00 |

For fabrics see page 306
Per i tessuti si veda a p. 306

PACKING / Imballo



TECHNICAL DETAILS / Dettagli tecnici

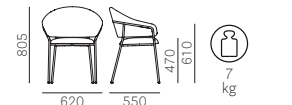

CATAS

Jazz 3717



| SEAT Sedile | BACK Schienale | FRAME Telaio | WHITE/BLACK POWDER COATED Verniciato bianco/nero | VAT NOT INCLUDED Iva esclusa 22% | TITANIUM Titanio | VAT NOT INCLUDED Iva esclusa 22% |
|---------------------|---------------------|---|--|--|---------------------|--|
| C83+C101 | C83+C101 | | € 628,50 | € 514,80 | € 798,00 | € 653,90 |
| E | E | Ø 16 H 660 | € 772,50 | € 633,10 | € 942,50 | € 772,20 |
| G | G | Excluding / Escluso G01+G09, G59+G197, G100+G102, G120+G122, G130+G133 | € 772,50 | € 633,10 | € 942,50 | € 772,20 |
| H20+H108 H80+H90 | H20+H108 H80+H90 | | € 647,50 | € 530,40 | € 817,00 | € 669,50 |

For fabrics see page 306
Per i tessuti si veda a p. 306

PACKING / Imballo



TECHNICAL DETAILS / Dettagli tecnici



Jazz 3718



| SEAT Sedile | BACK Schienale | FRAME Telaio | WHITE/BLACK POWDER COATED Verniciato bianco/nero | VAT NOT INCLUDED Iva esclusa 22% | TITANIUM Titanio | VAT NOT INCLUDED Iva esclusa 22% |
|---------------------|---------------------|---|--|--|---------------------|--|
| C83+C101 | C83+C101 | | € 631,50 | € 517,40 | € 801,00 | € 656,50 |
| E | E | Ø 16 H 760 | € 776,00 | € 635,70 | € 945,50 | € 774,80 |
| G | G | Excluding / Escluso G01+G09, G59+G197, G100+G102, G120+G122, G130+G133 | € 776,00 | € 635,70 | € 945,50 | € 774,80 |
| H20+H108 H80+H90 | H20+H108 H80+H90 | | € 650,50 | € 533,00 | € 820,00 | € 672,10 |

For fabrics see page 306
Per i tessuti si veda a p. 306

PACKING / Imballo



TECHNICAL DETAILS / Dettagli tecnici

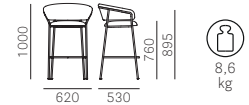

Jil 520



| SEAT Sedile | BACK Schienale | FRAME Telaio | OAK Rovere | VAT NOT INCLUDED Iva esclusa 22% |
|----------------|-------------------|-------------------|-----------------|--|
| G | G | | € 697,50 | € 571,35 |
| H | H | RS-W-N1- GC-BI | € 573,50 | € 469,95 |
| P | P | | € 743,50 | € 609,05 |

For fabrics see page 306
Per i tessuti si veda a p. 306

FINISHES / Finiture

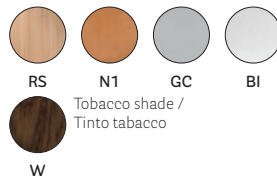

PACKING / Imballo



TECHNICAL DETAILS / Dettagli tecnici

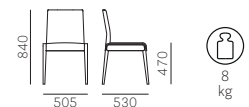

CATAS

Jil 525



| SEAT Sedile | BACK Schienale | FRAME Telaio | OAK Rovere | VAT NOT INCLUDED Iva esclusa 22% |
|----------------|-------------------|-------------------|-------------------|--|
| G | G | | € 1.023,00 | € 838,50 |
| H | H | RS-W-N1- GC-BI | € 809,00 | € 663,00 |
| P | P | | € 1.102,50 | € 903,50 |

For fabrics see page 306
Per i tessuti si veda a p. 306

FINISHES / Finiture



RS

N1

GC

BI

Tobacco shade /
Tinto tabacco

W

PACKING / Imballo



TECHNICAL DETAILS / Dettagli tecnici

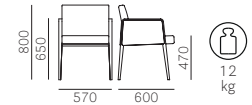

CATAS

Jil 526



| SEAT Sedile | BACK Schienale | FRAME Telaio | OAK Rovere | VAT NOT INCLUDED Iva esclusa 22% |
|----------------|-------------------|-----------------|-----------------|--|
| G | G | | € 927,50 | € 759,85 |
| H | H | H 780 | € 803,50 | € 658,45 |
| P | P | | € 973,50 | € 797,55 |

For fabrics see page 306
Per i tessuti si veda a p. 306

FINISHES / Finiture



RS

N1

GC

BI

Tobacco shade /
Tinto tabacco

W

PACKING / Imballo



TECHNICAL DETAILS / Dettagli tecnici

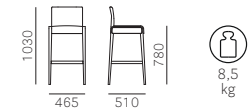

Jil 521

LOUNGE



| SEAT Sedile | BACK Schienale | FRAME Telaio | OAK Rovere | VAT NOT INCLUDED Iva esclusa 22% |
|----------------|-------------------|-------------------|-------------------|--|
| G | G | | € 1.432,50 | € 1.173,90 |
| H | H | RS-W-N1- GC-BI | € 1.132,50 | € 928,20 |
| P | P | | € 1.543,50 | € 1.264,90 |

For fabrics see page 306
Per i tessuti si veda a p. 306

FINISHES / Finiture



RS

N1

GC

BI

Tobacco shade /
Tinto tabacco

W

PACKING / Imballo



TECHNICAL DETAILS / Dettagli tecnici

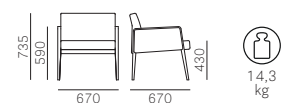

Joi 870



| SEAT Sedile | BACK Schienale | FRAME Telaio | ANODIZED ALUMINIUM Alluminio anodizzato satinato | VAT NOT INCLUDED Iva esclusa 22% |
|----------------|-------------------|-----------------|---|--|
| PPL | PPL | 27x27 | € 82,50 | € 67,60 |

PPL FINISHES / Finiture PPL



PACKING / Imballo



TECHNICAL DETAILS / Dettagli tecnici



CATAS

Joker 417



| SEAT Sedile | BACK Schienale | FRAME Telaio | SATINIZED Satinato | VAT NOT INCLUDED Iva esclusa 22% |
|----------------|-------------------|-----------------|-----------------------|--|
| H | H | 30x10 | € 1.689,50 | € 1.384,50 |
| P | P | | € 2.189,00 | € 1.794,00 |

For fabrics see page 306
Per i tessuti si veda a p. 306

PACKING / Imballo



TECHNICAL DETAILS / Dettagli tecnici

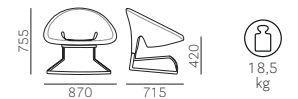

Koi-Booki 370



| SEAT Sedile | BACK Schienale | FRAME Telaio | POWDER COATED Verniciato | VAT NOT INCLUDED Iva esclusa 22% |
|----------------|-------------------|-----------------|-----------------------------|--|
| PPL | PPL | 22x22 | € 151,00* | € 123,50 |

FRAME/TELAIO*
Powder coated in the same colour of the shell / Verniciato in tinta con la scocca

PPL FINISHES / Finiture PPL



PACKING / Imballo



TECHNICAL DETAILS / Dettagli tecnici

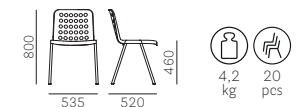

CATAS

Koi-Booki 370.3

Cushion only
Solo cuscino



| SEAT Sedile | BACK Schienale | FABRIC Tessuto | VAT NOT INCLUDED Iva esclusa 22% |
|----------------|-------------------|-------------------|--|
| GA | GA | € 114,50 | € 93,60 |

FINISH / Finitura



GA

PACKING / Imballo



MC 0,027

TECHNICAL DETAILS / Dettagli tecnici



Kuadra 1151



| SEAT Sedile | BACK Schienale | FRAME Telaio | CHROMED Cromato | VAT NOT INCLUDED Iva esclusa 22% |
|----------------|-------------------|-----------------|--------------------|--|
| TP | TP | Ø 16 | € 94,00 | € 76,70 |

TP FINISHES / Finiture TP



BI

AV

PACKING / Imballo



MC 0,34

TECHNICAL DETAILS / Dettagli tecnici



CATAS

Kuadra 1158



| SEAT Sedile | BACK Schienale | FRAME Telaio | CHROMED Cromato | VAT NOT INCLUDED Iva esclusa 22% |
|----------------|-------------------|-----------------|--------------------|--|
| TP | TP | Ø 10 | € 100,00 | € 81,90 |

TP FINISHES / Finiture TP



BI

AV

PACKING / Imballo



MC 0,28

TECHNICAL DETAILS / Dettagli tecnici

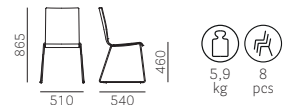

Kuadra 1271



| SEAT Sedile | BACK Schienale | FRAME Telaio | WHITE/BLACK POWDER COATED Verniciato bianco/nero | VAT NOT INCLUDED Iva esclusa 22% |
|----------------|-------------------|-----------------|--|--|
| PC | PC | 20x20 | € 154,00 | € 126,10 |

PC FINISHES / Finiture PC

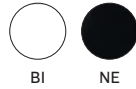

PACKING / Imballo



TECHNICAL DETAILS / Dettagli tecnici



CATAS

Kuadra 1271



| SEAT Sedile | BACK Schienale | FRAME Telaio | CHROMED Cromato | SATINIZED Satinato | VAT NOT INCLUDED Iva esclusa 22% |
|----------------|-------------------|-----------------|--------------------|-----------------------|--|
| PC | PC | 20x20 | € 203,50 | | € 166,40 |
| | | | | € 232,00 | € 189,80 |

PC FINISHES / Finiture PC



PACKING / Imballo



TECHNICAL DETAILS / Dettagli tecnici

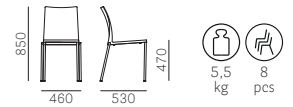

CATAS

Kuadra 1321



| SEAT Sedile | BACK Schienale | FRAME Telaio | CHROMED Cromato | SATINIZED Satinato | VAT NOT INCLUDED Iva esclusa 22% |
|----------------|-------------------|-----------------|--------------------|-----------------------|--|
| RS-W-AN | RS-W-AN | 20x20 | € 203,50 | | € 166,40 |
| | | | | € 239,50 | € 196,30 |

FINISHES / Finiture



PACKING / Imballo



TECHNICAL DETAILS / Dettagli tecnici



CATAS

Kuadra 1331



| SEAT Sedile | BACK Schienale | FRAME Telaio | CHROMED Cromato | VAT NOT INCLUDED Iva esclusa 22% |
|----------------|-------------------|-----------------|--------------------|--|
| RS-W-AN | RS-W-AN | Ø 16 | € 155,50 | € 127,40 |

FINISHES / Finiture



PACKING / Imballo



TECHNICAL DETAILS / Dettagli tecnici



Kuadra 1328



| SEAT Sedile | BACK Schienale | FRAME Telaio | CHROMED Cromato | VAT NOT INCLUDED Iva esclusa 22% |
|----------------|-------------------|-----------------|--------------------|--|
| RS-W-AN | RS-W-AN | Ø 10 | € 155,50 | € 127,40 |

FINISHES / Finiture



PACKING / Imballo



TECHNICAL DETAILS / Dettagli tecnici

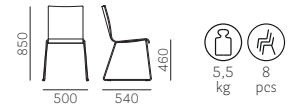

Kuadra 1281



| SEAT Sedile | BACK Schienale | FRAME Telaio | CHROMED Cromato | VAT NOT INCLUDED Iva esclusa 22% |
|----------------|-------------------|-----------------|--------------------|--|
| F01+F09 | F01+F09 | Ø 16 | € 325,50 | € 266,50 |
| F11+F19 | F11+F19 | | € 198,50 | € 162,50 |

For fabrics see page 306
Per i tessuti si veda a p. 306

PACKING / Imballo



TECHNICAL DETAILS / Dettagli tecnici



Kuadra 1291



| SEAT Sedile | BACK Schienale | FRAME Telaio | CHROMED Cromato | VAT NOT INCLUDED Iva esclusa 22% | SATINIZED Satinato | VAT NOT INCLUDED Iva esclusa 22% |
|----------------|-------------------|-----------------|--------------------|--|-----------------------|--|
| F01+F09 | F01+F09 | 20x20 | € 377,50 | € 309,40 | € 414,00 | € 339,30 |
| F11+F19 | F11+F19 | | € 258,50 | € 211,64 | € 287,50 | € 235,30 |

For fabrics see page 306
Per i tessuti si veda a p. 306

PACKING / Imballo



TECHNICAL DETAILS / Dettagli tecnici

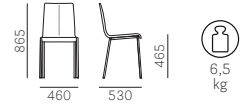

Kuadra 1298



| SEAT Sedile | BACK Schienale | FRAME Telaio | CHROMED Cromato | VAT NOT INCLUDED Iva esclusa 22% |
|----------------|-------------------|-----------------|--------------------|--|
| F01+F09 | F01+F09 | Ø 10 | € 325,50 | € 266,50 |
| F11+F19 | F11+F19 | | € 198,50 | € 162,50 |

For fabrics see page 306
Per i tessuti si veda a p. 306

PACKING / Imballo



TECHNICAL DETAILS / Dettagli tecnici

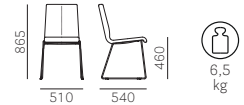

Kuadra 1102



| SEAT Sedile | BACK Schienale | FRAME Telaio | CHROMED Cromato | SATINIZED Satinato | VAT NOT INCLUDED Iva esclusa 22% |
|----------------|-------------------|-----------------|--------------------|-----------------------|--|
| TP | TP | 20x20 H 650 | € 202,50 | | € 165,75 |
| | | | | € 238,00 | € 195,00 |

TP FINISHES / Finiture TP



PACKING / Imballo



TECHNICAL DETAILS / Dettagli tecnici



Kuadra 1106



| SEAT Sedile | BACK Schienale | FRAME Telaio | CHROMED Cromato | SATINIZED Satinato | VAT NOT INCLUDED Iva esclusa 22% |
|----------------|-------------------|-----------------|--------------------|-----------------------|--|
| TP | TP | 20x20 H 800 | € 233,50 | € 266,00 | € 191,10 € 217,75 |

TP FINISHES / Finiture TP



PACKING / Imballo



TECHNICAL DETAILS / Dettagli tecnici

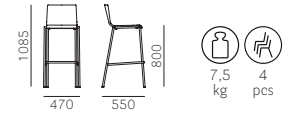

Kuadra 1112



| SEAT Sedile | BACK Schienale | FRAME Telaio | CHROMED Cromato | VAT NOT INCLUDED Iva esclusa 22% |
|----------------|-------------------|-----------------|--------------------|--|
| TP | TP | Ø 16 H 670 | € 136,50 | € 111,80 |

TP FINISHES / Finiture TP



PACKING / Imballo



TECHNICAL DETAILS / Dettagli tecnici



Kuadra 1116



| SEAT Sedile | BACK Schienale | FRAME Telaio | CHROMED Cromato | VAT NOT INCLUDED Iva esclusa 22% |
|----------------|-------------------|-----------------|--------------------|--|
| TP | TP | Ø 16 H 770 | € 140,00 | € 114,40 |

TP FINISHES / Finiture TP



PACKING / Imballo



TECHNICAL DETAILS / Dettagli tecnici



CATAS

Kuadra 1172



| SEAT Sedile | BACK Schienale | FRAME Telaio | CHROMED Cromato | SATINIZED Satinato | VAT NOT INCLUDED Iva esclusa 22% |
|----------------|-------------------|-----------------|--------------------|-----------------------|--|
| ME | ME | 20x20 H 660 | € 320,50 | € 373,00 | € 262,60 € 305,50 |

ME FINISHES / Finiture ME



PACKING / Imballo



TECHNICAL DETAILS / Dettagli tecnici



Kuadra 1176



| SEAT Sedile | BACK Schienale | FRAME Telaio | CHROMED Cromato | SATINIZED Satinato | VAT NOT INCLUDED Iva esclusa 22% |
|----------------|-------------------|-----------------|--------------------|-----------------------|--|
| ME | ME | 20x20 H 790 | € 353,00 | € 392,00 | € 289,25 € 321,10 |

ME FINISHES / Finiture ME



PACKING / Imballo



TECHNICAL DETAILS / Dettagli tecnici

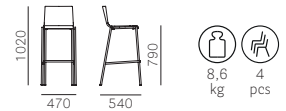

Kuadra 4427/F



| SEAT Sedile | BACK Schienale | FRAME Telaio | SATINIZED Satinato | VAT NOT INCLUDED Iva esclusa 22% |
|----------------|-------------------|-----------------|-----------------------|--|
| F01+F09 | F01+F09 | 400x400 | € 588,50 | € 482,30 |
| F11+F19 | F11+F19 | | € 474,50 | € 388,70 |

For fabrics see page 306
Per i tessuti si veda a p. 306

PACKING / Imballo



TECHNICAL DETAILS / Dettagli tecnici

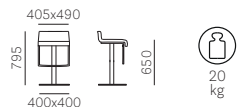

CATAS

Kuadra XL 2401



| SEAT Sedile | BACK Schienale | FRAME Telaio | POWDER COATED Verniciato | VAT NOT INCLUDED Iva esclusa 22% | SATINIZED Satinato | VAT NOT INCLUDED Iva esclusa 22% |
|----------------|-------------------|-----------------|-----------------------------|--|-----------------------|--|
| BI | BI | 20x20 | € 136,50* | € 111,80 | € 200,00 | € 163,80 |
| SA-RO | SA-RO | | € 159,00* | € 130,00 | € 222,50 | € 182,00 |

*Powder coated in the same colour of the shell
Verniciato in tinta con la scocca

TP FINISHES / Finiture TP



PACKING / Imballo



TECHNICAL DETAILS / Dettagli tecnici



CATAS

Kuadra XL 2403



| SEAT Sedile | BACK Schienale | FRAME Telaio | POWDER COATED Verniciato | CHROMED Cromato | VAT NOT INCLUDED Iva esclusa 22% |
|----------------|-------------------|-----------------|-----------------------------|--------------------|--|
| BI | BI | Ø 16 | € 102,00* | € 102,00 | € 83,20 |
| SA-RO | SA-RO | | € 124,00* | € 124,00 | € 101,40 |

*Powder coated in the same colour of the shell
Verniciato in tinta con la scocca

TP FINISHES / Finiture TP



PACKING / Imballo



TECHNICAL DETAILS / Dettagli tecnici



Kuadra XL 2411



| SEAT Sedile | BACK Schienale | FRAME Telaio | CHROMED Cromato | VAT NOT INCLUDED Iva esclusa 22% | SATINIZED Satinato | VAT NOT INCLUDED Iva esclusa 22% |
|----------------|-------------------|-----------------|--------------------|--|-----------------------|--|
| RS-W-AN | RS-W-AN | 20x20 | € 224,00 | € 183,30 | € 264,50 | € 216,45 |
| N-MP | N-MP | | € 319,00 | € 261,30 | € 359,50 | € 294,45 |

FINISHES / Finiture



PACKING / Imballo



TECHNICAL DETAILS / Dettagli tecnici



CATAS

Kuadra XL 2413



| SEAT Sedile | BACK Schienale | FRAME Telaio | CHROMED Cromato | VAT NOT INCLUDED Iva esclusa 22% |
|----------------|-------------------|-----------------|--------------------|--|
| RS-W-AN | RS-W-AN | Ø 16 | € 171,50 | € 140,40 |
| N-MP | N-MP | | € 266,50 | € 218,40 |

FINISHES / Finiture

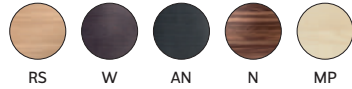

PACKING / Imballo



TECHNICAL DETAILS / Dettagli tecnici



Kuadra XL 2461



| SEAT Sedile | BACK Schienale | FRAME Telaio | SATINIZED Satinato | VAT NOT INCLUDED Iva esclusa 22% |
|----------------|-------------------|-----------------|-----------------------|--|
| F01+F09 | F01+F09 | 20x20 | € 456,00 | € 373,75 |
| F11+F19 | F11+F19 | | € 316,50 | € 259,35 |

For fabrics see page 306
Per i tessuti si veda a p. 306

PACKING / Imballo



TECHNICAL DETAILS / Dettagli tecnici

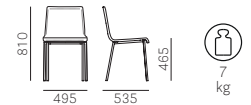

Kuadra XL 2463



| SEAT Sedile | BACK Schienale | FRAME Telaio | CHROMED Cromato | VAT NOT INCLUDED Iva esclusa 22% |
|----------------|-------------------|-----------------|--------------------|--|
| F01+F09 | F01+F09 | Ø 16 | € 358,00 | € 293,15 |
| F11+F19 | F11+F19 | | € 218,50 | € 178,75 |

For fabrics see page 306
Per i tessuti si veda a p. 306

PACKING / Imballo



TECHNICAL DETAILS / Dettagli tecnici



Kuadra XL 2491



| SEAT Sedile | BACK Schienale | FRAME Telaio | SATINIZED Satinato | VAT NOT INCLUDED Iva esclusa 22% |
|---------------------|---------------------|-----------------|-----------------------|--|
| H20+H108 H80+H90 | H20+H108 H80+H90 | 20x20 | € 453,00 | € 371,15 |

For fabrics see page 306
Per i tessuti si veda a p. 306

PACKING / Imballo



TECHNICAL DETAILS / Dettagli tecnici

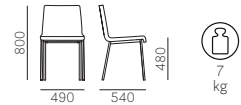

Kuadra XL 2402



| SEAT Sedile | BACK Schienale | FRAME Telaio | POWDER COATED Verniciato | VAT NOT INCLUDED Iva esclusa 22% | SATINIZED Satinato | VAT NOT INCLUDED Iva esclusa 22% |
|----------------|-------------------|-----------------|-----------------------------|--|-----------------------|--|
| BI | BI | 20x20 | € 175,50* | € 143,65 | € 254,00 | € 208,00 |
| SA-RO | SA-RO | | € 197,50* | € 161,85 | € 276,00 | € 226,20 |

*Powder coated in the same colour of the shell
Verniciato in tinta con la scocca

TP FINISHES / Finiture TP



PACKING / Imballo



TECHNICAL DETAILS / Dettagli tecnici

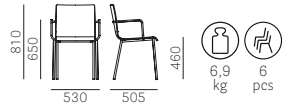

Kuadra XL 2404



| SEAT Sedile | BACK Schienale | FRAME Telaio | POWDER COATED Verniciato | CHROMED Cromato | VAT NOT INCLUDED Iva esclusa 22% |
|----------------|-------------------|-----------------|-----------------------------|--------------------|--|
| BI | BI | Ø 16 | € 149,50* | € 149,50 | € 122,20 |
| SA-RO | SA-RO | | € 159,00* | € 159,00 | € 130,00 |

*Powder coated in the same colour of the shell
Verniciato in tinta con la scocca

TP FINISHES / Finiture TP



PACKING / Imballo



TECHNICAL DETAILS / Dettagli tecnici



Kuadra XL 2462



| SEAT Sedile | BACK Schienale | FRAME Telaio | SATINIZED Satinato | VAT NOT INCLUDED Iva esclusa 22% |
|----------------|-------------------|-----------------|-----------------------|--|
| F01+F09 | F01+F09 | 20x20 | € 481,00 | € 393,90 |
| F11+F19 | F11+F19 | | € 366,50 | € 300,30 |

For fabrics see page 306
Per i tessuti si veda a p. 306

PACKING / Imballo



TECHNICAL DETAILS / Dettagli tecnici

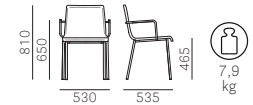

Kuadra XL 2464



| SEAT Sedile | BACK Schienale | FRAME Telaio | CHROMED Cromato | VAT NOT INCLUDED Iva esclusa 22% |
|----------------|-------------------|-----------------|--------------------|--|
| F01+F09 | F01+F09 | Ø 16 | € 401,50 | € 328,90 |
| F11+F19 | F11+F19 | | € 262,00 | € 214,50 |

For fabrics see page 306
Per i tessuti si veda a p. 306

PACKING / Imballo



TECHNICAL DETAILS / Dettagli tecnici

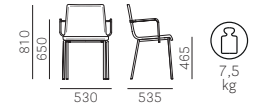

Kuadra XL 2482



| SEAT Sedile | BACK Schienale | FRAME Telaio | SATINIZED Satinato | VAT NOT INCLUDED Iva esclusa 22% |
|----------------|-------------------|-----------------|-----------------------|--|
| H | H | 20x20 | € 454,00 | € 371,80 |

For fabrics see page 306
Per i tessuti si veda a p. 306

PACKING / Imballo



TECHNICAL DETAILS / Dettagli tecnici

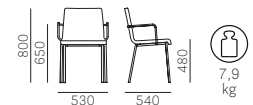

Laja 883

WOOD



| SEAT Sedile | BACK Schienale | FRAME Telaio | ASH Frassino | VAT NOT INCLUDED Iva esclusa 22% |
|----------------|-------------------|-----------------|-----------------|--|
| C | C | FR-N1-AN | € 693,50 | € 568,10 |
| G | G | | € 838,50 | € 687,05 |
| H | H | | € 701,50 | € 574,60 |

For fabrics see page 306
Per i tessuti si veda a p. 306

FINISHES / Finiture



FR

N1

AN

Upcharge for double-colour upholstery (inner/outer) **€ 32,00** (€ 26,00 vat not included)
Supplemento tappezzeria bicolore (fronte/retro) **€ 32,00** (€ 26,00 iva esclusa)

PACKING / Imballo



TECHNICAL DETAILS / Dettagli tecnici

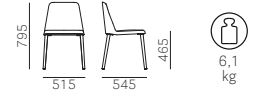

BS 5852:2006 (Clause 11 Crib 5)



Laja 880



| SEAT Sedile | BACK Schienale | WHITE/BLACK POWDER COATED Verniciato bianco/nero | VAT NOT INCLUDED Iva esclusa 22% | POLISHED ALUMINIUM Alluminio lucidato | VAT NOT INCLUDED Iva esclusa 22% |
|----------------|-------------------|--|--|--|--|
| C | C | € 677,50 | € 555,10 | € 709,00 | € 581,10 |
| G | G | € 822,50 | € 674,05 | € 854,50 | € 700,05 |
| H | H | € 685,50 | € 561,60 | € 717,00 | € 587,60 |

For fabrics see page 306
Per i tessuti si veda a p. 306

Upcharge for double-colour upholstery (inner/outer) **€ 32,00** (€ 26,00 vat not included)
Supplemento tappezzeria bicolore (fronte/retro) **€ 32,00** (€ 26,00 iva esclusa)

PACKING / Imballo



TECHNICAL DETAILS / Dettagli tecnici



CATAS

BS 5852:2006 (Clause 11 Crib 5)

Laja 881



| SEAT Sedile | BACK Schienale | FRAME Telaio | WHITE/BLACK POWDER COATED Verniciato bianco/nero | CHROMED Cromato | VAT NOT INCLUDED Iva esclusa 22% |
|----------------|-------------------|-----------------|--|--------------------|--|
| C | C | Ø 12 | € 698,00 | € 698,00 | € 572,00 |
| G | G | | € 891,50 | € 891,50 | € 730,60 |
| H | H | | € 709,00 | € 709,00 | € 581,10 |

For fabrics see page 306
Per i tessuti si veda a p. 306

Upcharge for double-colour upholstery (inner/outer) **€ 32,00** (€ 26,00 vat not included)
Supplemento tappezzeria bicolore (fronte/retro) **€ 32,00** (€ 26,00 iva esclusa)

PACKING / Imballo



TECHNICAL DETAILS / Dettagli tecnici

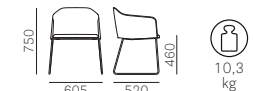

BS 5852:2006 (Clause 11 Crib 5)

Laja 882

CANTILEVER



| SEAT Sedile | BACK Schienale | FRAME Telaio | WHITE/BLACK POWDER COATED Verniciato bianco/nero | VAT NOT INCLUDED Iva esclusa 22% | CHROMED Cromato | VAT NOT INCLUDED Iva esclusa 22% |
|----------------|-------------------|-----------------|--|--|--------------------|--|
| C | C | | € 753,00 | € 616,85 | € 784,50 | € 642,85 |
| G | G | Ø 25 | € 947,00 | € 776,10 | € 979,00 | € 802,10 |
| H | H | | € 764,50 | € 626,60 | € 796,50 | € 652,60 |

For fabrics see page 306
Per i tessuti si veda a p. 306

Upcharge for double-colour upholstery (inner/outer) **€ 32,00** (€ 26,00 vat not included)
Supplemento tappezzeria bicolore (fronte/retro) **€ 32,00** (€ 26,00 iva esclusa)

PACKING / Imballo



TECHNICAL DETAILS / Dettagli tecnici

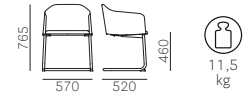

CATAS

BS 5852:2006 (Clause 11 Crib 5)

Laja 884

WOOD



| SEAT Sedile | BACK Schienale | FRAME Telaio | ASH Frassino | VAT NOT INCLUDED Iva esclusa 22% |
|----------------|-------------------|-----------------|-----------------|--|
| C | C | | € 768,50 | € 629,85 |
| G | G | FR-N1-AN | € 963,00 | € 789,10 |
| H | H | | € 780,50 | € 639,60 |

For fabrics see page 306
Per i tessuti si veda a p. 306

Upcharge for double-colour upholstery (inner/outer) **€ 32,00** (€ 26,00 vat not included)
Supplemento tappezzeria bicolore (fronte/retro) **€ 32,00** (€ 26,00 iva esclusa)

PACKING / Imballo



TECHNICAL DETAILS / Dettagli tecnici

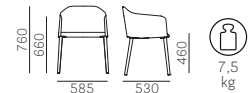

FINISHES / Finiture



FR N1 AN

CATAS

BS 5852:2006 (Clause 11 Crib 5)



Laja 885



| SEAT Sedile | BACK Schienale | WHITE/BLACK POWDER COATED Verniciato bianco/nero | VAT NOT INCLUDED Iva esclusa 22% | POLISHED ALUMINIUM Alluminio lucidato | VAT NOT INCLUDED Iva esclusa 22% |
|----------------|-------------------|--|--|--|--|
| C | C | € 753,00 | € 616,85 | € 784,50 | € 642,85 |
| G | G | € 947,00 | € 776,10 | € 979,00 | € 802,10 |
| H | H | € 764,50 | € 626,60 | € 796,50 | € 652,60 |

For fabrics see page 306
Per i tessuti si veda a p. 306

Upcharge for double-colour upholstery (inner/outer) **€ 32,00** (€ 26,00 vat not included)
Supplemento tappezzeria bicolore (fronte/retro) **€ 32,00** (€ 26,00 iva esclusa)

PACKING / Imballo



TECHNICAL DETAILS / Dettagli tecnici



CATAS

BS 5852:2006 (Clause 11 Crib 5)

Laja 886



| SEAT Sedile | BACK Schienale | FRAME Telaio | WHITE/BLACK POWDER COATED Verniciato bianco/nero | VAT NOT INCLUDED Iva esclusa 22% | POLISHED ALUMINIUM Alluminio lucidato | VAT NOT INCLUDED Iva esclusa 22% |
|----------------|-------------------|-----------------|--|--|---|--|
| C | C | | € 879,50 | € 720,85 | € 927,50 | € 759,85 |
| G | G | Ø 680 | € 1.074,00 | € 880,10 | € 1.121,50 | € 919,10 |
| H | H | | € 891,50 | € 730,60 | € 939,00 | € 769,60 |

For fabrics see page 306
Per i tessuti si veda a p. 306

Upcharge for double-colour upholstery (inner/outer) **€ 32,00** (€ 26,00 vat not included)
Supplemento tappezzeria bicolore (fronte/retro) **€ 32,00** (€ 26,00 iva esclusa)

PACKING / Imballo

TECHNICAL DETAILS / Dettagli tecnici

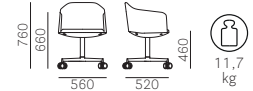

CATAS

BS 5852:2006 (Clause 11 Crib 5)

Laja 887



| SEAT Sedile | BACK Schienale | FRAME Telaio | WHITE/BLACK POWDER COATED Verniciato bianco/nero | VAT NOT INCLUDED Iva esclusa 22% | POLISHED ALUMINIUM Alluminio lucidato | VAT NOT INCLUDED Iva esclusa 22% |
|----------------|-------------------|-----------------|--|--|---|--|
| C | C | | € 911,50 | € 746,85 | € 959,00 | € 785,85 |
| G | G | Ø 680 | € 1.105,50 | € 906,10 | € 1.153,50 | € 945,10 |
| H | H | | € 923,50 | € 756,60 | € 971,00 | € 795,60 |

For fabrics see page 306
Per i tessuti si veda a p. 306

Upcharge for double-colour upholstery (inner/outer) **€ 32,00** (€ 26,00 vat not included)
Supplemento tappezzeria bicolore (fronte/retro) **€ 32,00** (€ 26,00 iva esclusa)

PACKING / Imballo

TECHNICAL DETAILS / Dettagli tecnici



BS 5852:2006 (Clause 11 Crib 5)

Laja 889G

WINGS



| SEAT Sedile | BACK Schienale | FRAME Telaio | FABRIC Tessuto | VAT NOT INCLUDED Iva esclusa 22% |
|----------------|-------------------|-----------------|-------------------|--|
| C | C | C | € 1.194,50 | € 978,90 |
| G | G | G | € 1.396,00 | € 1.144,00 |
| H | H | H | € 1.210,50 | € 991,90 |

For fabrics see page 306
Per i tessuti si veda a p. 306

Upcharge for double-colour upholstery (inner/outer) **€ 32,00** (€ 26,00 vat not included)
Supplemento tappezzeria bicolore (fronte/retro) **€ 32,00** (€ 26,00 iva esclusa)

PACKING / Imballo

TECHNICAL DETAILS / Dettagli tecnici

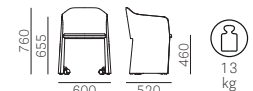

CATAS

BS 5852:2006 (Clause 11 Crib 5)

Laja 889F

WINGS



| SEAT Sedile | BACK Schienale | FRAME Telaio | FABRIC Tessuto | VAT NOT INCLUDED Iva esclusa 22% |
|----------------|-------------------|-----------------|-------------------|--|
| C | C | C | € 1.147,00 | € 939,90 |
| G | G | G | € 1.316,50 | € 1.079,00 |
| H | H | H | € 1.163,00 | € 952,90 |

For fabrics see page 306
Per i tessuti si veda a p. 306

Upcharge for double-colour upholstery (inner/outer) **€ 32,00** (€ 26,00 vat not included)
Supplemento tappezzeria bicolore (fronte/retro) **€ 32,00** (€ 26,00 iva esclusa)

PACKING / Imballo



TECHNICAL DETAILS / Dettagli tecnici

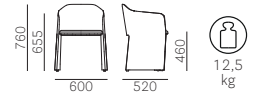

CATAS

BS 5852:2006 (Clause 11 Crib 5)

Leila 682



| SEAT Sedile | BACK Schienale | FRAME Telaio | SATINIZED Satinato | VAT NOT INCLUDED Iva esclusa 22% |
|----------------|-------------------|-----------------|-----------------------|--|
| H | H | Ø 16 | € 714,00 | € 585,00 |

For fabrics see page 306
Per i tessuti si veda a p. 306

PACKING / Imballo



TECHNICAL DETAILS / Dettagli tecnici

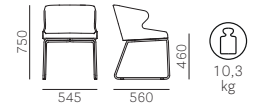

Log 365



| SEAT Sedile | BACK Schienale | FRAME Telaio | FABRIC Tessuto | VAT NOT INCLUDED Iva esclusa 22% |
|---------------------|---------------------|---------------------|-------------------|--|
| C | C | C | € 766,50 | € 627,90 |
| E | E | E | € 912,00 | € 747,50 |
| G | G | G | € 912,00 | € 747,50 |
| H20+H108 H80+H90 | H20+H108 H80+H90 | H20+H108 H80+H90 | € 777,50 | € 637,00 |

For fabrics see page 306
Per i tessuti si veda a p. 306

PACKING / Imballo



TECHNICAL DETAILS / Dettagli tecnici



CATAS

BS 5852:2006 (Clause 11 Crib 5)

Log 366

LOUNGE



| SEAT Sedile | BACK Schienale | FRAME Telaio | FABRIC Tessuto | VAT NOT INCLUDED Iva esclusa 22% |
|---------------------|---------------------|---------------------|-------------------|--|
| C | C | C | € 1.120,00 | € 917,80 |
| E | E | E | € 1.443,50 | € 1.183,00 |
| G | G | G | € 1.443,50 | € 1.183,00 |
| H20+H108 H80+H90 | H20+H108 H80+H90 | H20+H108 H80+H90 | € 1.140,50 | € 934,70 |

For fabrics see page 306
Per i tessuti si veda a p. 306

PACKING / Imballo



TECHNICAL DETAILS / Dettagli tecnici

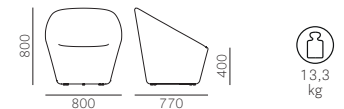

BS 5852:2006 (Clause 11 Crib 5)

Log 367

POUF



| SEAT Sedile | FRAME Telaio | FABRIC Tessuto | VAT NOT INCLUDED Iva esclusa 22% |
|---------------------|---------------------|-------------------|--|
| C | C | € 588,50 | € 482,30 |
| E | E | € 744,00 | € 609,70 |
| G | G | € 744,00 | € 609,70 |
| H20+H108 H80+H90 | H20+H108 H80+H90 | € 598,00 | € 490,10 |

For fabrics see page 306
Per i tessuti si veda a p. 306

PACKING / Imballo



TECHNICAL DETAILS / Dettagli tecnici



BS 5852:2006 (Clause 11 Crib 5)

Log 368

SOFA



| SEAT Sedile | BACK Schienale | FRAME Telaio | FABRIC Tessuto | VAT NOT INCLUDED Iva esclusa 22% |
|---------------------|---------------------|---------------------|-------------------|--|
| C | C | C | € 1.862,00 | € 1.526,20 |
| E | E | E | € 2.343,00 | € 1.920,10 |
| G | G | G | € 2.343,00 | € 1.920,10 |
| H20+H108 H80+H90 | H20+H108 H80+H90 | H20+H108 H80+H90 | € 1.929,00 | € 1.580,80 |

For fabrics see page 306
Per i tessuti si veda a p. 306

PACKING / Imballo



TECHNICAL DETAILS / Dettagli tecnici



BS 5852:2006 (Clause 11 Crib 5)

Malmö 390



| SEAT Sedile | BACK Schienale | FRAME Telaio | ASH Frassino | VAT NOT INCLUDED Iva esclusa 22% |
|--------------------|--------------------|--------------------|-----------------|--|
| FR-N1-AN- GC-BI | FR-N1-AN- GC-BI | FR-N1-AN- GC-BI | € 341,00 | € 279,50 |

FINISHES / Finiture



PACKING / Imballo



TECHNICAL DETAILS / Dettagli tecnici



CATAS



Malmö 392



| SEAT Sedile | BACK Schienale | FRAME Telaio | ASH Frassino | VAT NOT INCLUDED Iva esclusa 22% |
|----------------|-------------------|--------------------|-----------------|--|
| F01+F09 | F01+F09 | FR-N1-AN- GC-BI | € 504,50 | € 413,40 |

Matching stitches
Cuciture in tinta

For fabrics see page 306
Per i tessuti si veda a p. 306

FINISHES / Finiture

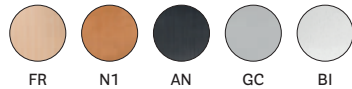

PACKING / Imballo



TECHNICAL DETAILS / Dettagli tecnici



CATAS



Malmö 391



| SEAT Sedile | BACK Schienale | FRAME Telaio | ASH Frassino | VAT NOT INCLUDED Iva esclusa 22% |
|----------------|-------------------|--------------------|-----------------|--|
| G | G | | € 575,00 | € 471,25 |
| H | H | FR-N1-AN- GC-BI | € 492,50 | € 403,65 |
| P | P | | € 672,00 | € 550,55 |

For fabrics see page 306
Per i tessuti si veda a p. 306

FINISHES / Finiture



PACKING / Imballo



TECHNICAL DETAILS / Dettagli tecnici



CATAS

BS 5852:2006 (Clause 11 Crib 5)



Malmö 395



| SEAT Sedile | BACK Schienale | FRAME Telaio | ASH Frassino | VAT NOT INCLUDED Iva esclusa 22% |
|--------------------|--------------------|--------------------|-----------------|--|
| FR-N1-AN- GC-BI | FR-N1-AN- GC-BI | FR-N1-AN- GC-BI | € 396,50 | € 325,00 |

FINISHES / Finiture



PACKING / Imballo



TECHNICAL DETAILS / Dettagli tecnici

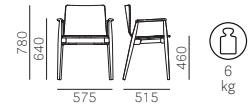

Malmö 397



| SEAT Sedile | BACK Schienale | FRAME Telaio | ASH Frassino | VAT NOT INCLUDED Iva esclusa 22% |
|----------------|-------------------|--------------------|-----------------|--|
| F01+F09 | F01+F09 | FR-N1-AN- GC-BI | € 573,00 | € 469,30 |

Matching stitches
Cuciture in tinta

For fabrics see page 306
Per i tessuti si veda a p. 306

FINISHES / Finiture



PACKING / Imballo



TECHNICAL DETAILS / Dettagli tecnici

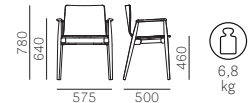

Malmö 396



| SEAT Sedile | BACK Schienale | FRAME Telaio | ASH Frassino | VAT NOT INCLUDED Iva esclusa 22% |
|----------------|-------------------|--------------------|-----------------|--|
| G | G | | € 643,50 | € 527,15 |
| H | H | FR-N1-AN- GC-BI | € 561,00 | € 459,55 |
| P | P | | € 740,00 | € 606,45 |

For fabrics see page 306
Per i tessuti si veda a p. 306

FINISHES / Finiture



PACKING / Imballo



TECHNICAL DETAILS / Dettagli tecnici



BS 5852:2006 (Clause 11 Crib 5)



Malmö 232



| SEAT Sedile | BACK Schienale | FRAME Telaio | ASH Frassino | VAT NOT INCLUDED Iva esclusa 22% |
|--------------------|--------------------|-----------------|----------------------------------|--|
| | | | BRUSHED S/STEEL Inox satinato | |
| FR-N1-AN- GC-BI | FR-N1-AN- GC-BI | H 650 | € 468,00 | € 383,50 |

FINISHES / Finiture



PACKING / Imballo



TECHNICAL DETAILS / Dettagli tecnici



Malmö 236



| SEAT Sedile | BACK Schienale | FRAME Telaio | ASH Frassino | VAT NOT INCLUDED Iva esclusa 22% |
|--------------------|--------------------|-----------------|----------------------------------|--|
| | | | BRUSHED S/STEEL Inox satinato | |
| FR-N1-AN- GC-BI | FR-N1-AN- GC-BI | H 750 | € 484,00 | € 396,50 |

FINISHES / Finiture



PACKING / Imballo



TECHNICAL DETAILS / Dettagli tecnici



Malmö 252



| SEAT Sedile | BACK Schienale | FRAME Telaio | ASH Frassino | VAT NOT INCLUDED Iva esclusa 22% |
|----------------|-------------------|-----------------|----------------------------------|--|
| | | | BRUSHED S/STEEL Inox satinato | |
| F01+F09 | F01+F09 | H 655 | € 660,00 | € 540,80 |

Matching stitches

Cuciture in tinta

For fabrics see page 306

Per i tessuti si veda a p. 306

FINISHES / Finiture



PACKING / Imballo



TECHNICAL DETAILS / Dettagli tecnici



Malmö 256



| SEAT Sedile | BACK Schienale | FRAME Telaio | ASH Frassino | VAT NOT INCLUDED Iva esclusa 22% |
|----------------|-------------------|-----------------|----------------------------------|--|
| | | | BRUSHED S/STEEL Inox satinato | |
| F01+F09 | F01+F09 | H 755 | € 676,00 | € 553,80 |

Matching stitches
Cuciture in tinta
For fabrics see page 306
Per i tessuti si veda a p. 306

FINISHES / Finiture



PACKING / Imballo



TECHNICAL DETAILS / Dettagli tecnici



Malmö 242



| SEAT Sedile | BACK Schienale | FRAME Telaio | ASH Frassino | VAT NOT INCLUDED Iva esclusa 22% |
|----------------|-------------------|-----------------|----------------------------------|--|
| | | | BRUSHED S/STEEL Inox satinato | |
| G | G | | € 730,50 | € 598,65 |
| H | H | H 655 | € 648,00 | € 531,05 |
| P | P | | € 827,50 | € 677,95 |

For fabrics see page 306
Per i tessuti si veda a p. 306

FINISHES / Finiture



PACKING / Imballo



TECHNICAL DETAILS / Dettagli tecnici



BS 5852:2006 (Clause 11 Crib 5)



Malmö 246



| SEAT Sedile | BACK Schienale | FRAME Telaio | ASH Frassino | VAT NOT INCLUDED Iva esclusa 22% |
|----------------|-------------------|-----------------|----------------------------------|--|
| | | | BRUSHED S/STEEL Inox satinato | |
| G | G | | € 746,50 | € 611,65 |
| H | H | H 755 | € 664,00 | € 544,05 |
| P | P | | € 843,00 | € 690,95 |

For fabrics see page 306
Per i tessuti si veda a p. 306

FINISHES / Finiture



PACKING / Imballo



TECHNICAL DETAILS / Dettagli tecnici



BS 5852:2006 (Clause 11 Crib 5)



Malmö 295

LOUNGE



| SEAT Sedile | BACK Schienale | FRAME Telaio | ASH Frassino | VAT NOT INCLUDED Iva esclusa 22% |
|--------------------|--------------------|--------------------|-----------------|--|
| FR-N1-AN- GC-BI | FR-N1-AN- GC-BI | FR-N1-AN- GC-BI | € 490,50 | € 401,70 |

FINISHES / Finiture



PACKING / Imballo



TECHNICAL DETAILS / Dettagli tecnici

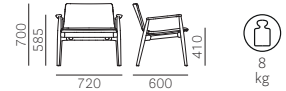

CATAS



Malmö 297

LOUNGE



| SEAT Sedile | BACK Schienale | FRAME Telaio | ASH Frassino | VAT NOT INCLUDED Iva esclusa 22% |
|----------------|-------------------|--------------------|-----------------|--|
| F01+F09 | F01+F09 | FR-N1-AN- GC-BI | € 714,00 | € 585,00 |

Matching stitches
Cuciture in tinta

For fabrics see page 306
Per i tessuti si veda a p. 306

FINISHES / Finiture

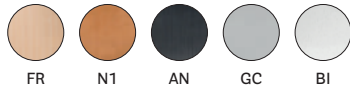

PACKING / Imballo



TECHNICAL DETAILS / Dettagli tecnici



CATAS



Malmö 296

LOUNGE



| SEAT Sedile | BACK Schienale | FRAME Telaio | ASH Frassino | VAT NOT INCLUDED Iva esclusa 22% |
|----------------|-------------------|--------------------|-----------------|--|
| G | G | | € 834,50 | € 683,80 |
| H | H | FR-N1-AN- GC-BI | € 736,00 | € 603,20 |
| P | P | | € 868,00 | € 711,10 |

For fabrics see page 306
Per i tessuti si veda a p. 306

FINISHES / Finiture



PACKING / Imballo



TECHNICAL DETAILS / Dettagli tecnici



CATAS

BS 5852:2006 (Clause 11 Crib 5)



Malmö 299

RELAX



| SEAT Sedile | BACK Schienale | FRAME Telaio | ASH Frassino | VAT NOT INCLUDED Iva esclusa 22% |
|--------------------|--------------------|--------------------|-----------------|--|
| FR-N1-AN- GC-BI | FR-N1-AN- GC-BI | FR-N1-AN- GC-BI | € 561,50 | € 460,20 |

FINISHES / Finiture



PACKING / Imballo



TECHNICAL DETAILS / Dettagli tecnici

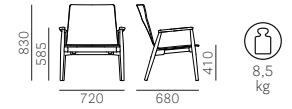

Malmö 298

RELAX



| SEAT Sedile | BACK Schienale | FRAME Telaio | ASH Frassino | VAT NOT INCLUDED Iva esclusa 22% |
|----------------|-------------------|--------------------|-------------------|--|
| C | C | | € 871,00 | € 713,70 |
| G | G | FR-N1-AN- GC-BI | € 1.044,00 | € 855,40 |
| H | H | | € 895,00 | € 733,20 |
| P | P | | € 1.185,00 | € 971,10 |

For fabrics see page 306
Per i tessuti si veda a p. 306

FINISHES / Finiture



PACKING / Imballo



TECHNICAL DETAILS / Dettagli tecnici

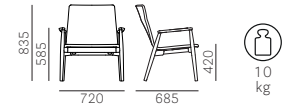

BS 5852:2006 (Clause 11 Crib 5)



Mies 415



| SEAT Sedile | BACK Schienale | FRAME Telaio | BRUSHED S/STEEL Inox satinato | VAT NOT INCLUDED Iva esclusa 22% |
|----------------|-------------------|-----------------|----------------------------------|--|
| H | H | 30x6 | € 1.622,50 | € 1.329,90 |
| P | P | | € 1.932,00 | € 1.583,40 |

For fabrics see page 306
Per i tessuti si veda a p. 306

PACKING / Imballo



TECHNICAL DETAILS / Dettagli tecnici

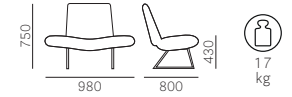

Modus

Linear
Lineare

MDL

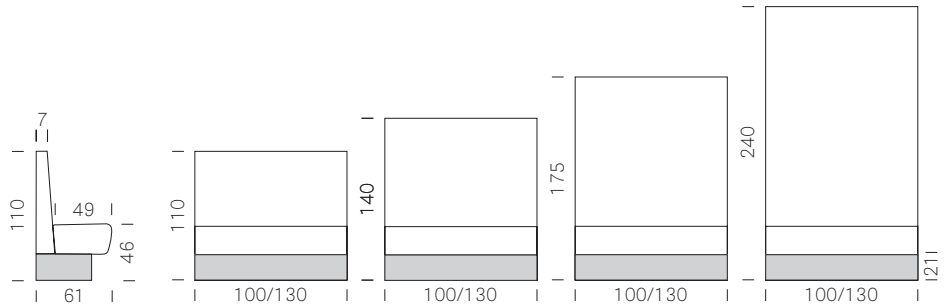

MDL_110 MDL_110_L100

| FABRIC Tessuto | SMOOTH Liscio | BUTTONS Bottoni | CAPITONÉ Capitoné | HORIZONTAL STITCHES Cuciture orizzontali | VERTICAL STITCHES Cuciture verticali |
|-------------------|---------------------------------|---------------------------------|---------------------------------|--|--|
| E; G | € 1.767,00 € 1.448,20 | € 1.799,00 € 1.474,20 | € 2.052,50 € 1.682,20 | € 1.814,50 € 1.487,20 | € 1.925,50 € 1.578,20 |
| H | € 1.513,50 € 1.240,20 | € 1.545,00 € 1.266,20 | € 1.799,00 € 1.474,20 | € 1.561,00 € 1.279,20 | € 1.672,00 € 1.370,20 |

MDL_140 MDL_140_L100

| FABRIC Tessuto | SMOOTH Liscio | BUTTONS Bottoni | CAPITONÉ Capitoné | HORIZONTAL STITCHES Cuciture orizzontali | VERTICAL STITCHES Cuciture verticali |
|-------------------|---------------------------------|---------------------------------|---------------------------------|--|--|
| E; G | € 2.084,50 € 1.708,20 | € 2.163,50 € 1.773,20 | € 2.592,00 € 2.124,20 | € 2.211,00 € 1.812,20 | € 2.243,00 € 1.838,20 |
| H | € 1.841,50 € 1.509,30 | € 1.921,00 € 1.574,30 | € 2.349,00 € 1.925,30 | € 1.968,50 € 1.613,30 | € 2.000,00 € 1.639,30 |

MDL_175 MDL_175_L100

| FABRIC Tessuto | SMOOTH Liscio | BUTTONS Bottoni | CAPITONÉ Capitoné | HORIZONTAL STITCHES Cuciture orizzontali |
|-------------------|---------------------------------|---------------------------------|---------------------------------|--|
| E; G | € 2.084,50 € 1.708,20 | € 2.163,50 € 1.773,20 | € 2.592,00 € 2.124,20 | € 2.211,00 € 1.812,20 |
| H | € 1.841,50 € 1.509,30 | € 1.921,00 € 1.574,30 | € 2.349,00 € 1.925,30 | € 1.968,50 € 1.613,30 |

MDL_240 MDL_240_L100

| FABRIC Tessuto | SMOOTH Liscio | BUTTONS Bottoni | HORIZONTAL STITCHES Cuciture orizzontali |
|-------------------|---------------------------------|---------------------------------|--|
| E; G | € 2.571,00 € 2.107,30 | € 2.682,00 € 2.198,30 | € 2.777,50 € 2.276,30 |
| H | € 2.244,50 € 1.839,50 | € 2.355,50 € 1.930,50 | € 2.450,50 € 2.008,50 |

Prices in bold are vat included (IVA 22%)
I prezzi in grassetto si intendono iva inclusa (22%)

For fabrics see page 306
Per i tessuti si veda a p. 306

BS 5852:2006 (Clause 11 Crib 5)

ART. MD4

Baseboard finishes available / Zoccolo disponibile nei colori



Surcharge COUPLE SIDEBBOARD L = 44 cm (item MD4/LAT_50) = **€ 105,00** (€ 85,80 vat not included)
Supplemento COPPIA ZOCCOLO LATERALE L = 44 cm (cod. MD4/LAT_50) = **€ 105,00** (€ 85,80 iva esclusa)

Dimensions of Modus units are expressed in centimeters
Le misure dei moduli Modus sono espresse in centimetri

Modus

Back to back unit
Bifacciale

MDB

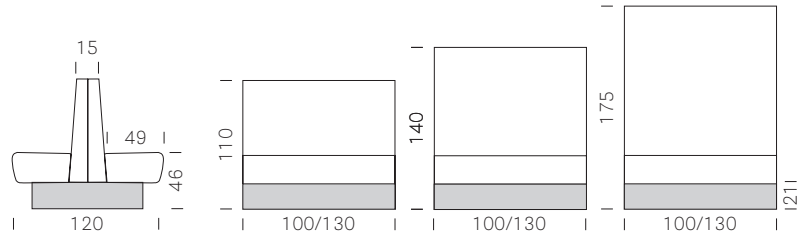
MDB_110
MDB_110_L100

| FABRIC Tessuto | SMOOTH Liscio | BUTTONS Bottoni | CAPITONÉ Capitoné | HORIZONTAL STITCHES Cuciture orizzontali | VERTICAL STITCHES Cuciture verticali |
|-------------------|--------------------------|--------------------------|--------------------------|--|--|
| E; G | € 3.470,50 € 2.844,40 | € 3.534,00 € 2.896,40 | € 4.041,50 € 3.312,40 | € 3.565,50 € 2.922,40 | € 3.787,50 € 3.104,40 |
| H | € 2.963,00 € 2.428,40 | € 3.026,50 € 2.480,40 | € 3.534,00 € 2.896,40 | € 3.058,00 € 2.506,40 | € 3.280,00 € 2.688,40 |

MDB_140
MDB_140_L100

| FABRIC Tessuto | SMOOTH Liscio | BUTTONS Bottoni | CAPITONÉ Capitoné | HORIZONTAL STITCHES Cuciture orizzontali | VERTICAL STITCHES Cuciture verticali |
|-------------------|--------------------------|--------------------------|--------------------------|--|--|
| E; G | € 4.089,00 € 3.351,40 | € 4.247,50 € 3.481,40 | € 5.104,00 € 4.183,40 | € 4.342,50 € 3.559,40 | € 4.406,00 € 3.611,40 |
| H | € 3.603,50 € 2.953,60 | € 3.762,00 € 3.083,60 | € 4.618,50 € 3.785,60 | € 3.857,50 € 3.161,60 | € 3.921,00 € 3.213,60 |

MDB_175
MDB_175_L100

| FABRIC Tessuto | SMOOTH Liscio | BUTTONS Bottoni | CAPITONÉ Capitoné | HORIZONTAL STITCHES Cuciture orizzontali |
|-------------------|--------------------------|--------------------------|--------------------------|--|
| E; G | € 4.089,00 € 3.351,40 | € 4.247,50 € 3.481,40 | € 5.104,00 € 4.183,40 | € 4.342,50 € 3.559,40 |
| H | € 3.603,50 € 2.953,60 | € 3.762,00 € 3.083,60 | € 4.618,50 € 3.785,60 | € 3.857,50 € 3.161,60 |

Prices in bold are vat included (IVA 22%)
I prezzi in grassetto si intendono iva inclusa (22%)

For fabrics see page 306
Per i tessuti si veda a p. 306

BS 5852:2006 (Clause 11 Crib 5)

ART. MD4

Baseboard finishes available / Zoccolo disponibile nei colori

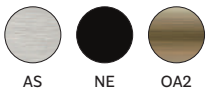

Surcharge COUPLE SIDEBOARD L = 85,5 cm (item MD4/LAT_100) = € 209,50 (€ 171,60 vat not included)
Supplemento COPPIA ZOCCOLO LATERALE L = 85,5 cm (cod. MD4/LAT_100) = € 209,50 (€ 171,60 iva esclusa)

Dimensions of Modus units are expressed in centimeters
Le misure dei moduli Modus sono espresse in centimetri

Modus

Corner unit
Angolare

MDA

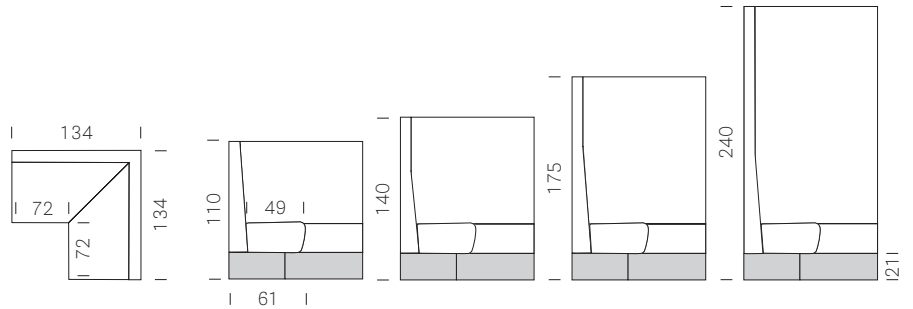

MDA_110

| FABRIC Tessuto | SMOOTH Liscio | BUTTONS Bottoni | CAPITONÉ Capitoné | HORIZONTAL STITCHES Cuciture orizzontali | VERTICAL STITCHES Cuciture verticali |
|-------------------|---------------------------------|---------------------------------|---------------------------------|--|--|
| E; G | € 3.534,00 € 2.896,40 | € 3.597,50 € 2.948,40 | € 4.105,00 € 3.364,40 | € 3.629,00 € 2.974,40 | € 3.851,00 € 3.156,40 |
| H | € 3.026,50 € 2.480,40 | € 3.090,00 € 2.532,40 | € 3.597,50 € 2.948,40 | € 3.121,50 € 2.558,40 | € 3.343,50 € 2.740,40 |

MDA_140

| FABRIC Tessuto | SMOOTH Liscio | BUTTONS Bottoni | CAPITONÉ Capitoné | HORIZONTAL STITCHES Cuciture orizzontali | VERTICAL STITCHES Cuciture verticali |
|-------------------|---------------------------------|---------------------------------|---------------------------------|--|--|
| E; G | € 4.168,50 € 3.416,40 | € 4.327,00 € 3.546,40 | € 5.183,50 € 4.248,40 | € 4.422,00 € 3.624,40 | € 4.485,50 € 3.676,40 |
| H | € 3.683,00 € 3.018,60 | € 3.841,50 € 3.148,60 | € 4.698,00 € 3.850,60 | € 3.936,50 € 3.226,60 | € 4.000,00 € 3.278,60 |

MDA_175

| FABRIC Tessuto | SMOOTH Liscio | BUTTONS Bottoni | CAPITONÉ Capitoné | HORIZONTAL STITCHES Cuciture orizzontali |
|-------------------|---------------------------------|---------------------------------|---------------------------------|--|
| E; G | € 4.168,50 € 3.416,40 | € 4.327,00 € 3.546,40 | € 5.183,50 € 4.248,40 | € 4.422,00 € 3.624,40 |
| H | € 3.683,00 € 3.018,60 | € 3.841,50 € 3.148,60 | € 4.698,00 € 3.850,60 | € 3.936,50 € 3.226,60 |

MDA_240

| FABRIC Tessuto | SMOOTH Liscio | BUTTONS Bottoni | HORIZONTAL STITCHES Cuciture orizzontali |
|-------------------|---------------------------------|---------------------------------|--|
| E; G | € 5.142,00 € 4.214,60 | € 5.364,00 € 4.396,60 | € 5.554,50 € 4.552,60 |
| H | € 4.488,50 € 3.679,00 | € 4.710,50 € 3.861,00 | € 4.901,00 € 4.017,00 |

Prices in bold are vat included (IVA 22%)

I prezzi in grassetto si intendono iva inclusa (22%)

For fabrics see page 306

Per i tessuti si veda a p. 306

BS 5852:2006 (Clause 11 Crib 5)

ART. MD4

Baseboard finishes available / Zoccolo disponibile nei colori

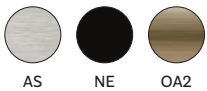

AS

NE

OA2

Surcharge COUPLE SIDEBOARD L = 44 cm (item MD4/LAT_50) = **€ 105,00** (€ 85,80 vat not included)Supplemento COPPIA ZOCCOLO LATERALE L = 44 cm (cod. MD4/LAT_50) = **€ 105,00** (€ 85,80 iva esclusa)Dimensions of Modus units are expressed in centimeters
Le misure dei moduli Modus sono espresse in centimetri

Modus

Back to back corner unit
Angolare bifacciale

MDAB

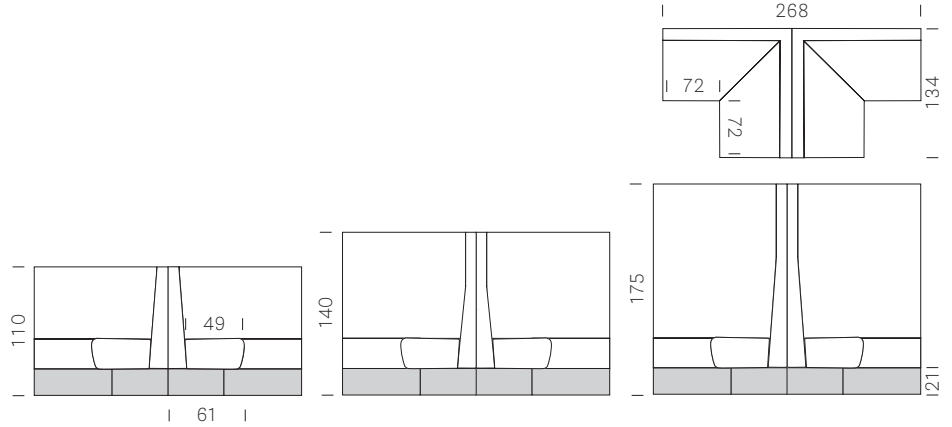

MDAB_110

| FABRIC Tessuto | SMOOTH Liscio | BUTTONS Bottoni | CAPITONÉ Capitoné | HORIZONTAL STITCHES Cuciture orizzontali | VERTICAL STITCHES Cuciture verticali |
|-------------------|--------------------------|--------------------------|--------------------------|--|--|
| E; G | € 7.067,50 € 5.792,80 | € 7.194,50 € 5.896,80 | € 8.209,50 € 6.728,80 | € 7.258,00 € 5.948,80 | € 7.702,00 € 6.312,80 |
| H | € 6.052,50 € 4.960,80 | € 6.179,50 € 5.064,80 | € 7.194,50 € 5.896,80 | € 6.242,50 € 5.116,80 | € 6.687,00 € 5.480,80 |

MDAB_140

| FABRIC Tessuto | SMOOTH Liscio | BUTTONS Bottoni | CAPITONÉ Capitoné | HORIZONTAL STITCHES Cuciture orizzontali | VERTICAL STITCHES Cuciture verticali |
|-------------------|--------------------------|--------------------------|---------------------------|--|--|
| E; G | € 8.764,50 € 7.183,80 | € 8.653,50 € 7.092,80 | € 10.366,50 € 8.496,80 | € 8.844,00 € 7.248,80 | € 8.970,50 € 7.352,80 |
| H | € 7.365,50 € 6.037,20 | € 7.683,00 € 6.297,20 | € 9.395,50 € 7.701,20 | € 7.873,00 € 6.453,20 | € 8.000,00 € 6.557,20 |

MDAB_175

| FABRIC Tessuto | SMOOTH Liscio | BUTTONS Bottoni | CAPITONÉ Capitoné | HORIZONTAL STITCHES Cuciture orizzontali |
|-------------------|--------------------------|--------------------------|---------------------------|--|
| E; G | € 8.764,50 € 7.183,80 | € 8.653,50 € 7.092,80 | € 10.366,50 € 8.496,80 | € 8.844,00 € 7.248,80 |
| H | € 7.365,50 € 6.037,20 | € 7.683,00 € 6.297,20 | € 9.395,50 € 7.701,20 | € 7.873,00 € 6.453,20 |

Prices in bold are vat included (IVA 22%)

I prezzi in grassetto si intendono iva inclusa (22%)

For fabrics see page 306

Per i tessuti si veda a p. 306

BS 5852:2006 (Clause 11 Crib 5)

ART. MD4

Baseboard finishes available / Zoccolo disponibile nei colori



Surcharge COUPLE SIDEBOARD L = 85,5 cm (item MD4/LAT_100) = € 209,50 (€ 171,60 vat not included)
Supplemento COPPIA ZOCCOLO LATERALE L = 85,5 cm (cod. MD4/LAT_100) = € 209,50 (€ 171,60 iva esclusa)

Dimensions of Modus units are expressed in centimeters
Le misure dei moduli Modus sono espresse in centimetri

Modus

Customized linear unit
Lineare personalizzato

MDP_110

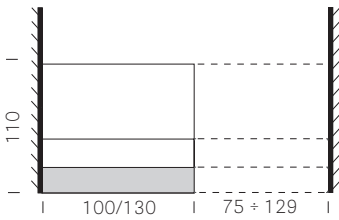

MDP_140

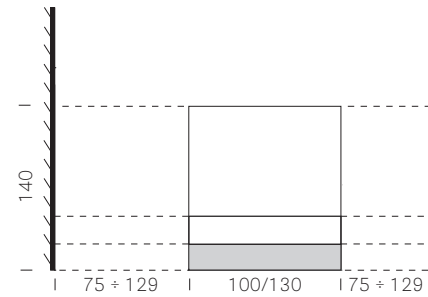

MDP_240

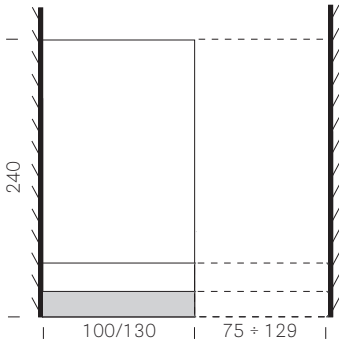

MDP_175

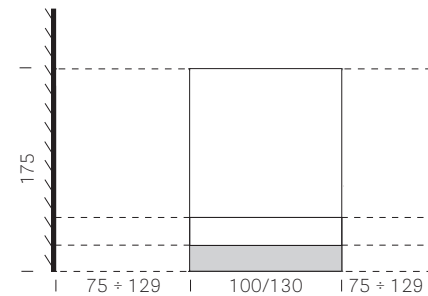

MDP_110

| FABRIC Tessuto | SMOOTH Liscio | HORIZONTAL STITCHES Cuciture orizzontali |
|-------------------|---------------------------------|--|
| E; G | € 2.120,50 € 1.738,10 | € 2.168,50 € 1.777,10 |
| H | € 1.816,00 € 1.488,50 | € 1.864,00 € 1.527,50 |

MDP_140 MDP_175

| FABRIC Tessuto | SMOOTH Liscio | HORIZONTAL STITCHES Cuciture orizzontali |
|-------------------|---------------------------------|--|
| E; G | € 2.501,50 € 2.050,10 | € 2.628,50 € 2.154,10 |
| H | € 2.211,00 € 1.812,20 | € 2.338,00 € 1.916,20 |

MDP_240

| FABRIC Tessuto | SMOOTH Liscio | HORIZONTAL STITCHES Cuciture orizzontali |
|-------------------|---------------------------------|--|
| E; G | € 3.086,50 € 2.529,80 | € 3.293,00 € 2.698,80 |
| H | € 2.693,50 € 2.207,40 | € 2.899,50 € 2.376,40 |

Prices in bold are vat included (IVA 22%)
I prezzi in grassetto si intendono iva inclusa (22%)

For fabrics see page 306
Per i tessuti si veda a p. 306

BS 5852:2006 (Clause 11 Crib 5)

ART. MD4

Baseboard finishes available / Zoccolo disponibile nei colori



Surcharge COUPLE SIDEBBOARD L = 44 cm (item MD4/LAT_50) = **€ 105,00** (€ 85,80 vat not included)
Supplemento COPPIA ZOCCOLO LATERALE L = 44 cm (cod. MD4/LAT_50) = **€ 105,00** (€ 85,80 iva esclusa)

Dimensions of Modus units are expressed in centimeters
Le misure dei moduli Modus sono espresse in centimetri

Modus

Backside laminate panel
Pannello posteriore in laminato

For Modus linear 100/130 cm
Per Modus lineare 100/130 cm

MD5_110/140/175(x100)
MD5_110/140/175(x130)

For Modus corner unit
Per Modus angolare

MD5_110/140/175(x134)

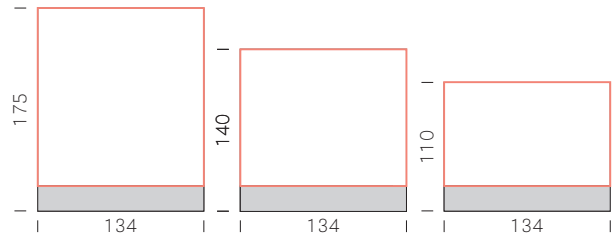
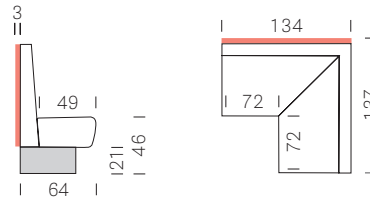
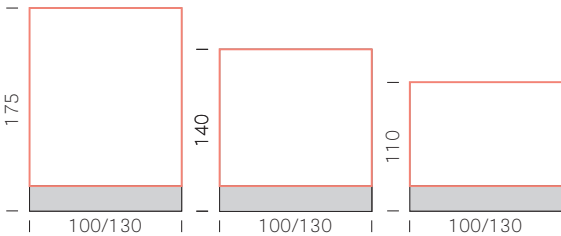
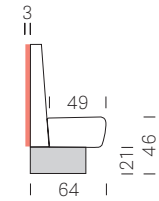

| PANEL Pannello | HEIGHT Altezza | WIDTH Larghezza | PRICE * Prezzo |
|----------------------------|-------------------|--------------------|-----------------------------|
| MD5_110x130 MD5_110x100 | 110 | 130 100 | € 460,00 € 377,00 |
| MD5_140x130 MD5_140x100 | 140 | 130 100 | € 534,50 € 438,10 |
| MD5_175x130 MD5_175x100 | 175 | 130 100 | € 534,50 € 438,10 |

| PANEL Pannello | HEIGHT Altezza | WIDTH Larghezza | PRICE * Prezzo |
|-------------------|-------------------|--------------------|-----------------------------|
| MD5_110x134 | 110 | 134 | € 460,00 € 377,00 |
| MD5_140x134 | 140 | 134 | € 534,50 € 438,10 |
| MD5_175x134 | 175 | 134 | € 534,50 € 438,10 |

Prices in bold are vat included (IVA 22%)
I prezzi in grassetto si intendono iva inclusa (22%)

* Packing and back kickboard included
Imballo e zoccolo posteriore inclusi

ART. MD5

Laminate back side panel with ABS edge, thickness 30 mm, colours available
Pannello in laminato con bordo ABS, spessore 30 mm, disponibile nei colori

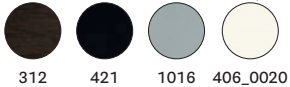

Modus

Backside upholstered panel
Pannello posteriore imbottito

For Modus linear 130 cm
Per Modus lineare 130 cm

MD5_175x130

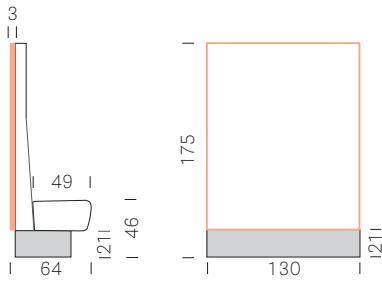

For Modus linear 100 cm
Per Modus lineare 100 cm

MD5_175x100

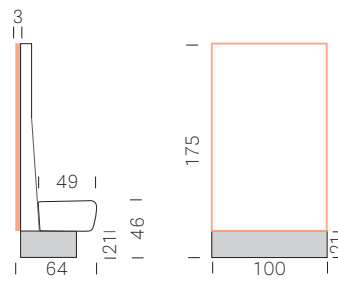

For Modus corner unit
Per Modus angolare

MD5_175x134

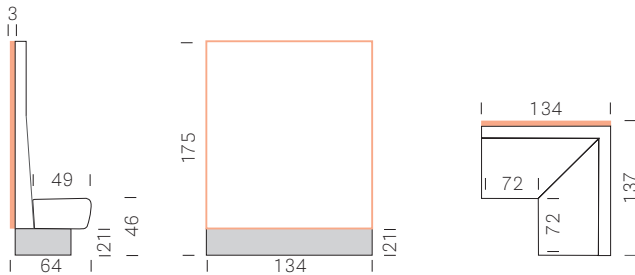

| PANEL Pannello | HEIGHT Altezza | WIDTH Larghezza | FABRIC Tessuto | PRICE * Prezzo |
|-------------------|-------------------|--------------------|-------------------|-------------------|
| MD5_175x130 | 175 | 130 | E; G | € 1.197,50 |
| MD5_175x134 | 175 | 134 | H | € 981,50 |
| | | | | € 842,50 |
| | | | | € 690,30 |

| PANEL Pannello | HEIGHT Altezza | WIDTH Larghezza | FABRIC Tessuto | PRICE * Prezzo |
|-------------------|-------------------|--------------------|-------------------|-------------------|
| MD5_175x100 | 175 | 100 | E; G | € 866,00 |
| | | | | € 709,80 |
| | | | H | € 688,50 |
| | | | | € 564,20 |

Prices in bold are vat included (IVA 22%)

I prezzi in grassetto si intendono iva inclusa (22%)

* Packing and back kickboard included
Imballo e zoccolo posteriore inclusi

For fabrics see page 306
Per i tessuti si veda a p. 306

BS 5852:2006 (Clause 11 Crib 5)

Modus 2.0

For Modus linear
Per Modus lineare

MD/2L_110 (L100 or 130)
MD/2L_140 (L100 or 130)

For Modus corner unit
Per Modus angolare

MD/2A_110
MD/2A_140

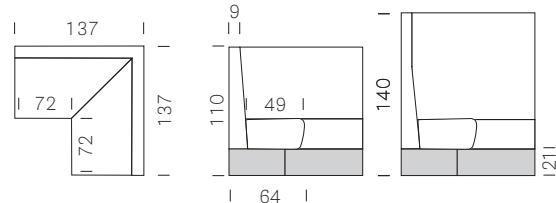
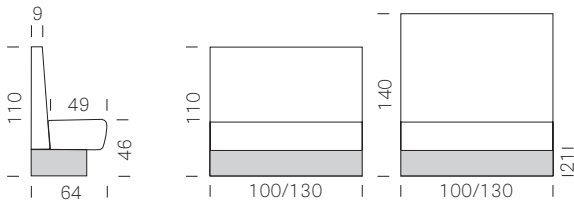

| FABRIC Tessuto | SMOOTH Liscio | HORIZONTAL STITCHES Cuciture orizzontali | VERTICAL STITCHES Cuciture verticali |
|-------------------|---------------------------------|--|--|
| E; G | € 2.739,50 € 2.245,10 | € 2.787,00 € 2.284,10 | € 2.787,00 € 2.284,10 |
| H | € 2.233,50 € 1.830,40 | € 2.281,00 € 1.869,40 | € 2.281,00 € 1.869,40 |

| FABRIC Tessuto | SMOOTH Liscio | HORIZONTAL STITCHES Cuciture orizzontali | VERTICAL STITCHES Cuciture verticali |
|-------------------|---------------------------------|--|--|
| E; G | € 5.637,00 € 4.620,20 | € 5.732,00 € 4.698,20 | € 5.732,00 € 4.698,20 |
| H | € 4.625,00 € 3.790,80 | € 4.720,00 € 3.868,80 | € 4.720,00 € 3.868,80 |

Prices in bold are vat included (IVA 22%)
I prezzi in grassetto si intendono iva inclusa (22%)

For fabrics see page 306
Per i tessuti si veda a p. 306

BS 5852:2006 (Clause 11 Crib 5)

ART. MD4

Baseboard finishes available / Zoccolo disponibile nei colori



Surcharge COUPLE SIDEBBOARD L = 44 cm (item MD4/LAT_50) = **€ 105,00** (€ 85,80 vat not included)
Supplemento COPPIA ZOCCOLO LATERALE L = 44 cm (cod. MD4/LAT_50) = **€ 105,00** (€ 85,80 iva esclusa)

Dimensions of Modus units are expressed in centimeters
Le misure dei moduli Modus sono espresse in centimetri

Modus 2.0

Back shelf
Mensola posteriore

For Modus 2.0 linear L130, H140 cm
Per Modus 2.0 lineare L130, H140 cm

K_MD/2L_M_finitura_L130

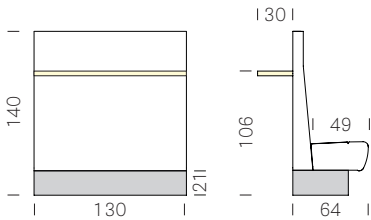

Shelf 130x30 cm, thickness 4 cm,
LAMINATE or FENIX, ABS edge in matching colour.

Mensola 130x30 cm, spessore 4 cm,
LAMINATO o FENIX, bordo ABS in tinta.

€ 285,50

€ 234,00 (VAT not included 22%)

For Modus 2.0 linear L100, H140 cm
Per Modus 2.0 lineare L100, H140 cm

K_MD/2L_M_finitura_L100

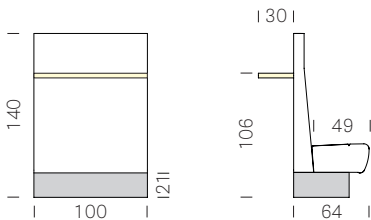

Shelf 100x30 cm, thickness 4 cm,
LAMINATE or FENIX, ABS edge in matching colour.

Mensola 100x30 cm, spessore 4 cm,
LAMINATO o FENIX, bordo ABS in tinta.

€ 285,50

€ 234,00 (VAT not included 22%)

Prices in bold are vat included (IVA 22%)

I prezzi in grassetto si intendono iva inclusa (22%)

Laminate colours / Colori laminato

FENIX colours / Colori FENIX



For Modus 2.0 corner unit, H140 cm
Per Modus 2.0 angolare, H140 cm

K_MD/2A_M_finitura_L137

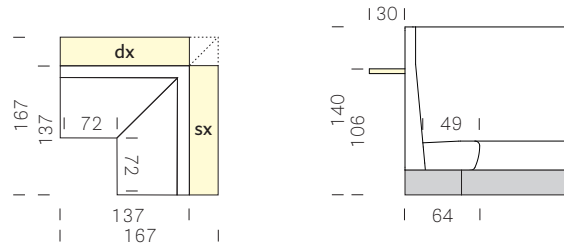

Single shelf for corner unit bench 137x30 cm, thickness 4 cm,
LAMINATE or FENIX, ABS edge matching colour.
Mention the correct shelf needed: left, right or both.

Mensola singola per panca angolare, 137x30 cm, spessore 4 cm,
LAMINATO o FENIX, bordo ABS in tinta.

Specificare se si necessita di mensola destra, sinistra o entrambe.

€ 314,50 (single shelf/mensola singola)

€ 257,40 (VAT not included 22%)

K_MD/2A_M_finitura

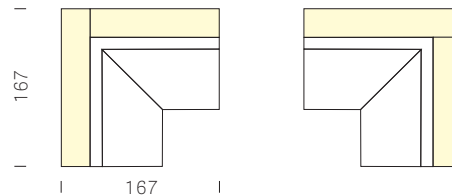

Shelf 167x167x30 cm, thickness 4 cm,
LAMINATE or FENIX, ABS edge in matching colour.

Mensola angolare 167x167x30 cm, spessore 4 cm,
LAMINATO o FENIX, bordo ABS in tinta.

€ 785,50

€ 643,50 (VAT not included 22%)

Modus 2.0



Single curved unit 60°
Curva singola 60°
MD/2C60_140

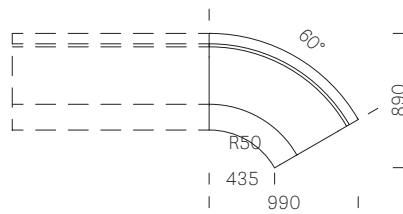
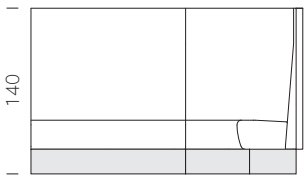

| FABRIC Tessuto | SMOOTH Liscio | HORIZONTAL STITCHES Cuciture orizzontali | VERTICAL STITCHES Cuciture verticali |
|-------------------|---------------------------------|--|--|
| E; G | € 3.537,00 € 2.899,00 | € 3.584,50 € 2.938,00 | € 3.584,50 € 2.938,00 |
| H | € 2.860,00 € 2.343,90 | € 2.907,50 € 2.382,90 | € 2.907,50 € 2.382,90 |

Prices in bold are vat included (IVA 22%)
I prezzi in grassetto si intendono iva inclusa (22%)

The single curved unit is not free standing. It must be combined with another linear or curved unit Modus 2.0
La curva singola non è autoportante. Va abbinata a un modulo lineare o a una curva Modus 2.0

Double curved unit 60°
Doppia curva singola 60°
MD/2C60_140 (2 pcs/pz)

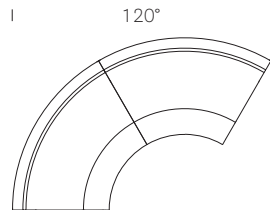
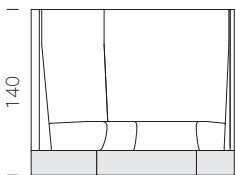

| FABRIC Tessuto | SMOOTH Liscio | HORIZONTAL STITCHES Cuciture orizzontali | VERTICAL STITCHES Cuciture verticali |
|-------------------|---------------------------------|--|--|
| E; G | € 7.074,00 € 5.798,00 | € 7.169,00 € 5.876,00 | € 7.169,00 € 5.876,00 |
| H | € 5.719,50 € 4.687,80 | € 5.814,50 € 4.765,80 | € 5.814,50 € 4.765,80 |

Prices in bold are vat included (IVA 22%)
I prezzi in grassetto si intendono iva inclusa (22%)

ART. MD4
Baseboard finishes available / Zoccolo disponibile nei colori



Surcharge COUPLE SIDEBBOARD L = 44 cm (item MD4/LAT_50) = **€ 105,00** (€ 85,80 vat not included)
Supplemento COPPIA ZOCCOLO LATERALE L = 44 cm (cod. MD4/LAT_50) = **€ 105,00** (€ 85,80 iva esclusa)

For fabrics see page 306
Per i tessuti si veda a p. 306

Dimensions of Modus units are expressed in centimeters
Le misure dei moduli Modus sono espresse in centimetri

Modus 2.0

Triple curved unit 60°
Tripla curva singola 60°

MD/2C60_140 (3 pcs/pz)

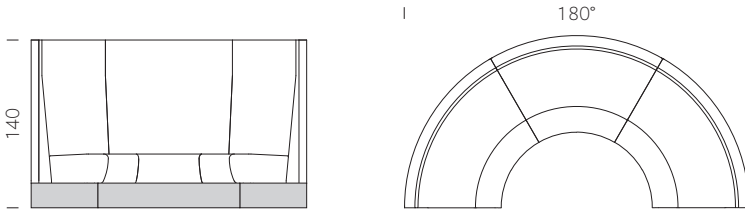

| FABRIC Tessuto | SMOOTH Liscio | HORIZONTAL STITCHES Cuciture orizzontali | VERTICAL STITCHES Cuciture verticali |
|-------------------|----------------------------------|--|--|
| E; G | € 10.610,50 € 8.697,00 | € 10.753,50 € 8.814,00 | € 10.753,50 € 8.814,00 |
| H | € 8.579,00 € 7.031,70 | € 8.721,50 € 7.148,70 | € 8.721,50 € 7.148,70 |

Prices in bold are vat included (IVA 22%)
I prezzi in grassetto si intendono iva inclusa (22%)

Quadruple curved unit 60°
Quadrupla curva singola 60°

MD/2C60_140 (4 pcs/pz)

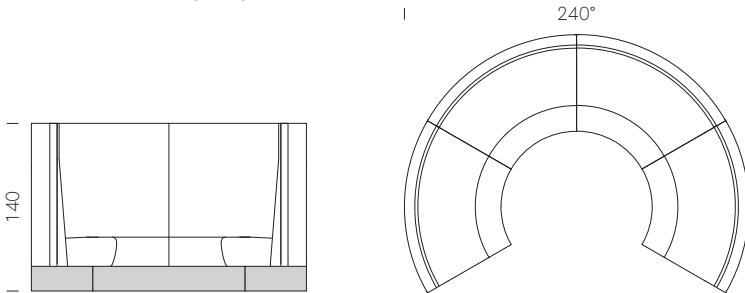

| FABRIC Tessuto | SMOOTH Liscio | HORIZONTAL STITCHES Cuciture orizzontali | VERTICAL STITCHES Cuciture verticali |
|-------------------|-----------------------------------|--|--|
| E; G | € 14.147,50 € 11.596,00 | € 14.337,50 € 11.752,00 | € 14.337,50 € 11.752,00 |
| H | € 11.438,50 € 9.375,60 | € 11.629,00 € 9.531,60 | € 11.629,00 € 9.531,60 |

Prices in bold are vat included (IVA 22%)
I prezzi in grassetto si intendono iva inclusa (22%)

ART. MD4

Baseboard finishes available / Zoccolo disponibile nei colori



Surcharge COUPLE SIDEBBOARD L = 44 cm (item MD4/LAT_50) = **€ 105,00** (€ 85,80 vat not included)
Supplemento COPPIA ZOCCOLO LATERALE L = 44 cm (cod. MD4/LAT_50) = **€ 105,00** (€ 85,80 iva esclusa)

For fabrics see page 306
Per i tessuti si veda a p. 306

Dimensions of Modus units are expressed in centimeters
Le misure dei moduli Modus sono espresse in centimetri

Modus 2.0

Back curved shelf
Mensola posteriore curva

For Modus 2.0 curved, H140 cm
Per Modus 2.0 curva, H140 cm

K_MD/2C60_M_finitura_R_50

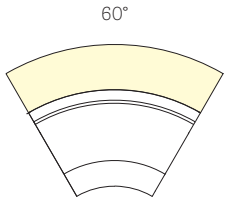

Single curved shelf, thickness 4 cm,
LAMINATE or FENIX, ABS edge in matching colour.

Mensola curva, singola, spessore 4 cm,
LAMINATO o FENIX, bordo ABS in tinta.

€ 473,00

€ 387,40 (VAT not included 22%)

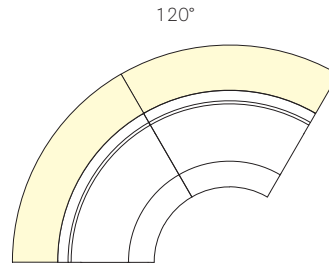

Double curved shelf, thickness 4 cm,
LAMINATE or FENIX, ABS edge in matching colour.

Mensola curva, doppia, spessore 4 cm,
LAMINATO o FENIX, bordo ABS in tinta.

€ 945,50

€ 774,80 (VAT not included 22%)

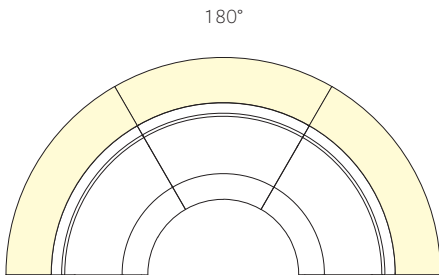

Triple curved shelf, thickness 4 cm,
LAMINATE or FENIX, ABS edge in matching colour.

Mensola curva, tripla, spessore 4 cm,
LAMINATO o FENIX, bordo ABS in tinta.

€ 1.418,00

€ 1.162,20 (VAT not included 22%)

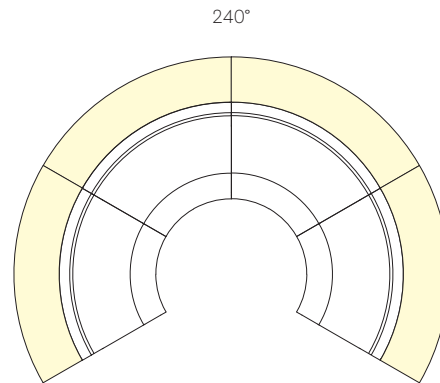

Quadruple curved shelf, thickness 4 cm,
LAMINATE or FENIX, ABS edge in matching colour.

Mensola curva, quadrupla, spessore 4 cm,
LAMINATO o FENIX, bordo ABS in tinta.

€ 1.891,00

€ 1.549,60 (VAT not included 22%)

Prices in bold are vat included (IVA 22%)
I prezzi in grassetto si intendono iva inclusa (22%)

Laminate colours / Colori laminato

FENIX colours / Colori FENIX



Mood 720



| SEAT Sedile | BACK Schienale | FRAME Telaio | LEATHER Cuio | VAT NOT INCLUDED Iva esclusa 22% |
|----------------|-------------------|-----------------|-----------------|--|
| F01+F09 | F01+F09 | F01+F09 | € 715,50 | € 586,30 |

GENUINE LEATHER FINISHES / Finiture cuio naturale



PACKING / Imballo



TECHNICAL DETAILS / Dettagli tecnici

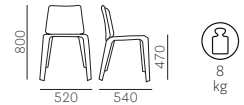

Mya 700



| SEAT Sedile | BACK Schienale | POWDER COATED Verniciato | POLISHED ALUMINIUM Alluminio lucidato | BRUSHED ALUMINIUM Alluminio satinato | VAT NOT INCLUDED Iva esclusa 22% |
|----------------|-------------------|-----------------------------|--|---|--|
| PPL | PPL | € 214,50* | € 266,50 | € 266,50 | € 175,50 |
| | | | | | € 218,40 |

*Powder coated in the same colour of the shell
Verniciato in tinta con la scocca

PPL FINISHES / Finiture PPL



PACKING / Imballo



TECHNICAL DETAILS / Dettagli tecnici



CATAS

Mya 701

TECNICA



| SEAT Sedile | BACK Schienale | POWDER COATED Verniciato | POLISHED ALUMINIUM Alluminio lucidato | BRUSHED ALUMINIUM Alluminio satinato | VAT NOT INCLUDED Iva esclusa 22% |
|----------------|-------------------|-----------------------------|--|---|--|
| PPL | TXT | € 230,00* | € 282,50 | € 282,50 | € 188,50 |
| | | | | | € 231,40 |

*Powder coated in the same colour of the shell
Verniciato in tinta con la scocca

PPL FINISHES / Finiture PPL

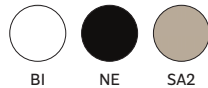

TXT FINISHES / Finiture TXT

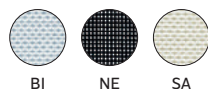

PACKING / Imballo



TECHNICAL DETAILS / Dettagli tecnici



CATAS

Mya 706/2

TECNICA



| SEAT Sedile | BACK Schienale | POWDER COATED Verniciato | BRUSHED ALUMINIUM Alluminio satinato | VAT NOT INCLUDED Iva esclusa 22% |
|----------------|-------------------|-----------------------------|---|--|
| PPL | TXT | € 341,00* | € 441,00 | € 279,50 € 361,40 |

*Powder coated in the same colour of the shell
Verniciato in tinta con la scocca

PPL FINISHES / Finiture PPL

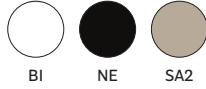

TXT FINISHES / Finiture TXT

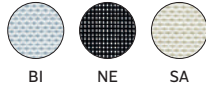

PACKING / Imballo



TECHNICAL DETAILS / Dettagli tecnici

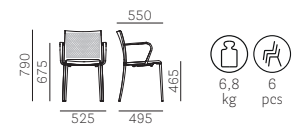

Nemea 2820



| SEAT Sedile | BACK Schienale | FRAME Telaio | ASH Frassino | VAT NOT INCLUDED Iva esclusa 22% |
|----------------|-------------------|-----------------|-----------------|--|
| FR-N1-AN-GC-BI | FR-N1-AN-GC-BI | FR-N1-AN-GC-BI | € 343,00 | € 280,80 |

FINISHES / Finiture



PACKING / Imballo



TECHNICAL DETAILS / Dettagli tecnici

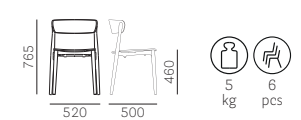

CATAS



Nemea 2821



| SEAT Sedile | BACK Schienale | FRAME Telaio | ASH Frassino | VAT NOT INCLUDED Iva esclusa 22% |
|----------------|-------------------|-----------------|-----------------|--|
| G | | | € 496,50 | € 406,90 |
| H | FR-N1-AN-GC-BI | FR-N1-AN-GC-BI | € 454,00 | € 371,80 |

For fabrics see page 306
Per i tessuti si veda a p. 306

FINISHES / Finiture



PACKING / Imballo



TECHNICAL DETAILS / Dettagli tecnici



CATAS



Nemea 2825



| SEAT Sedile | BACK Schienale | FRAME Telaio | ASH Frassino | VAT NOT INCLUDED Iva esclusa 22% |
|--------------------|--------------------|--------------------|-----------------|--|
| FR-N1-AN- GC-BI | FR-N1-AN- GC-BI | FR-N1-AN- GC-BI | € 357,00 | € 292,50 |

FINISHES / Finiture



PACKING / Imballo



TECHNICAL DETAILS / Dettagli tecnici

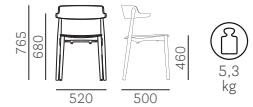

CATAS



Nemea 2826



| SEAT Sedile | BACK Schienale | FRAME Telaio | ASH Frassino | VAT NOT INCLUDED Iva esclusa 22% |
|----------------|--------------------|--------------------|-----------------|--|
| G | FR-N1-AN- GC-BI | FR-N1-AN- GC-BI | € 511,00 | € 418,60 |
| H | | | € 468,00 | € 383,50 |

For fabrics see page 306
Per i tessuti si veda a p. 306

FINISHES / Finiture



PACKING / Imballo



TECHNICAL DETAILS / Dettagli tecnici

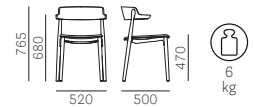

CATAS



Noa 725



| SEAT Sedile | BACK Schienale | FRAME Telaio | WHITE/BLACK POWDER COATED Verniciato bianco/nero | VAT NOT INCLUDED Iva esclusa 22% |
|---------------------|---------------------|-----------------|---|--|
| C36+C39 C83+C101 | C36+C39 C83+C101 | | € 359,00 | € 293,93 |
| G | G | Ø 16 | € 427,00 | € 349,70 |
| H | H | | € 370,50 | € 303,55 |

For fabrics see page 306
Per i tessuti si veda a p. 306

PC FINISHES / Finiture PC

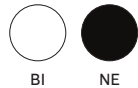

Polycarbonate outer shell, upholstered inner shell
Scocca esterna in polycarbonato, scocca interna imbottita

PACKING / Imballo



TECHNICAL DETAILS / Dettagli tecnici



CATAS

Noa 727



| SEAT Sedile | BACK Schienale | FRAME Telaio | WHITE/BLACK POWDER COATED Verniciato bianco/nero | VAT NOT INCLUDED Iva esclusa 22% |
|---------------------|---------------------|-----------------|---|--|
| C36+C39 C83+C101 | C36+C39 C83+C101 | | € 478,00 | € 391,43 |
| G | G | Ø 680 | € 546,00 | € 447,20 |
| H | H | | € 489,50 | € 401,05 |

For fabrics see page 306
Per i tessuti si veda a p. 306

PC FINISHES / Finiture PC

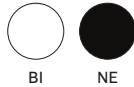

Polycarbonate outer shell, upholstered inner shell
Scocca esterna in policarbonato, scocca interna imbottita

PACKING / Imballo



TECHNICAL DETAILS / Dettagli tecnici



Noa 727/2



| SEAT Sedile | BACK Schienale | FRAME Telaio | WHITE/BLACK POWDER COATED Verniciato bianco/nero | VAT NOT INCLUDED Iva esclusa 22% |
|---------------------|---------------------|-----------------|---|--|
| C36+C39 C83+C101 | C36+C39 C83+C101 | | € 509,50 | € 417,43 |
| G | G | Ø 680 | € 577,50 | € 473,20 |
| H | H | | € 521,50 | € 427,05 |

For fabrics see page 306
Per i tessuti si veda a p. 306

PC FINISHES / Finiture PC

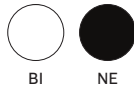

Polycarbonate outer shell, upholstered inner shell
Scocca esterna in policarbonato, scocca interna imbottita

PACKING / Imballo



TECHNICAL DETAILS / Dettagli tecnici



Noa 727/3

Gas lift device
Alzata a gas



| SEAT Sedile | BACK Schienale | FRAME Telaio | BLACK POWDER COATED Verniciato nero | VAT NOT INCLUDED Iva esclusa 22% |
|---------------------|---------------------|-----------------|--|--|
| C36+C39 C83+C101 | C36+C39 C83+C101 | | € 533,50 | € 436,93 |
| G | G | Ø 650 | € 601,50 | € 492,70 |
| H | H | | € 545,00 | € 446,55 |

For fabrics see page 306
Per i tessuti si veda a p. 306

PC FINISH / Finitura PC



Polycarbonate outer shell, upholstered inner shell
Scocca esterna in policarbonato, scocca interna imbottita

PACKING / Imballo



TECHNICAL DETAILS / Dettagli tecnici



Noa 726



| SEAT Sedile | BACK Schienale | FRAME Telaio | WHITE/BLACK POWDER COATED Verniciato bianco/nero | VAT NOT INCLUDED Iva esclusa 22% |
|---------------------|---------------------|-----------------|---|--|
| C36+C39 C83+C101 | C36+C39 C83+C101 | | € 508,00 | € 416,13 |
| G | G | Ø 16 | € 576,00 | € 471,90 |
| H | H | | € 519,50 | € 425,75 |

For fabrics see page 306
Per i tessuti si veda a p. 306

PC FINISHES / Finiture PC

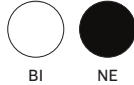

Polycarbonate outer shell, upholstered inner shell
Scocca esterna in policarbonato, scocca interna imbottita

PACKING / Imballo



TECHNICAL DETAILS / Dettagli tecnici



Noa 728



| SEAT Sedile | BACK Schienale | FRAME Telaio | WHITE/BLACK POWDER COATED Verniciato bianco/nero | VAT NOT INCLUDED Iva esclusa 22% |
|---------------------|---------------------|-----------------|---|--|
| C36+C39 C83+C101 | C36+C39 C83+C101 | | € 627,00 | € 513,63 |
| G | G | Ø 680 | € 695,00 | € 569,40 |
| H | H | | € 638,50 | € 523,25 |

For fabrics see page 306
Per i tessuti si veda a p. 306

PC FINISHES / Finiture PC

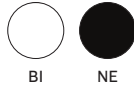

Polycarbonate outer shell, upholstered inner shell
Scocca esterna in policarbonato, scocca interna imbottita

PACKING / Imballo



TECHNICAL DETAILS / Dettagli tecnici



Noa 728/2



| SEAT Sedile | BACK Schienale | FRAME Telaio | WHITE/BLACK POWDER COATED Verniciato bianco/nero | VAT NOT INCLUDED Iva esclusa 22% |
|---------------------|---------------------|-----------------|---|--|
| C36+C39 C83+C101 | C36+C39 C83+C101 | | € 658,50 | € 539,63 |
| G | G | Ø 680 | € 726,50 | € 595,40 |
| H | H | | € 670,50 | € 549,25 |

For fabrics see page 306
Per i tessuti si veda a p. 306

PC FINISHES / Finiture PC

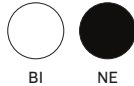

Polycarbonate outer shell, upholstered inner shell
Scocca esterna in policarbonato, scocca interna imbottita

PACKING / Imballo



TECHNICAL DETAILS / Dettagli tecnici



Noa 728/3

Gas lift device
Alzata a gas



| SEAT Sedile | BACK Schienale | FRAME Telaio | BLACK POWDER COATED Verniciato nero | VAT NOT INCLUDED Iva esclusa 22% |
|---------------------|---------------------|-----------------|--|--|
| C36+C39 C83+C101 | C36+C39 C83+C101 | | € 682,50 | € 559,13 |
| G | G | Ø 650 | € 750,50 | € 614,90 |
| H | H | | € 694,00 | € 568,75 |

For fabrics see page 306
Per i tessuti si veda a p. 306

PC FINISH / Finitura PC



NE

Polycarbonate outer shell, upholstered inner shell
Scocca esterna in policarbonato, scocca interna imbottita

PACKING / Imballo



TECHNICAL DETAILS / Dettagli tecnici



Nolita 3650

Low back
Schienale basso



| SEAT Sedile | BACK Schienale | FRAME Telaio | POWDER COATED Verniciato | VAT NOT INCLUDED Iva esclusa 22% |
|----------------|-------------------|-----------------|-----------------------------|--|
| METAL Ø 6 | METAL Ø 6 | METAL Ø 16 | € 157,50 | € 128,70 |

FINISHES / Finiture



PACKING / Imballo



TECHNICAL DETAILS / Dettagli tecnici



CATAS

Nolita 3651

High back
Schienale alto



| SEAT Sedile | BACK Schienale | FRAME Telaio | POWDER COATED Verniciato | VAT NOT INCLUDED Iva esclusa 22% |
|----------------|-------------------|-----------------|-----------------------------|--|
| METAL Ø 6 | METAL Ø 6 | METAL Ø 16 | € 167,00 | € 136,50 |

FINISHES / Finiture



PACKING / Imballo



TECHNICAL DETAILS / Dettagli tecnici

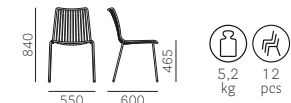

CATAS

Nolita 3655

Low back
Schienale basso



| SEAT Sedile | BACK Schienale | FRAME Telaio | POWDER COATED Verniciato | VAT NOT INCLUDED Iva esclusa 22% |
|----------------|-------------------|-----------------|-----------------------------|--|
| METAL Ø 6 | METAL Ø 6 | METAL Ø 16 | € 195,50 | € 159,90 |

FINISHES / Finiture



PACKING / Imballo



TECHNICAL DETAILS / Dettagli tecnici



CATAS

Nolita 3656

High back
Schienale alto



| SEAT Sedile | BACK Schienale | FRAME Telaio | POWDER COATED Verniciato | VAT NOT INCLUDED Iva esclusa 22% |
|----------------|-------------------|-----------------|-----------------------------|--|
| METAL Ø 6 | METAL Ø 6 | METAL Ø 16 | € 208,00 | € 170,30 |

FINISHES / Finiture



PACKING / Imballo



TECHNICAL DETAILS / Dettagli tecnici

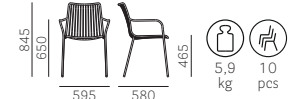

CATAS

Nolita 3650.3

Cushion only
Solo cuscino



| SEAT Sedile | FABRIC Tessuto | VAT NOT INCLUDED Iva esclusa 22% |
|----------------|--|--|
| D31 ÷ D39 | € 95,50 For chairs/armchairs Per sedie/poltrone 3650, 3651, 3655, 3656 | € 78,00 |

CUSHION COLOURS / Colori cuscino



RIM COLOURS / Colori bordino



PACKING / Imballo



TECHNICAL DETAILS / Dettagli tecnici

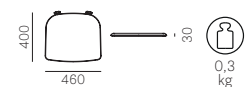

Nolita 3657



| SEAT Sedile | BACK Schienale | FRAME Telaio | POWDER COATED Verniciato | VAT NOT INCLUDED Iva esclusa 22% |
|----------------|-------------------|------------------------|-----------------------------|--|
| METAL Ø 6 | METAL Ø 6 | METAL Ø 16 H 650 | € 190,50 | € 156,00 |

FINISHES / Finiture



PACKING / Imballo



TECHNICAL DETAILS / Dettagli tecnici



Nolita 3658



| SEAT Sedile | BACK Schienale | FRAME Telaio | POWDER COATED Verniciato | VAT NOT INCLUDED Iva esclusa 22% |
|----------------|-------------------|------------------------|-----------------------------|--|
| METAL Ø 6 | METAL Ø 6 | METAL Ø 16 H 750 | € 200,00 | € 163,80 |

FINISHES / Finiture



PACKING / Imballo



TECHNICAL DETAILS / Dettagli tecnici



Nolita 3657.3

Cushion only
Solo cuscino



| SEAT Sedile | FABRIC Tessuto | VAT NOT INCLUDED Iva esclusa 22% |
|----------------|--|--|
| D31 ÷ D39 | € 95,50 For stools Per sgabelli 3657, 3658 | € 78,00 |

CUSHION COLOURS / Colori cuscino



RIM COLOURS / Colori bordino



PACKING / Imballo



TECHNICAL DETAILS / Dettagli tecnici

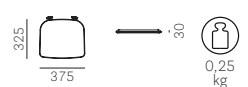

Nolita 3659

LOUNGE



| SEAT Sedile | BACK Schienale | FRAME Telaio | POWDER COATED Verniciato | VAT NOT INCLUDED Iva esclusa 22% |
|----------------|-------------------|-----------------|-----------------------------|--|
| METAL Ø 6 | METAL Ø 6 | METAL Ø 16 | € 222,50 | € 182,00 |

FINISHES / Finiture



PACKING / Imballo



TECHNICAL DETAILS / Dettagli tecnici



Nolita 3659.3

LOUNGE
Cushion only
Solo cuscino



| SEAT Sedile | FABRIC Tessuto | VAT NOT INCLUDED Iva esclusa 22% |
|----------------|--|--|
| D31+D39 | € 95,50 For armchair Per poltrona 3659 | € 78,00 |

CUSHION COLOURS / Colori cuscino

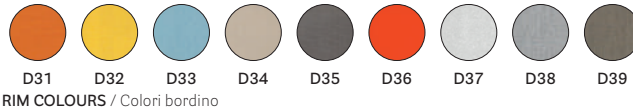

RIM COLOURS / Colori bordino



PACKING / Imballo



TECHNICAL DETAILS / Dettagli tecnici

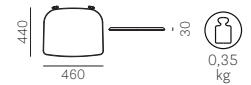

Nolita 3654

CHAISE LONGUE



| SEAT Sedile | BACK Schienale | FRAME Telaio | POWDER COATED Verniciato | VAT NOT INCLUDED Iva esclusa 22% |
|----------------|-------------------|-----------------|-----------------------------|--|
| METAL Ø 6 | METAL Ø 6 | METAL Ø 20 | € 952,00 | € 780,00 |

FINISHES / Finiture



PACKING / Imballo



TECHNICAL DETAILS / Dettagli tecnici



Nolita 3654.7

CHAISE LONGUE
Cushion only
Solo cuscino



| SEAT Sedile | FABRIC Tessuto | VAT NOT INCLUDED Iva esclusa 22% |
|----------------|-------------------|--|
| D31+D39 | € 531,50 | € 435,50 |

CUSHION COLOURS / Colori cuscino

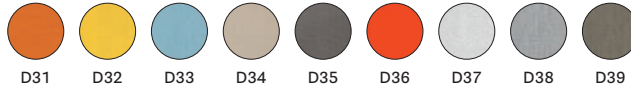

RIM COLOURS / Colori bordino



PACKING / Imballo



TECHNICAL DETAILS / Dettagli tecnici

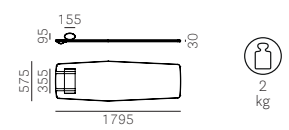

Nym 2830



| SEAT Sedile | BACK Schienale | FRAME Telaio | ASH Frassino | VAT NOT INCLUDED Iva esclusa 22% |
|--------------------|--------------------|--------------------|-----------------|--|
| FR-N1-AN- GC-BI | FR-N1-AN- GC-BI | FR-N1-AN- GC-BI | € 484,00 | € 396,50 |

FINISHES / Finiture



PACKING / Imballo



TECHNICAL DETAILS / Dettagli tecnici

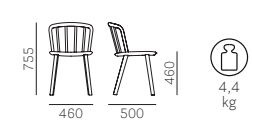

CATAS



Nym 2831



| SEAT Sedile | BACK Schienale | FRAME Telaio | ASH Frassino | VAT NOT INCLUDED Iva esclusa 22% |
|---------------------|--------------------|--------------------|-----------------|--|
| C36+C39 C83+C101 | | | € 588,50 | € 482,30 |
| E | | | € 638,00 | € 522,60 |
| G | FR-N1-AN- GC-BI | FR-N1-AN- GC-BI | € 638,00 | € 522,60 |
| H | | | € 595,00 | € 487,50 |
| P | | | € 655,50 | € 536,90 |

For fabrics see page 306
Per i tessuti si veda a p. 306

FINISHES / Finiture



PACKING / Imballo



TECHNICAL DETAILS / Dettagli tecnici

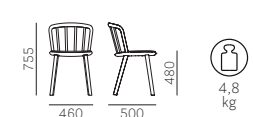

CATAS



Nym 2832

SOFT



| SEAT Sedile | BACK Schienale | FRAME Telaio | ASH Frassino | VAT NOT INCLUDED Iva esclusa 22% |
|---------------------|---------------------|--------------------|-----------------|--|
| C36+C39 C83+C101 | C36+C39 C83+C101 | | € 693,50 | € 568,10 |
| E | E | FR-N1-AN- GC-BI | € 868,00 | € 711,10 |
| G | G | | € 814,00 | € 666,90 |
| H | H | | € 709,00 | € 581,10 |

For fabrics see page 306
Per i tessuti si veda a p. 306

FINISHES / Finiture



PACKING / Imballo



TECHNICAL DETAILS / Dettagli tecnici



CATAS



Nym 2840



| SEAT Sedile | BACK Schienale | FRAME Telaio | ASH Frassino | VAT NOT INCLUDED Iva esclusa 22% |
|--------------------|--------------------|--------------------|-----------------|--|
| FR-N1-AN- GC-BI | FR-N1-AN- GC-BI | FR-N1-AN- GC-BI | € 658,50 | € 539,50 |

FINISHES / Finiture



PACKING / Imballo



TECHNICAL DETAILS / Dettagli tecnici

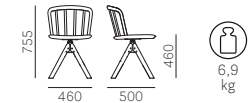

Nym 2841



| SEAT Sedile | BACK Schienale | FRAME Telaio | ASH Frassino | VAT NOT INCLUDED Iva esclusa 22% |
|---------------------|--------------------|--------------------|-----------------|--|
| C36+C39 C83+C101 | | | € 763,00 | € 625,30 |
| E | | | € 812,50 | € 665,60 |
| G | FR-N1-AN- GC-BI | FR-N1-AN- GC-BI | € 812,50 | € 665,60 |
| H | | | € 769,50 | € 630,50 |
| P | | | € 829,50 | € 679,90 |

For fabrics see page 306
Per i tessuti si veda a p. 306

FINISHES / Finiture



PACKING / Imballo



TECHNICAL DETAILS / Dettagli tecnici



Nym 2842

SOFT



| SEAT Sedile | BACK Schienale | FRAME Telaio | ASH Frassino | VAT NOT INCLUDED Iva esclusa 22% |
|---------------------|---------------------|--------------------|-----------------|--|
| C36+C39 C83+C101 | C36+C39 C83+C101 | | € 807,50 | € 661,70 |
| E | E | FR-N1-AN- GC-BI | € 982,00 | € 804,70 |
| G | G | | € 928,00 | € 760,50 |
| H | H | | € 823,50 | € 674,70 |

For fabrics see page 306
Per i tessuti si veda a p. 306

FINISHES / Finiture



PACKING / Imballo



TECHNICAL DETAILS / Dettagli tecnici



Nym 2850



| SEAT Sedile | BACK Schienale | FRAME Telaio | ASH Frassino WHITE/BLACK POWDER COATED Verniciato bianco/nero | VAT NOT INCLUDED Iva esclusa 22% |
|--------------------|--------------------|-----------------|--|--|
| FR-N1-AN- GC-BI | FR-N1-AN- GC-BI | Ø 11 | € 436,50 | € 357,50 |

FINISHES / Finiture



PACKING / Imballo



TECHNICAL DETAILS / Dettagli tecnici

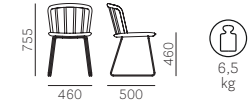

Nym 2851



| SEAT Sedile | BACK Schienale | FRAME Telaio | ASH Frassino WHITE/BLACK POWDER COATED Verniciato bianco/nero | VAT NOT INCLUDED Iva esclusa 22% |
|---------------------|--------------------|-----------------|--|--|
| C36+C39 C83+C101 | | | € 541,00 | € 443,30 |
| E | FR-N1-AN- GC-BI | Ø 11 | € 590,00 | € 483,60 |
| G | | | € 590,00 | € 483,60 |
| H | | | € 547,50 | € 448,50 |
| P | | | € 607,50 | € 497,90 |

For fabrics see page 306
Per i tessuti si veda a p. 306

FINISHES / Finiture



PACKING / Imballo



TECHNICAL DETAILS / Dettagli tecnici

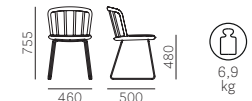

Nym 2852

SOFT



| SEAT Sedile | BACK Schienale | FRAME Telaio | WHITE/BLACK POWDER COATED Verniciato bianco/nero | VAT NOT INCLUDED Iva esclusa 22% |
|---------------------|---------------------|-----------------|---|--|
| C36+C39 C83+C101 | C36+C39 C83+C101 | | € 596,50 | € 488,80 |
| E | E | Ø 11 | € 771,00 | € 631,80 |
| G | G | | € 717,00 | € 587,60 |
| H | H | | € 612,50 | € 501,80 |

For fabrics see page 306
Per i tessuti si veda a p. 306

PACKING / Imballo



TECHNICAL DETAILS / Dettagli tecnici



Nym 2835



| SEAT Sedile | BACK Schienale | FRAME Telaio | ASH Frassino | VAT NOT INCLUDED Iva esclusa 22% |
|--------------------|--------------------|--------------------|-----------------|--|
| FR-N1-AN- GC-BI | FR-N1-AN- GC-BI | FR-N1-AN- GC-BI | € 531,50 | € 435,50 |

FINISHES / Finiture



PACKING / Imballo



TECHNICAL DETAILS / Dettagli tecnici



CATAS



Nym 2836



| SEAT Sedile | BACK Schienale | FRAME Telaio | ASH Frassino | VAT NOT INCLUDED Iva esclusa 22% |
|---------------------|--------------------|--------------------|-----------------|--|
| C36+C39 C83+C101 | | | € 636,00 | € 521,30 |
| E | | | € 685,50 | € 561,60 |
| G | FR-N1-AN- GC-BI | FR-N1-AN- GC-BI | € 685,50 | € 561,60 |
| H | | | € 642,50 | € 526,50 |
| P | | | € 703,00 | € 575,90 |

For fabrics see page 306
Per i tessuti si veda a p. 306

FINISHES / Finiture



PACKING / Imballo



TECHNICAL DETAILS / Dettagli tecnici

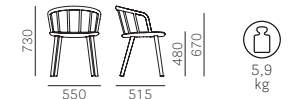

CATAS



Nym 2837

SOFT



| SEAT Sedile | BACK Schienale | FRAME Telaio | ASH Frassino | VAT NOT INCLUDED Iva esclusa 22% |
|---------------------|---------------------|--------------------|-----------------|--|
| C36+C39 C83+C101 | C36+C39 C83+C101 | | € 769,50 | € 630,50 |
| E | E | FR-N1-AN- GC-BI | € 980,50 | € 803,40 |
| G | G | | € 914,00 | € 748,80 |
| H | H | | € 790,00 | € 647,40 |

For fabrics see page 306
Per i tessuti si veda a p. 306

FINISHES / Finiture



PACKING / Imballo



TECHNICAL DETAILS / Dettagli tecnici

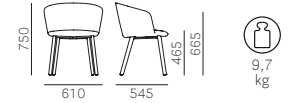

Nym 2845



| SEAT Sedile | BACK Schienale | FRAME Telaio | ASH Frassino | VAT NOT INCLUDED Iva esclusa 22% |
|--------------------|--------------------|--------------------|-----------------|--|
| FR-N1-AN- GC-BI | FR-N1-AN- GC-BI | FR-N1-AN- GC-BI | € 706,00 | € 578,50 |

FINISHES / Finiture



PACKING / Imballo



TECHNICAL DETAILS / Dettagli tecnici

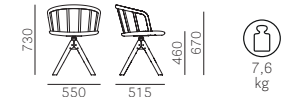

Nym 2846



| SEAT Sedile | BACK Schienale | FRAME Telaio | ASH Frassino | VAT NOT INCLUDED Iva esclusa 22% |
|---------------------|--------------------|--------------------|-----------------|--|
| C36+C39 C83+C101 | | | € 810,50 | € 664,30 |
| E | | | € 860,00 | € 704,60 |
| G | FR-N1-AN- GC-BI | FR-N1-AN- GC-BI | € 860,00 | € 704,60 |
| H | | | € 817,00 | € 669,50 |
| P | | | € 877,50 | € 718,90 |

For fabrics see page 306
Per i tessuti si veda a p. 306

FINISHES / Finiture



PACKING / Imballo



TECHNICAL DETAILS / Dettagli tecnici



Nym 2847

SOFT



| SEAT Sedile | BACK Schienale | FRAME Telaio | ASH Frassino | VAT NOT INCLUDED Iva esclusa 22% |
|---------------------|---------------------|--------------------|-------------------|--|
| C36+C39 C83+C101 | C36+C39 C83+C101 | | € 883,50 | € 724,10 |
| E | E | FR-N1-AN- GC-BI | € 1.094,50 | € 897,00 |
| G | G | | € 1.028,00 | € 842,40 |
| H | H | | € 904,50 | € 741,00 |

For fabrics see page 306
Per i tessuti si veda a p. 306

FINISHES / Finiture



PACKING / Imballo



TECHNICAL DETAILS / Dettagli tecnici

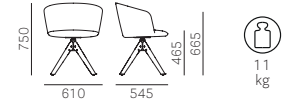

Nym 2855



| SEAT Sedile | BACK Schienale | FRAME Telaio | ASH Frassino WHITE/BLACK POWDER COATED Verniciato bianco/nero | VAT NOT INCLUDED Iva esclusa 22% |
|--------------------|--------------------|-----------------|--|--|
| FR-N1-AN- GC-BI | FR-N1-AN- GC-BI | Ø 11 | € 484,00 | € 396,50 |

FINISHES / Finiture



PACKING / Imballo



TECHNICAL DETAILS / Dettagli tecnici

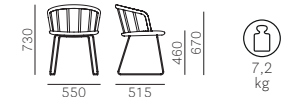

Nym 2856



| SEAT Sedile | BACK Schienale | FRAME Telaio | ASH Frassino WHITE/BLACK POWDER COATED Verniciato bianco/nero | VAT NOT INCLUDED Iva esclusa 22% |
|---------------------|--------------------|-----------------|--|--|
| C36+C39 C83+C101 | | | € 588,50 | € 482,30 |
| E | FR-N1-AN- GC-BI | Ø 11 | € 638,00 | € 522,60 |
| G | | | € 638,00 | € 522,60 |
| H | | | € 595,00 | € 487,50 |
| P | | | € 655,50 | € 536,90 |

For fabrics see page 306
Per i tessuti si veda a p. 306

FINISHES / Finiture



PACKING / Imballo



TECHNICAL DETAILS / Dettagli tecnici



Nym 2857

SOFT



| SEAT Sedile | BACK Schienale | FRAME Telaio | WHITE/BLACK POWDER COATED Verniciato bianco/nero | VAT NOT INCLUDED Iva esclusa 22% |
|---------------------|---------------------|-----------------|---|--|
| C36+C39 C83+C101 | C36+C39 C83+C101 | | € 676,00 | € 553,80 |
| E | E | Ø 11 | € 887,00 | € 726,70 |
| G | G | | € 820,00 | € 672,10 |
| H | H | | € 696,50 | € 570,70 |

For fabrics see page 306
Per i tessuti si veda a p. 306

PACKING / Imballo



TECHNICAL DETAILS / Dettagli tecnici

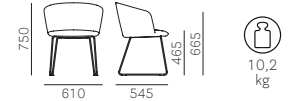

Nym 2838



| SEAT Sedile | BACK Schienale | FRAME Telaio | ASH Frassino | VAT NOT INCLUDED Iva esclusa 22% |
|--------------------|--------------------|-----------------|----------------------------------|--|
| | | | BRUSHED S/STEEL Inox satinato | |
| FR-N1-AN- GC-BI | FR-N1-AN- GC-BI | H655 | € 628,50 | € 514,80 |

FINISHES / Finiture



PACKING / Imballo



TECHNICAL DETAILS / Dettagli tecnici



CATAS



Nym 2838/A



| SEAT Sedile | BACK Schienale | FRAME Telaio | ASH Frassino | VAT NOT INCLUDED Iva esclusa 22% |
|---------------------|--------------------|-----------------|----------------------------------|--|
| | | | BRUSHED S/STEEL Inox satinato | |
| C36+C39 C83+C101 | | | € 733,00 | € 600,60 |
| E | FR-N1-AN- GC-BI | H675 | € 782,00 | € 640,90 |
| G | | | € 782,00 | € 640,90 |
| H | | | € 739,50 | € 605,80 |
| P | | | € 799,50 | € 655,20 |

For fabrics see page 306
Per i tessuti si veda a p. 306

FINISHES / Finiture



PACKING / Imballo



TECHNICAL DETAILS / Dettagli tecnici



CATAS



Nym 2839



| SEAT Sedile | BACK Schienale | FRAME Telaio | ASH Frassino | VAT NOT INCLUDED Iva esclusa 22% |
|--------------------|--------------------|-----------------|----------------------------------|--|
| | | | BRUSHED S/STEEL Inox satinato | |
| FR-N1-AN- GC-BI | FR-N1-AN- GC-BI | H755 | € 634,50 | € 520,00 |

FINISHES / Finiture



PACKING / Imballo



TECHNICAL DETAILS / Dettagli tecnici



CATAS



Nym 2839/A



| SEAT Sedile | BACK Schienale | FRAME Telaio | ASH Frassino | VAT NOT INCLUDED Iva esclusa 22% |
|---------------------|--------------------|-----------------|----------------------------------|--|
| | | | BRUSHED S/STEEL Inox satinato | |
| C36+C39 C83+C101 | FR-N1-AN- GC-BI | H775 | € 739,50 | € 605,80 |
| E | | | € 788,50 | € 646,10 |
| G | | | € 788,50 | € 646,10 |
| H | | | € 745,50 | € 611,00 |
| P | | | € 806,00 | € 660,40 |

For fabrics see page 306
Per i tessuti si veda a p. 306

FINISHES / Finiture



PACKING / Imballo



TECHNICAL DETAILS / Dettagli tecnici



CATAS



Nym 2848



| SEAT Sedile | BACK Schienale | FRAME Telaio | ASH Frassino | VAT NOT INCLUDED Iva esclusa 22% |
|--------------------|--------------------|-----------------|--|--|
| | | | BLACK POWDER COATED Verniciato nero | |
| FR-N1-AN- GC-BI | FR-N1-AN- GC-BI | H650 | € 777,50 | € 637,00 |

FINISHES / Finiture



PACKING / Imballo



TECHNICAL DETAILS / Dettagli tecnici



CATAS



Nym 2848/A



| SEAT Sedile | BACK Schienale | FRAME Telaio | ASH Frassino | VAT NOT INCLUDED Iva esclusa 22% |
|---------------------|--------------------|-----------------|--|--|
| | | | BLACK POWDER COATED Verniciato nero | |
| C36+C39 C83+C101 | FR-N1-AN- GC-BI | H670 | € 882,00 | € 722,80 |
| E | | | € 931,00 | € 763,10 |
| G | | | € 931,00 | € 763,10 |
| H | | | € 888,50 | € 728,00 |
| P | | | € 948,50 | € 777,40 |

For fabrics see page 306
Per i tessuti si veda a p. 306

FINISHES / Finiture



PACKING / Imballo



TECHNICAL DETAILS / Dettagli tecnici



Nym 2849



| SEAT Sedile | BACK Schienale | FRAME Telaio | ASH Frassino | VAT NOT INCLUDED Iva esclusa 22% |
|--------------------|--------------------|-----------------|--|--|
| | | | BLACK POWDER COATED Verniciato nero | |
| FR-N1-AN- GC-BI | FR-N1-AN- GC-BI | H750 | € 783,50 | € 642,20 |

FINISHES / Finiture



PACKING / Imballo



TECHNICAL DETAILS / Dettagli tecnici



Nym 2849/A



| SEAT Sedile | BACK Schienale | FRAME Telaio | ASH Frassino | VAT NOT INCLUDED Iva esclusa 22% |
|---------------------|--------------------|-----------------|--|--|
| | | | BLACK POWDER COATED Verniciato nero | |
| C36+C39 C83+C101 | FR-N1-AN- GC-BI | H770 | € 888,50 | € 728,00 |
| E | | | € 937,50 | € 768,30 |
| G | | | € 937,50 | € 768,30 |
| H | | | € 895,00 | € 733,20 |
| P | | | € 955,00 | € 782,60 |

For fabrics see page 306
Per i tessuti si veda a p. 306

FINISHES / Finiture



PACKING / Imballo



TECHNICAL DETAILS / Dettagli tecnici



Nym 2858



| SEAT Sedile | BACK Schienale | FRAME Telaio | ASH Frassino | VAT NOT INCLUDED Iva esclusa 22% |
|--------------------|--------------------|-----------------|---|--|
| | | | WHITE/BLACK POWDER COATED Verniciato bianco/nero | |
| FR-N1-AN- GC-BI | FR-N1-AN- GC-BI | Ø 11 H650 | € 501,50 | € 410,80 |

FINISHES / Finiture



PACKING / Imballo



TECHNICAL DETAILS / Dettagli tecnici



Nym 2858/A



| SEAT Sedile | BACK Schienale | FRAME Telaio | ASH Frassino | VAT NOT INCLUDED Iva esclusa 22% |
|---------------------|--------------------|-----------------|---|--|
| | | | WHITE/BLACK POWDER COATED Verniciato bianco/nero | |
| C36+C39 C83+C101 | FR-N1-AN- GC-BI | Ø 11 H670 | € 606,00 | € 496,60 |
| E | | | € 655,50 | € 536,90 |
| G | | | € 655,50 | € 536,90 |
| H | | | € 612,50 | € 501,80 |
| P | | | € 672,50 | € 551,20 |

For fabrics see page 306
Per i tessuti si veda a p. 306

FINISHES / Finiture



PACKING / Imballo



TECHNICAL DETAILS / Dettagli tecnici



Nym 2859



| SEAT Sedile | BACK Schienale | FRAME Telaio | ASH Frassino | VAT NOT INCLUDED Iva esclusa 22% |
|--------------------|--------------------|-----------------|---|--|
| | | | WHITE/BLACK POWDER COATED Verniciato bianco/nero | |
| FR-N1-AN- GC-BI | FR-N1-AN- GC-BI | Ø 11 H750 | € 508,00 | € 416,00 |

FINISHES / Finiture



PACKING / Imballo



TECHNICAL DETAILS / Dettagli tecnici



Nym 2859/A



| SEAT Sedile | BACK Schienale | FRAME Telaio | ASH Frassino | VAT NOT INCLUDED Iva esclusa 22% |
|---------------------|--------------------|-----------------|---|--|
| | | | WHITE/BLACK POWDER COATED Verniciato bianco/nero | |
| C36+C39 C83+C101 | | | € 612,50 | € 501,80 |
| E | | | € 661,50 | € 542,10 |
| G | FR-N1-AN- GC-BI | Ø 11 H770 | € 661,50 | € 542,10 |
| H | | | € 619,00 | € 507,00 |
| P | | | € 679,00 | € 556,40 |

For fabrics see page 306
Per i tessuti si veda a p. 306

FINISHES / Finiture

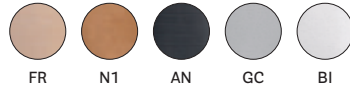

PACKING / Imballo



TECHNICAL DETAILS / Dettagli tecnici

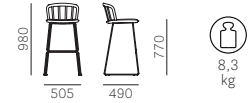

Osaka 2810



| SEAT Sedile | BACK Schienale | FRAME Telaio | ASH Frassino | VAT NOT INCLUDED Iva esclusa 22% |
|--------------------|--------------------|--------------------|-----------------|--|
| FR-N1-AN- GC-BI | FR-N1-AN- GC-BI | FR-N1-AN- GC-BI | € 316,00 | € 258,70 |

FINISHES / Finiture



PACKING / Imballo



TECHNICAL DETAILS / Dettagli tecnici

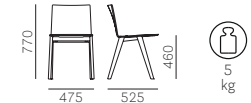

Osaka 2811



| SEAT Sedile | BACK Schienale | FRAME Telaio | ASH Frassino | VAT NOT INCLUDED Iva esclusa 22% |
|----------------|-------------------|--------------------|-----------------|--|
| G | G | FR-N1-AN- GC-BI | € 619,50 | € 507,65 |
| N | N | | € 652,00 | € 534,30 |

For fabrics see page 306
Per i tessuti si veda a p. 306

FINISHES / Finiture



Upcharge for double-colour upholstery: fabric € 14,50, leather € 48,00 (fabric € 11,70, leather € 39,00 vat not included)
Supplemento tappezzeria bicolore: tessuto € 14,50, pelle € 48,00 (tessuto € 11,70, pelle € 39,00 iva esclusa)

PACKING / Imballo



TECHNICAL DETAILS / Dettagli tecnici

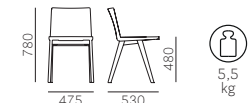

Osaka 2815



| SEAT Sedile | BACK Schienale | FRAME Telaio | ASH Frassino | VAT NOT INCLUDED Iva esclusa 22% |
|--------------------|--------------------|--------------------|-----------------|--|
| FR-N1-AN- GC-BI | FR-N1-AN- GC-BI | FR-N1-AN- GC-BI | € 384,00 | € 314,60 |

FINISHES / Finiture

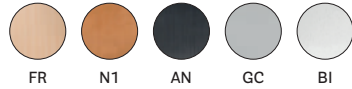

PACKING / Imballo



TECHNICAL DETAILS / Dettagli tecnici



Osaka 2816



| SEAT Sedile | BACK Schienale | FRAME Telaio | ASH Frassino | VAT NOT INCLUDED Iva esclusa 22% |
|----------------|-------------------|--------------------|-----------------|--|
| G | G | FR-N1-AN- GC-BI | € 745,00 | € 610,35 |
| N | N | | € 782,00 | € 640,90 |

For fabrics see page 306
Per i tessuti si veda a p. 306

FINISHES / Finiture



Upcharge for double-colour upholstery: fabric **€ 14,50**, leather **€ 71,50** (fabric € 11,70, leather € 58,50 vat not included)
Supplemento tappezzeria bicolore: tessuto **€ 14,50**, pelle **€ 71,50** (tessuto € 11,70, pelle € 58,50 iva esclusa)

PACKING / Imballo



TECHNICAL DETAILS / Dettagli tecnici



Osaka Metal 5711



| SEAT Sedile | BACK Schienale | FRAME Telaio | ASH Frassino | | VAT NOT INCLUDED Iva esclusa 22% |
|----------------|-------------------|-----------------|--|--------------------|--|
| | | | WHITE/BLACK POWDER COATED Verniciato bianco/nero | CHROMED Cromato | |
| FR-AN | FR-AN | Ø 16 | € 247,50 | € 247,50 | € 202,80 |

FINISHES / Finiture



PACKING / Imballo



TECHNICAL DETAILS / Dettagli tecnici



Osaka Metal 5714



| SEAT Sedile | BACK Schienale | FRAME Telaio | ASH Frassino | | VAT NOT INCLUDED Iva esclusa 22% |
|----------------|-------------------|-----------------|--|--------------------|--|
| | | | WHITE/BLACK POWDER COATED Verniciato bianco/nero | CHROMED Cromato | |
| FR-AN | FR-AN | Ø 11 | € 260,50 | € 260,50 | € 213,20 |

FINISHES / Finiture



PACKING / Imballo



TECHNICAL DETAILS / Dettagli tecnici



CATAS



Osaka Metal 5721

SOFT



| SEAT Sedile | BACK Schienale | FRAME Telaio | WHITE/BLACK POWDER COATED Verniciato bianco/nero | | VAT NOT INCLUDED Iva esclusa 22% |
|----------------|-------------------|-----------------|--|----------|--|
| | | | CHROMED Cromato | | |
| G | G | Ø 16 | € 551,50 | € 551,50 | € 451,75 |
| N | N | | € 584,00 | € 584,00 | € 478,40 |

For fabrics see page 306
Per i tessuti si veda a p. 306

Upcharge for double-colour upholstery: fabric € 14,50, leather € 48,00 (fabric € 11,70, leather € 39,00 vat not included)
Supplemento tappezzeria bicolore: tessuto € 14,50, pelle € 48,00 (tessuto € 11,70, pelle € 39,00 iva esclusa)

PACKING / Imballo



TECHNICAL DETAILS / Dettagli tecnici



CATAS

Osaka Metal 5724

SOFT



| SEAT Sedile | BACK Schienale | FRAME Telaio | WHITE/BLACK POWDER COATED Verniciato bianco/nero | | VAT NOT INCLUDED Iva esclusa 22% |
|----------------|-------------------|-----------------|--|----------|--|
| | | | CHROMED Cromato | | |
| G | G | Ø 11 | € 564,00 | € 564,00 | € 462,15 |
| N | N | | € 596,50 | € 596,50 | € 488,80 |

For fabrics see page 306
Per i tessuti si veda a p. 306

Upcharge for double-colour upholstery: fabric € 14,50, leather € 48,00 (fabric € 11,70, leather € 39,00 vat not included)
Supplemento tappezzeria bicolore: tessuto € 14,50, pelle € 48,00 (tessuto € 11,70, pelle € 39,00 iva esclusa)

PACKING / Imballo



TECHNICAL DETAILS / Dettagli tecnici

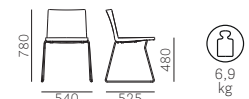

CATAS

Osaka Metal 5712



| SEAT Sedile | BACK Schienale | FRAME Telaio | ASH Frassino | | VAT NOT INCLUDED Iva esclusa 22% |
|----------------|-------------------|-----------------|--|--------------------|--|
| | | | WHITE/BLACK POWDER COATED Verniciato bianco/nero | CHROMED Cromato | |
| FR-AN | FR-AN | Ø 16 | € 346,00 | | € 283,40 |
| | | | | € 355,50 | € 291,20 |

Finitura bracciolo: solo FR
Armrest finish: FR only

FINISHES / Finiture



PACKING / Imballo



TECHNICAL DETAILS / Dettagli tecnici



CATAS



Osaka Metal 5715



| SEAT Sedile | BACK Schienale | FRAME Telaio | ASH Frassino | | VAT NOT INCLUDED Iva esclusa 22% |
|----------------|-------------------|-----------------|--|--------------------|--|
| | | | WHITE/BLACK POWDER COATED Verniciato bianco/nero | CHROMED Cromato | |
| FR-AN | FR-AN | Ø 11 | € 363,50 | | € 297,70 |
| | | | | € 382,50 | € 313,30 |

Finitura bracciolo: solo FR
Armrest finish: FR only

FINISHES / Finiture



PACKING / Imballo



TECHNICAL DETAILS / Dettagli tecnici

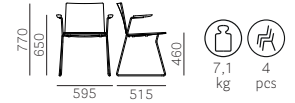

CATAS



Osaka Metal 5722

SOFT



| SEAT Sedile | BACK Schienale | FRAME Telaio | WHITE/BLACK POWDER COATED Verniciato bianco/nero | VAT NOT INCLUDED Iva esclusa 22% | CHROMED Cromato | VAT NOT INCLUDED Iva esclusa 22% |
|----------------|-------------------|-----------------|--|--|--------------------|--|
| G | G | Ø 16 | € 649,50 | € 532,35 | € 659,00 | € 540,15 |
| N | N | | € 682,00 | € 559,00 | € 691,50 | € 566,80 |

Armrest finish: FR only
Finitura bracciolo: solo FR
For fabrics see page 306
Per i tessuti si veda a p. 306

Upcharge for double-colour upholstery: fabric € 14,50, leather € 48,00 (fabric € 11,70, leather € 39,00 vat not included)
Supplemento tappezzeria bicolore: tessuto € 14,50, pelle € 48,00 (tessuto € 11,70, pelle € 39,00 iva esclusa)

PACKING / Imballo



TECHNICAL DETAILS / Dettagli tecnici



CATAS

Osaka Metal 5725

SOFT



| SEAT Sedile | BACK Schienale | FRAME Telaio | WHITE/BLACK POWDER COATED Verniciato bianco/nero | VAT NOT INCLUDED Iva esclusa 22% | CHROMED Cromato | VAT NOT INCLUDED Iva esclusa 22% |
|----------------|-------------------|-----------------|--|--|--------------------|--|
| G | G | Ø 11 | € 667,00 | € 546,65 | € 686,00 | € 562,25 |
| N | N | | € 699,50 | € 573,30 | € 718,50 | € 588,90 |

Armrest finish: FR only
Finitura bracciolo: solo FR
For fabrics see page 306
Per i tessuti si veda a p. 306

Upcharge for double-colour upholstery: fabric **€ 14,50**, leather **€ 48,00** (fabric € 11,70, leather € 39,00 vat not included)
Supplemento tappezzeria bicolore: tessuto **€ 14,50**, pelle **€ 48,00** (tessuto € 11,70, pelle € 39,00 iva esclusa)

PACKING / Imballo

TECHNICAL DETAILS / Dettagli tecnici

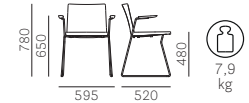

CATAS

Osaka Metal 5716



| SEAT Sedile | BACK Schienale | FRAME Telaio | ASH Frassino | | VAT NOT INCLUDED Iva esclusa 22% |
|----------------|-------------------|-----------------|--|--------------------|--|
| | | | WHITE/BLACK POWDER COATED Verniciato bianco/nero | CHROMED Cromato | |
| FR-AN | FR-AN | Ø 11 H 650 | € 266,50 | | € 218,40 |
| | | | | € 271,50 | € 222,30 |

FINISHES / Finiture



PACKING / Imballo

TECHNICAL DETAILS / Dettagli tecnici

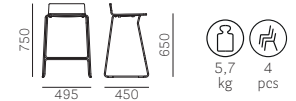

Osaka Metal 5717

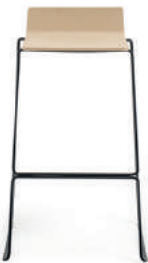

| SEAT Sedile | BACK Schienale | FRAME Telaio | ASH Frassino | | VAT NOT INCLUDED Iva esclusa 22% |
|----------------|-------------------|-----------------|--|--------------------|--|
| | | | WHITE/BLACK POWDER COATED Verniciato bianco/nero | CHROMED Cromato | |
| FR-AN | FR-AN | Ø 11 H 750 | € 270,00 | | € 221,00 |
| | | | | € 274,50 | € 224,90 |

FINISHES / Finiture



PACKING / Imballo

TECHNICAL DETAILS / Dettagli tecnici



Osaka Metal 5729

SOFT
LOUNGE



| SEAT Sedile | BACK Schienale | FRAME Telaio | WHITE/BLACK POWDER COATED Verniciato bianco/nero | VAT NOT INCLUDED Iva esclusa 22% |
|----------------|-------------------|-----------------|--|--|
| G | G | Ø 20 | € 787,00 | € 644,80 |
| N | N | | € 826,50 | € 677,30 |

Armrest finish: FR only
Finitura bracciolo: solo FR
For fabrics see page 306
Per i tessuti si veda a p. 306

Upcharge for double-colour upholstery: fabric **€ 14,50**, leather **€ 48,00** (fabric € 11,70, leather € 39,00 vat not included)
Supplemento tappezzeria bicolore: tessuto **€ 14,50**, pelle **€ 48,00** (tessuto € 11,70, pelle € 39,00 iva esclusa)

PACKING / Imballo

TECHNICAL DETAILS / Dettagli tecnici



CATAS



Pasha 660



| SEAT Sedile | BACK Schienale | FRAME Telaio | POLYCARBONATE Policarbonato | VAT NOT INCLUDED Iva esclusa 22% |
|----------------|-------------------|-----------------|--------------------------------|--|
| PC | PC | PC | € 333,50 | € 273,00 |

PC FINISHES / Finiture PC

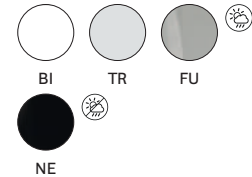

PACKING / Imballo

TECHNICAL DETAILS / Dettagli tecnici

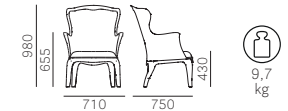

CATAS

Pasha 660.3

Cushion only
Solo cuscino



| SEAT Sedile | FABRIC Tessuto | VAT NOT INCLUDED Iva esclusa 22% |
|--------------------------------|-------------------|--|
| C36+C39 fabric / tessuto | € 193,50 | € 158,60 |
| H40+H53 velvet / velluto | € 165,00 | € 135,20 |

For fabrics see page 306
Per i tessuti si veda a p. 306

PACKING / Imballo

TECHNICAL DETAILS / Dettagli tecnici

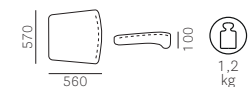

Pasha 661

POUF



| SEAT Sedile | FRAME Telaio | POLYCARBONATE Policarbonato | VAT NOT INCLUDED Iva esclusa 22% |
|----------------|-----------------|--------------------------------|--|
| PC | PC | € 151,00 | € 123,50 |

PC FINISHES / Finiture PC



BI

TR

FU



NE

PACKING / Imballo



TECHNICAL DETAILS / Dettagli tecnici

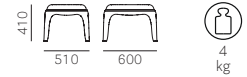

Pasha 662

Tray only
Solo vassoio



| SEAT Sedile | FRAME Telaio | THERMOFORMADE METHACRYLATE Metacrilato termoformato | VAT NOT INCLUDED Iva esclusa 22% |
|----------------|-----------------|--|--|
| ME | ME | € 119,00 | € 97,50 |

ME FINISHES / Finiture ME



BI



NE

PACKING / Imballo



TECHNICAL DETAILS / Dettagli tecnici

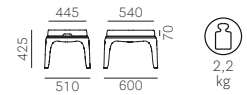

Plural

Without armrests
Senza braccioli



| CODE Codice | SEAT Sedile | BACK Schienale | POWDER COATED Verniciato | VAT NOT INCLUDED Iva esclusa 22% |
|--|---|-------------------|-----------------------------|--|
| P02003 | PPL | PPL | € 1.229,50 | € 1.007,50 |
| Floor fixing kit: surcharge € 79,50 (€ 65,00 vat not included) - Item P02003_FIX Kit di fissaggio a terra: supplemento € 79,50 (€ 65,00 iva esclusa) - Art.P02003_FIX | | | | |
| P02004 | PPL | PPL | € 1.443,50 | € 1.183,00 |
| Floor fixing kit: surcharge € 79,50 (€ 65,00 vat not included) - Item P02004_FIX Kit di fissaggio a terra: supplemento € 79,50 (€ 65,00 iva esclusa) - Art.P02004_FIX | | | | |
| P02006 | PPL | PPL | € 2.220,50 | € 1.820,00 |
| Floor fixing kit: surcharge € 119,00 (€ 97,50 vat not included) - Item P02006_FIX Kit di fissaggio a terra: supplemento € 119,00 (€ 97,50 iva esclusa) - Art.P02006_FIX | | | | |
| P02009 | PPL | PPL | € 3.172,00 | € 2.600,00 |
| Floor fixing kit: surcharge € 159,00 (€ 130,00 vat not included) - Item P02009_FIX Kit di fissaggio a terra: supplemento € 159,00 (€ 130,00 iva esclusa) - Art.P02009_FIX | | | | |
| P020_USB | USB kit: surcharge € 111,50 (€ 91,00 vat not included) - electrification excluded Kit USB: supplemento € 111,50 (€ 91,00 iva esclusa) - elettrificazione esclusa | | | |

PPL FINISHES / Finiture PPL



BI NE BE

POWDER COATED FINISHES / Finiture verniciato



BI NERO AL

CATAS

TECHNICAL DETAILS / Dettagli tecnici

P02003

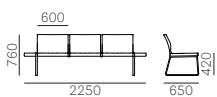

1 pc KD
MC 0,395

37
kg

P02004

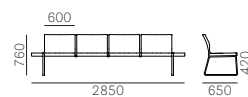

1 pc KD
MC 0,395

47
kg

P02006

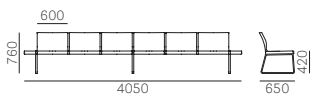

1 pc KD
MC 0,73

68
kg

P02009

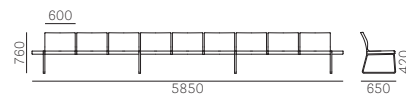

1 pc KD
MC 1,035

99
kg

Plural

With armrests
Con braccioli

| CODE Codice | SEAT Sedile | BACK Schienale | POWDER COATED Verniciato | VAT NOT INCLUDED Iva esclusa 22% |
|-----------------|--|-------------------|-----------------------------|--|
| P02013 | PPL | PPL | € 1.364,00 | € 1.118,00 |
| | Floor fixing kit: surcharge € 79,50 (€ 65,00 vat not included) - Item P02013_FIX Kit di fissaggio a terra: supplemento € 79,50 (€ 65,00 iva esclusa) - Art.P02013_FIX | | | |
| P02014 | PPL | PPL | € 1.610,00 | € 1.319,50 |
| | Floor fixing kit: surcharge € 79,50 (€ 65,00 vat not included) - Item P02014_FIX Kit di fissaggio a terra: supplemento € 79,50 (€ 65,00 iva esclusa) - Art.P02014_FIX | | | |
| P02016 | PPL | PPL | € 2.379,00 | € 1.950,00 |
| | Floor fixing kit: surcharge € 119,00 (€ 97,50 vat not included) - Item P02016_FIX Kit di fissaggio a terra: supplemento € 119,00 (€ 97,50 iva esclusa) - Art.P02016_FIX | | | |
| P02019 | PPL | PPL | € 3.410,00 | € 2.795,00 |
| | Floor fixing kit: surcharge € 159,00 (€ 130,00 vat not included) - Item P02019_FIX Kit di fissaggio a terra: supplemento € 159,00 (€ 130,00 iva esclusa) - Art.P02019_FIX | | | |
| P020_USB | USB kit: surcharge € 111,50 (€ 91,00 vat not included) - electrification excluded Kit USB: supplemento € 111,50 (€ 91,00 iva esclusa) - elettrificazione esclusa | | | |

PPL FINISHES / Finiture PPL

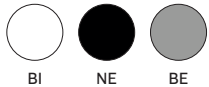

BI NE BE

POWDER COATED FINISHES / Finiture verniciato



BI NERO AL

CATAS

TECHNICAL DETAILS / Dettagli tecnici

P02013

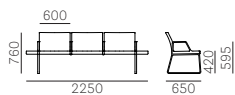
39,5
kg

P02014

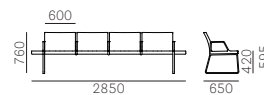
50
kg

P02016

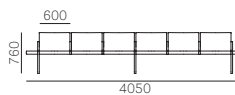
72
kg

P02019

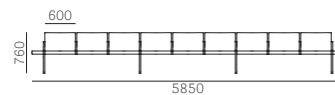
104,5
kg

Plural

With outside armrests
Con braccioli esterni



| CODE Codice | SEAT Sedile | BACK Schienale | POWDER COATED Verniciato | VAT NOT INCLUDED Iva esclusa 22% |
|--|---|-------------------|-----------------------------|--|
| P02023 | PPL | PPL | € 1.332,50 | € 1.092,00 |
| Floor fixing kit: surcharge € 79,50 (€ 65,00 vat not included) - Item P02023_FIX Kit di fissaggio a terra: supplemento € 79,50 (€ 65,00 iva esclusa) - Art.P02023_FIX | | | | |
| P02024 | PPL | PPL | € 1.578,50 | € 1.293,50 |
| Floor fixing kit: surcharge € 79,50 (€ 65,00 vat not included) - Item P02024_FIX Kit di fissaggio a terra: supplemento € 79,50 (€ 65,00 iva esclusa) - Art.P02024_FIX | | | | |
| P02026 | PPL | PPL | € 2.284,00 | € 1.872,00 |
| Floor fixing kit: surcharge € 119,00 (€ 97,50 vat not included) - Item P02026_FIX Kit di fissaggio a terra: supplemento € 119,00 (€ 97,50 iva esclusa) - Art.P02026_FIX | | | | |
| P02029 | PPL | PPL | € 3.251,50 | € 2.665,00 |
| Floor fixing kit: surcharge € 159,00 (€ 130,00 vat not included) - Item P02029_FIX Kit di fissaggio a terra: supplemento € 159,00 (€ 130,00 iva esclusa) - Art.P02029_FIX | | | | |
| P020_USB | USB kit: surcharge € 111,50 (€ 91,00 vat not included) - electrification excluded Kit USB: supplemento € 111,50 (€ 91,00 iva esclusa) - elettrificazione esclusa | | | |

PPL FINISHES / Finiture PPL



POWDER COATED FINISHES / Finiture verniciato



CATAS

TECHNICAL DETAILS / Dettagli tecnici

P02023

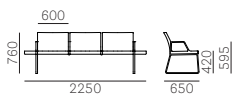

1 pc KD
MC 0,395

P02024

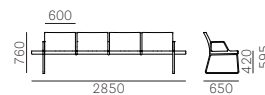

1 pc KD
MC 0,395

P02026

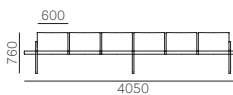

1 pc KD
MC 0,73

P02029

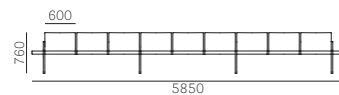

1 pc KD
MC 1,035

Plural

SOFT
Without armrests
Senza braccioli



| CODE Codice | SEAT Sedile | BACK Schienale | POWDER COATED Verniciato | VAT NOT INCLUDED Iva esclusa 22% |
|--|---|-------------------|-----------------------------|--|
| P02103 | C | PPL | € 1.743,50 | € 1.428,70 |
| | H | | € 1.762,50 | € 1.444,30 |
| Floor fixing kit: surcharge € 79,50 (€ 65,00 vat not included) - Item P02103_FIX Kit di fissaggio a terra: supplemento € 79,50 (€ 65,00 iva esclusa) - Art.P02103_FIX | | | | |
| P02104 | C | PPL | € 2.128,50 | € 1.744,60 |
| | H | | € 2.154,00 | € 1.765,40 |
| Floor fixing kit: surcharge € 79,50 (€ 65,00 vat not included) - Item P02104_FIX Kit di fissaggio a terra: supplemento € 79,50 (€ 65,00 iva esclusa) - Art.P02104_FIX | | | | |
| P02106 | C | PPL | € 3.248,50 | € 2.662,40 |
| | H | | € 3.286,50 | € 2.693,60 |
| Floor fixing kit: surcharge € 119,00 (€ 97,50 vat not included) - Item P02106_FIX Kit di fissaggio a terra: supplemento € 119,00 (€ 97,50 iva esclusa) - Art.P02106_FIX | | | | |
| P02109 | C | PPL | € 4.714,00 | € 3.863,60 |
| | H | | € 4.771,00 | € 3.910,40 |
| Floor fixing kit: surcharge € 159,00 (€ 130,00 vat not included) - Item P02109_FIX Kit di fissaggio a terra: supplemento € 159,00 (€ 130,00 iva esclusa) - Art.P02109_FIX | | | | |
| P020_USB | USB kit: surcharge € 111,50 (€ 91,00 vat not included) - electrification excluded Kit USB: supplemento € 111,50 (€ 91,00 iva esclusa) - elettrificazione esclusa | | | |

PPL FINISHES / Finiture PPL

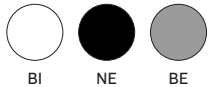

POWDER COATED FINISHES / Finiture verniciato



For fabrics see page 306
Per i tessuti si veda a p. 306

TECHNICAL DETAILS / Dettagli tecnici

P02103

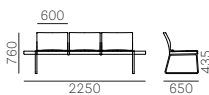

1 pc KD
MC 0,395

P02104

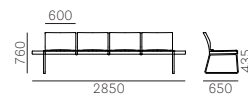

1 pc KD
MC 0,395

P02106

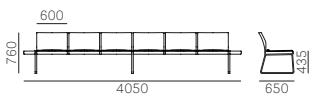

1 pc KD
MC 0,73

P02109

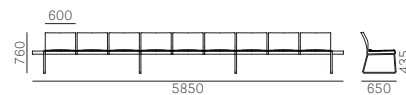

1 pc KD
MC 1,035

Plural

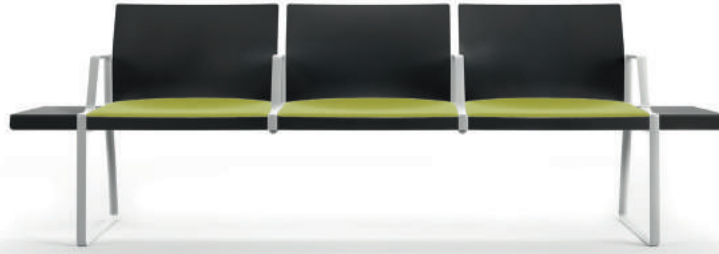
SOFT
With armrests
Con braccioli

| CODE Codice | SEAT Sedile | BACK Schienale | POWDER COATED Verniciato | VAT NOT INCLUDED Iva esclusa 22% |
|--|---|-------------------|-----------------------------|--|
| P02113 | C | PPL | € 1.878,00 | € 1.539,20 |
| | H | | € 1.897,00 | € 1.554,80 |
| Floor fixing kit: surcharge € 79,50 (€ 65,00 vat not included) - Item P02113_FIX Kit di fissaggio a terra: supplemento € 79,50 (€ 65,00 iva esclusa) - Art.P02113_FIX | | | | |
| P02114 | C | PPL | € 2.295,00 | € 1.881,10 |
| | H | | € 2.320,50 | € 1.901,90 |
| Floor fixing kit: surcharge € 79,50 (€ 65,00 vat not included) - Item P02114_FIX Kit di fissaggio a terra: supplemento € 79,50 (€ 65,00 iva esclusa) - Art.P02114_FIX | | | | |
| P02116 | C | PPL | € 3.407,00 | € 2.792,40 |
| | H | | € 3.445,00 | € 2.823,60 |
| Floor fixing kit: surcharge € 119,00 (€ 97,50 vat not included) - Item P02116_FIX Kit di fissaggio a terra: supplemento € 119,00 (€ 97,50 iva esclusa) - Art.P02116_FIX | | | | |
| P02119 | C | PPL | € 4.951,50 | € 4.058,60 |
| | H | | € 5.009,00 | € 4.105,40 |
| Floor fixing kit: surcharge € 159,00 (€ 130,00 vat not included) - Item P02119_FIX Kit di fissaggio a terra: supplemento € 159,00 (€ 130,00 iva esclusa) - Art.P02119_FIX | | | | |
| P020_USB | USB kit: surcharge € 111,50 (€ 91,00 vat not included) - electrification excluded Kit USB: supplemento € 111,50 (€ 91,00 iva esclusa) - elettrificazione esclusa | | | |

PPL FINISHES / Finiture PPL

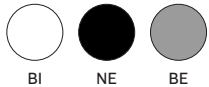

POWDER COATED FINISHES / Finiture verniciato



CATAS

For fabrics see page 306
Per i tessuti si veda a p. 306

TECHNICAL DETAILS / Dettagli tecnici

P02113

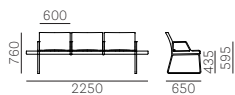
1 pc KD
MC 0,415

P02114

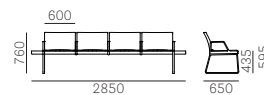
1 pc KD
MC 0,42

P02116

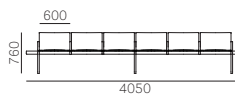
1 pc KD
MC 0,80

P02119

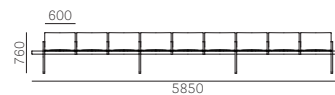
1 pc KD
MC 1,08

Plural

SOFT
With outside armrests
Con braccioli esterni



| CODE Codice | SEAT Sedile | BACK Schienale | POWDER COATED Verniciato | VAT NOT INCLUDED Iva esclusa 22% |
|--|---|-------------------|-----------------------------|--|
| P02123 | C | PPL | € 1.846,50 | € 1.513,20 |
| | H | | € 1.865,50 | € 1.528,80 |
| Floor fixing kit: surcharge € 79,50 (€ 65,00 vat not included) - Item P02123_FIX Kit di fissaggio a terra: supplemento € 79,50 (€ 65,00 iva esclusa) - Art.P02123_FIX | | | | |
| P02124 | C | PPL | € 2.263,50 | € 1.855,10 |
| | H | | € 2.289,00 | € 1.875,90 |
| Floor fixing kit: surcharge € 79,50 (€ 65,00 vat not included) - Item P02124_FIX Kit di fissaggio a terra: supplemento € 79,50 (€ 65,00 iva esclusa) - Art.P02124_FIX | | | | |
| P02126 | C | PPL | € 3.312,00 | € 2.714,40 |
| | H | | € 3.350,00 | € 2.745,60 |
| Floor fixing kit: surcharge € 119,00 (€ 97,50 vat not included) - Item P02126_FIX Kit di fissaggio a terra: supplemento € 119,00 (€ 97,50 iva esclusa) - Art.P02126_FIX | | | | |
| P02129 | C | PPL | € 4.793,00 | € 3.928,60 |
| | H | | € 4.850,00 | € 3.975,40 |
| Floor fixing kit: surcharge € 159,00 (€ 130,00 vat not included) - Item P02129_FIX Kit di fissaggio a terra: supplemento € 159,00 (€ 130,00 iva esclusa) - Art.P02129_FIX | | | | |
| P020_USB | USB kit: surcharge € 111,50 (€ 91,00 vat not included) - electrification excluded Kit USB: supplemento € 111,50 (€ 91,00 iva esclusa) - elettrificazione esclusa | | | |

PPL FINISHES / Finiture PPL

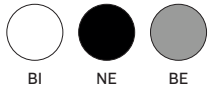

POWDER COATED FINISHES / Finiture verniciato



For fabrics see page 306
Per i tessuti si veda a p. 306

TECHNICAL DETAILS / Dettagli tecnici

P02123

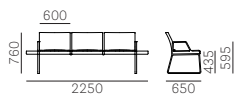

1 pc KD
MC 0,395

P02124

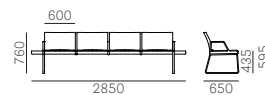

1 pc KD
MC 0,395

P02126

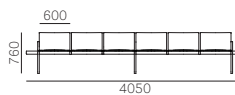

1 pc KD
MC 0,73

P02129

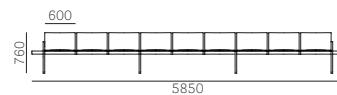

1 pc KD
MC 1,035

Plus 630



| SEAT Sedile | BACK Schienale | FRAME Telaio | POLYPROPYLENE Polipropilene | VAT NOT INCLUDED Iva esclusa 22% |
|----------------|-------------------|-----------------|--------------------------------|--|
| PPL | PPL | PPL | € 125,50 | € 102,70 |

PPL FINISHES / Finiture PPL



PACKING / Imballo



TECHNICAL DETAILS / Dettagli tecnici

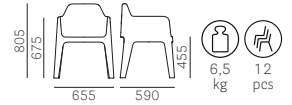

PRODUCT CERTIFIED
FOR LOW CHEMICAL
EMISSIONS
UL.COM/MSG
UL 2818

Plus 630.3

Cushion only
Solo cuscino



| SEAT Sedile | FABRIC Tessuto | VAT NOT INCLUDED Iva esclusa 22% |
|----------------|-------------------|--|
| D31 + D39 | € 155,50 | € 127,40 |

FINISHES / Finiture



PACKING / Imballo



TECHNICAL DETAILS / Dettagli tecnici

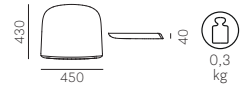

Plus Air 631

LOUNGE



| SEAT Sedile | BACK Schienale | FRAME Telaio | POLYETHYLENE Polietilene | VAT NOT INCLUDED Iva esclusa 22% |
|----------------|-------------------|-----------------|-----------------------------|--|
| PET | PET | PET | € 255,50 | € 209,30 |

PET FINISH / Finitura PET



PACKING / Imballo



TECHNICAL DETAILS / Dettagli tecnici

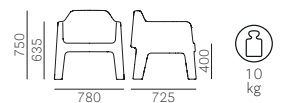

Plus Air 631.3

Cushion only
Solo cuscino



| SEAT Sedile | FABRIC Tessuto | VAT NOT INCLUDED Iva esclusa 22% |
|----------------|-------------------|--|
| D31+D39 | € 171,50 | € 140,40 |

FINISHES / Finiture

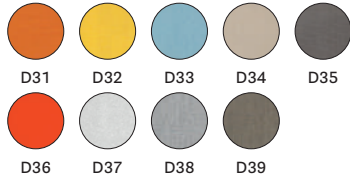

PACKING / Imballo



TECHNICAL DETAILS / Dettagli tecnici

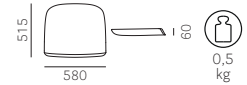

Plus Air 636

SOFA



| SEAT Sedile | BACK Schienale | FRAME Telaio | POLYETHYLENE Polietilene | VAT NOT INCLUDED Iva esclusa 22% |
|----------------|-------------------|-----------------|-----------------------------|--|
| PET | PET | PET | € 603,00 | € 494,00 |

PET FINISH / Finitura PET



PACKING / Imballo



TECHNICAL DETAILS / Dettagli tecnici

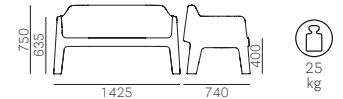

CATAS

Plus Air 636.3

Cushion only
Solo cuscino



| SEAT Sedile | FABRIC Tessuto | VAT NOT INCLUDED Iva esclusa 22% |
|----------------|-------------------|--|
| D31+D39 | € 285,50 | € 234,00 |

FINISHES / Finiture

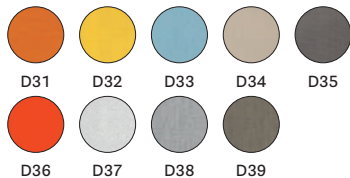

PACKING / Imballo



TECHNICAL DETAILS / Dettagli tecnici

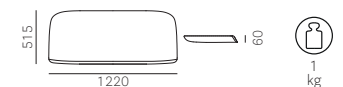

Queen 650



| SEAT Sedile | BACK Schienale | FRAME Telaio | POLYCARBONATE Policarbonato | VAT NOT INCLUDED Iva esclusa 22% |
|----------------|-------------------|-----------------|--------------------------------|--|
| PC | PC | PC | € 135,00 | € 110,50 |

PC FINISHES / Finiture PC



PACKING / Imballo



TECHNICAL DETAILS / Dettagli tecnici

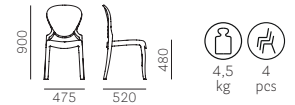

Queen 650.3

Cushion only
Solo cuscino



| SEAT Sedile | FABRIC Tessuto | VAT NOT INCLUDED Iva esclusa 22% |
|--------------------------------|-------------------|--|
| H40+H53 velvet / velluto | € 146,00 | € 119,60 |

For fabrics see page 306
Per i tessuti si veda a p. 306

PACKING / Imballo



TECHNICAL DETAILS / Dettagli tecnici

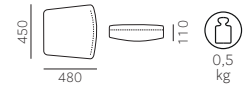

Remind 3735



| SEAT Sedile | BACK Schienale | FRAME Telaio | POLYPROPYLENE Polipropilene | VAT NOT INCLUDED Iva esclusa 22% |
|----------------|-------------------|-----------------|--------------------------------|--|
| PPL | PPL | PPL | € 130,50 | € 106,60 |

PPL FINISHES / Finiture PPL



PACKING / Imballo



TECHNICAL DETAILS / Dettagli tecnici



Remind Pixel



| SEAT Sedile | BACK Schienale | FRAME Telaio | POLYPROPYLENE Polipropilene | VAT NOT INCLUDED Iva esclusa 22% |
|----------------|-------------------|-----------------|--------------------------------|--|
| PPL | PPL | PPL | € 127,00 | € 104,00 |

Pack of 300 pixels
Confezione da 300 pixel

PPL FINISHES / Finiture PPL



RO



RA



| CODE Codice | SEAT Sedile | BACK Schienale | FRAME Telaio | WHITE/SAND POWDER COATED Verniciato bianco/sabbia | WHITE POWDER COATED Verniciato bianco | FABRIC Tessuto | PVC PVC | VAT NOT INCLUDED Iva esclusa 22% |
|---|----------------|-------------------|------------------------------|---|---|----------------------------------|-----------------|--|
| REVA_D Three seats sofa Divano a tre posti REVA_D + REVA.3 | D31 + D39 | D31 + D39 | BI100E SA200E + TXT | € 2.720,00 € 2.913,50 | | | | € 2.229,50 € 2.388,10 |
| REVA_P Armchair Poltrona REVA_P + REVA.3 | D31 + D39 | D31 + D39 | BI100E SA200E + TXT | € 1.754,50 € 1.948,00 | | | | € 1.437,80 € 1.596,40 |
| REVA.3 Optional side pillow Cuscino laterale opzionale | D31 + D39 | D31 + D39 | | | | € 97,00 (1 pc / 1 pz) | | € 79,30 |
| REVA_D/COVER Protective cover (sofa) Copertura protettiva (divano) | PVC | PVC | | | | | € 127,00 | € 104,00 |
| REVA_P/COVER Protective cover (armchair) Copertura protettiva (poltrona) | PVC | PVC | | | | | € 114,50 | € 93,60 |
| REVA.13 Pillowcase for lateral cushion Federa cuscino laterale | D31 + D39 | D31 + D39 | | | | € 56,00 (1 pc / 1 pz) | | € 45,50 |
| REVA.17 Pillowcase for seat cushion Federa cuscino sedile | D31 + D39 | | | | | € 182,50 (1 pc / 1 pz) | | € 149,50 |
| REVA.18 Pillowcase for backrest cushion Federa cuscino schienale | | D31 + D39 | | | | € 121,00 (1 pc / 1 pz) | | € 98,80 |
| REVA_L Sun lounger Lettino REVA_L + REVA_L.3 | TXT (BI) | TXT (BI) | BI100E + TXT (BI) | | € 1.665,50 € 2.268,00 | | | € 1.365,00 € 1.859,00 |
| REVA_L.3 Cushion for sun lounger Cuscino per lettino | D31 + D39 | D31 + D39 | | | | € 603,00 | | € 494,00 |

FABRIC FINISHES / Finiture tessuto



TXT FINISHES / Finiture TXT

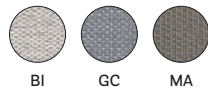

POWDER COATED FINISHES / Finiture verniciato



TECHNICAL DETAILS / Dettagli tecnici

REVA_D

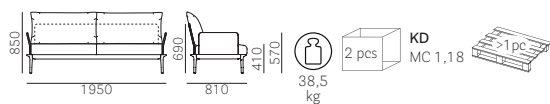

REVA_P



REVA.3

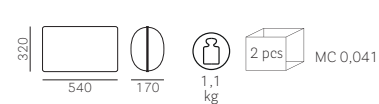

REVA_L



REVA_L.3

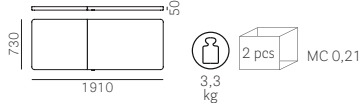

Rubik 580



| SEAT Sedile | FRAME Telaio | POLYCARBONATE Policarbonato | VAT NOT INCLUDED Iva esclusa 22% |
|----------------|-----------------|--------------------------------|--|
| PC | PC H 750 | € 127,00 | € 104,00 |

PC FINISHES / Finiture PC

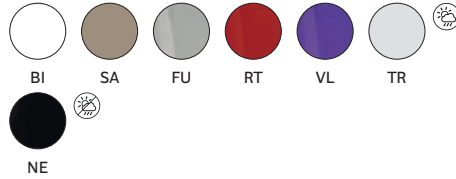

PACKING / Imballo



TECHNICAL DETAILS / Dettagli tecnici

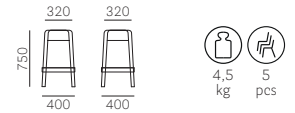

Rubik 582



| SEAT Sedile | FRAME Telaio | POLYCARBONATE Policarbonato | VAT NOT INCLUDED Iva esclusa 22% |
|----------------|-----------------|--------------------------------|--|
| PC | PC H 650 | € 157,50 | € 128,70 |

PC FINISHES / Finiture PC



PACKING / Imballo



TECHNICAL DETAILS / Dettagli tecnici

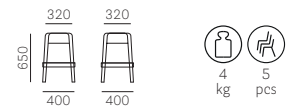

Rubik 583



| SEAT Sedile | FRAME Telaio | POLYCARBONATE Policarbonato | VAT NOT INCLUDED Iva esclusa 22% |
|----------------|-----------------|--------------------------------|--|
| PC | PC H 450 | € 157,50 | € 128,70 |

PC FINISHES / Finiture PC

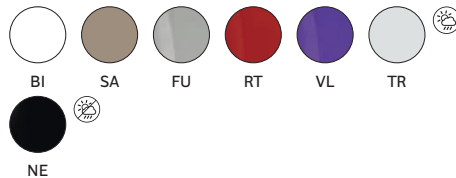

PACKING / Imballo



TECHNICAL DETAILS / Dettagli tecnici



Sign 455



| SEAT Sedile | BACK Schienale | FRAME Telaio | OAK Rovere | VAT NOT INCLUDED Iva esclusa 22% | WALNUT (N) Noce | VAT NOT INCLUDED Iva esclusa 22% |
|----------------|-------------------|-----------------|-----------------|--|--------------------|--|
| G | | | € 514,00 | € 421,20 | € 561,50 | € 460,20 |
| H | RS-W-GC-BI N | RS-W-GC-BI N | € 479,00 | € 392,60 | € 527,00 | € 431,60 |
| P | | | € 521,50 | € 427,05 | € 569,00 | € 466,05 |

For fabrics see page 306
Per i tessuti si veda a p. 306

FINISHES / Finiture

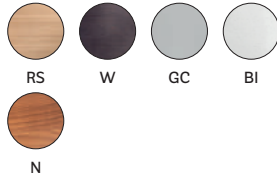

PACKING / Imballo



TECHNICAL DETAILS / Dettagli tecnici

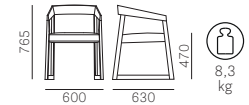

CATAS

Smart 600



| SEAT Sedile | BACK Schienale | FRAME Telaio | NYLON Nylon | VAT NOT INCLUDED Iva esclusa 22% |
|----------------|-------------------|-----------------|-----------------|--|
| NY | NY | NY | € 157,50 | € 128,70 |

NY FINISHES / Finiture NY

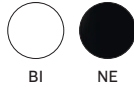

PACKING / Imballo



TECHNICAL DETAILS / Dettagli tecnici



CATAS

Snow 300



| SEAT Sedile | BACK Schienale | FRAME Telaio | POLYPROPYLENE Polipropilene | VAT NOT INCLUDED Iva esclusa 22% |
|----------------|-------------------|-----------------|--------------------------------|--|
| PPL | PPL | PPL | € 81,00 | € 66,30 |

PPL FINISHES / Finiture PPL

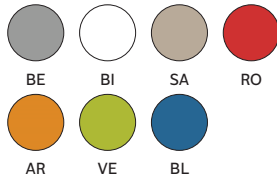

PACKING / Imballo



TECHNICAL DETAILS / Dettagli tecnici



CATAS

Snow 303

JUNIOR



| SEAT Sedile | BACK Schienale | FRAME Telaio | POLYPROPYLENE Polipropilene | VAT NOT INCLUDED Iva esclusa 22% |
|----------------|-------------------|-----------------|--------------------------------|--|
| PPL | PPL | PPL | € 68,50 | € 55,90 |

PPL FINISHES / Finiture PPL



PACKING / Imballo



TECHNICAL DETAILS / Dettagli tecnici

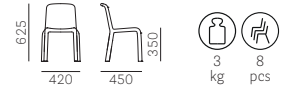

Social

Two seats
Due sedute

| CODE Codice | SEAT Sedile | BACK Schienale | BLACK POWDER COATED Verniciato nero | VAT NOT INCLUDED Iva esclusa 22% | POLISHED ALUMINIUM Alluminio lucidato | VAT NOT INCLUDED Iva esclusa 22% |
|-----------------|---|-------------------|--|--|--|--|
| DSO_2L | C | C | € 1.561,00 | € 1.279,20 | € 1.599,00 | € 1.310,40 |
| | D40÷D44 | D40÷D44 | € 1.676,50 | € 1.374,10 | € 1.714,50 | € 1.405,30 |
| | E | E | € 1.971,50 | € 1.615,90 | € 2.009,50 | € 1.647,10 |
| | G | G | € 1.854,50 | € 1.519,70 | € 1.892,50 | € 1.550,90 |
| | H | H | € 1.602,00 | € 1.313,00 | € 1.640,00 | € 1.344,20 |
| DSO_2LP | N | N | € 1.938,50 | € 1.588,60 | € 1.976,50 | € 1.619,80 |
| | C | C | € 1.410,00 | € 1.155,70 | € 1.450,00 | € 1.188,20 |
| | D40÷D44 | D40÷D44 | € 1.516,50 | € 1.242,80 | € 1.556,00 | € 1.275,30 |
| | E | E | € 1.789,50 | € 1.466,40 | € 1.827,50 | € 1.497,60 |
| | G | G | € 1.680,00 | € 1.376,70 | € 1.718,00 | € 1.407,90 |
| DSO_2AL | H | H | € 1.448,50 | € 1.186,90 | € 1.486,50 | € 1.218,10 |
| | N | N | € 1.756,00 | € 1.439,10 | € 1.795,50 | € 1.471,60 |
| | C | C | € 1.833,50 | € 1.502,80 | € 1.871,50 | € 1.534,00 |
| | D40÷D44 | D40÷D44 | € 1.978,00 | € 1.621,10 | € 2.016,00 | € 1.652,30 |
| | E | E | € 2.341,00 | € 1.918,80 | € 2.379,00 | € 1.950,00 |
| DSO_2A | G | G | € 2.179,50 | € 1.786,20 | € 2.217,50 | € 1.817,40 |
| | H | H | € 1.884,50 | € 1.544,40 | € 1.922,50 | € 1.575,60 |
| | N | N | € 2.304,50 | € 1.888,90 | € 2.343,00 | € 1.920,10 |
| | C | C | € 2.106,50 | € 1.726,40 | € 2.144,50 | € 1.757,60 |
| | D40÷D44 | D40÷D44 | € 2.279,50 | € 1.868,10 | € 2.319,00 | € 1.900,60 |
| DSO_2P | E | E | € 2.710,50 | € 2.221,70 | € 2.749,00 | € 2.252,90 |
| | G | G | € 2.504,50 | € 2.052,70 | € 2.542,50 | € 2.083,90 |
| | H | H | € 2.166,50 | € 1.775,80 | € 2.205,00 | € 1.807,00 |
| | N | N | € 2.671,00 | € 2.189,20 | € 2.710,50 | € 2.221,70 |
| | C | C | € 1.259,50 | € 1.032,20 | € 1.299,00 | € 1.064,70 |
| DSO_2P | D40÷D44 | D40÷D44 | € 1.356,50 | € 1.111,50 | € 1.396,00 | € 1.144,00 |
| | E | E | € 1.607,00 | € 1.316,90 | € 1.645,00 | € 1.348,10 |
| | G | G | € 1.505,50 | € 1.233,70 | € 1.543,50 | € 1.264,90 |
| | H | H | € 1.294,50 | € 1.060,80 | € 1.332,50 | € 1.092,00 |
| | N | N | € 1.573,50 | € 1.289,60 | € 1.613,00 | € 1.322,10 |
| DSO_LINK | Connecting plate kit for DSO sofas: surcharge € 32,00 (€ 26,00 vat not included) Kit lamiera di collegamento per divani DSO: supplemento € 32,00 (€ 26,00 iva esclusa) | | | | | |

For fabrics see page 306
Per i tessuti si veda a p. 306

BS 5852:2006 (Clause 11 Crib 5)

TECHNICAL DETAILS / Dettagli tecnici
DSO_2L

DSO_2LP



DSO_2AL



DSO_2A



DSO_2P



Social

Three seats
Tre sedute

| CODE Codice | SEAT Sedile | BACK Schienale | BLACK POWDER COATED Verniciato nero | VAT NOT INCLUDED Iva esclusa 22% | POLISHED ALUMINIUM Alluminio lucidato | VAT NOT INCLUDED Iva esclusa 22% |
|----------------|---|-------------------|--|--|--|--|
| DSO_3L | C | C | € 2.265,00 | € 1.856,40 | € 2.304,50 | € 1.888,90 |
| | D40÷D44 | D40÷D44 | € 2.439,50 | € 1.999,40 | € 2.477,50 | € 2.030,60 |
| | E | E | € 2.882,00 | € 2.362,10 | € 2.920,00 | € 2.393,30 |
| | G | G | € 2.706,00 | € 2.217,80 | € 2.744,00 | € 2.249,00 |
| | H | H | € 2.327,00 | € 1.907,10 | € 2.365,00 | € 1.938,30 |
| DSO_3LLP | N | N | € 2.831,50 | € 2.320,50 | € 2.869,50 | € 2.351,70 |
| | C | C | € 2.114,50 | € 1.732,90 | € 2.154,00 | € 1.765,40 |
| | D40÷D44 | D40÷D44 | € 2.279,50 | € 1.868,10 | € 2.317,50 | € 1.899,30 |
| | E | E | € 2.699,50 | € 2.212,60 | € 2.737,50 | € 2.243,80 |
| | G | G | € 2.531,50 | € 2.074,80 | € 2.569,50 | € 2.106,00 |
| DSO_3ALL | H | H | € 2.173,00 | € 1.781,00 | € 2.211,00 | € 1.812,20 |
| | N | N | € 2.649,00 | € 2.171,00 | € 2.688,50 | € 2.203,50 |
| | C | C | € 2.538,00 | € 2.080,00 | € 2.576,00 | € 2.111,20 |
| | D40÷D44 | D40÷D44 | € 2.741,00 | € 2.246,40 | € 2.779,00 | € 2.277,60 |
| | E | E | € 3.251,50 | € 2.665,00 | € 3.289,50 | € 2.696,20 |
| DSO_3AAL | G | G | € 3.031,00 | € 2.484,30 | € 3.069,00 | € 2.515,50 |
| | H | H | € 2.609,00 | € 2.138,50 | € 2.647,50 | € 2.169,70 |
| | N | N | € 3.197,50 | € 2.620,80 | € 3.237,50 | € 2.653,30 |
| | C | C | € 2.810,50 | € 2.303,60 | € 2.848,50 | € 2.334,80 |
| | D40÷D44 | D40÷D44 | € 3.042,00 | € 2.493,40 | € 3.080,50 | € 2.524,60 |
| DSO_3P | E | E | € 3.621,00 | € 2.967,90 | € 3.659,00 | € 2.999,10 |
| | G | G | € 3.356,00 | € 2.750,80 | € 3.394,50 | € 2.782,00 |
| | H | H | € 2.891,50 | € 2.369,90 | € 2.929,50 | € 2.401,10 |
| | N | N | € 3.564,00 | € 2.921,10 | € 3.603,50 | € 2.953,60 |
| | C | C | € 1.814,50 | € 1.487,20 | € 1.852,50 | € 1.518,40 |
| DSO_3LINK | D40÷D44 | D40÷D44 | € 1.959,00 | € 1.605,50 | € 1.997,00 | € 1.636,70 |
| | E | E | € 2.335,00 | € 1.913,60 | € 2.373,00 | € 1.944,80 |
| | G | G | € 2.181,00 | € 1.787,50 | € 2.219,00 | € 1.818,70 |
| | H | H | € 1.865,50 | € 1.528,80 | € 1.903,50 | € 1.560,00 |
| | N | N | € 2.285,50 | € 1.873,30 | € 2.323,50 | € 1.904,50 |
| DSO_LINK | Connecting plate kit for DSO sofas: surcharge € 32,00 (€ 26,00 vat not included) Kit lamiera di collegamento per divani DSO: supplemento € 32,00 (€ 26,00 iva esclusa) | | | | | |

For fabrics see page 306
Per i tessuti si veda a p. 306

BS 5852:2006 (Clause 11 Crib 5)

TECHNICAL DETAILS / Dettagli tecnici
DSO_3L

DSO_3LLP



DSO_3ALL

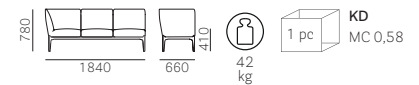

DSO_3AAL

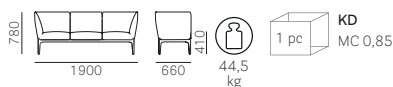

DSO_3P



Social

Four seats
Quattro sedute

| CODE Codice | SEAT Sedile | BACK Schienale | BLACK POWDER COATED Verniciato nero | VAT NOT INCLUDED Iva esclusa 22% | POLISHED ALUMINIUM Alluminio lucidato | VAT NOT INCLUDED Iva esclusa 22% |
|------------------|-----------------|---|--|--|--|--|
| DSO_4L | C | C | € 3.025,00 | € 2.479,10 | € 3.064,50 | € 2.511,60 |
| | D40÷D44 | D40÷D44 | € 3.256,50 | € 2.668,90 | € 3.296,00 | € 2.701,40 |
| | E | E | € 3.846,50 | € 3.152,50 | € 3.886,00 | € 3.185,00 |
| | G | G | € 3.611,50 | € 2.960,10 | € 3.651,00 | € 2.992,60 |
| | H | H | € 3.105,50 | € 2.545,40 | € 3.143,50 | € 2.576,60 |
| DSO_4ALL | N | N | € 3.779,50 | € 3.097,90 | € 3.818,00 | € 3.129,10 |
| | C | C | € 3.297,50 | € 2.702,70 | € 3.335,50 | € 2.733,90 |
| | D40÷D44 | D40÷D44 | € 3.557,50 | € 2.915,90 | € 3.597,50 | € 2.948,40 |
| | E | E | € 4.216,00 | € 3.455,40 | € 4.255,50 | € 3.487,90 |
| | G | G | € 3.936,50 | € 3.226,60 | € 3.975,00 | € 3.257,80 |
| DSO_4AALL | H | H | € 3.388,00 | € 2.776,80 | € 3.427,50 | € 2.809,30 |
| | N | N | € 4.146,00 | € 3.398,20 | € 4.184,00 | € 3.429,40 |
| | C | C | € 3.570,50 | € 2.926,30 | € 3.608,50 | € 2.957,50 |
| | D40÷D44 | D40÷D44 | € 3.859,00 | € 3.162,90 | € 3.898,50 | € 3.195,40 |
| | E | E | € 4.585,50 | € 3.758,30 | € 4.625,00 | € 3.790,80 |
| DSO_2X2P | G | G | € 4.262,00 | € 3.493,10 | € 4.300,00 | € 3.524,30 |
| | H | H | € 3.670,50 | € 3.008,20 | € 3.710,00 | € 3.040,70 |
| | N | N | € 4.512,50 | € 3.698,50 | € 4.550,50 | € 3.729,70 |
| | C | C | € 2.327,00 | € 1.907,10 | € 2.365,00 | € 1.938,30 |
| | D40÷D44 | D40÷D44 | € 2.519,00 | € 2.064,40 | € 2.558,50 | € 2.096,90 |
| DSO_2X2P | E | E | € 3.020,00 | € 2.475,20 | € 3.059,50 | € 2.507,70 |
| | G | G | € 2.815,50 | € 2.307,50 | € 2.855,00 | € 2.340,00 |
| | H | H | € 2.393,50 | € 1.961,70 | € 2.433,00 | € 1.994,20 |
| | N | N | € 2.955,00 | € 2.421,90 | € 2.993,00 | € 2.453,10 |
| | DSO_LINK | Connecting plate kit for DSO sofas: surcharge € 32,00 (€ 26,00 vat not included) Kit lamiera di collegamento per divani DSO: supplemento € 32,00 (€ 26,00 iva esclusa) | | | | |

For fabrics see page 306
Per i tessuti si veda a p. 306

BS 5852:2006 (Clause 11 Crib 5)

TECHNICAL DETAILS / Dettagli tecnici
DSO_4L

DSO_4ALL



DSO_4AALL



DSO_2X2P

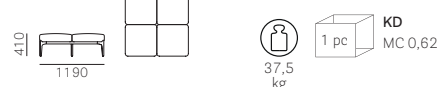

Social corner 45° - 60° - 90° / tablet

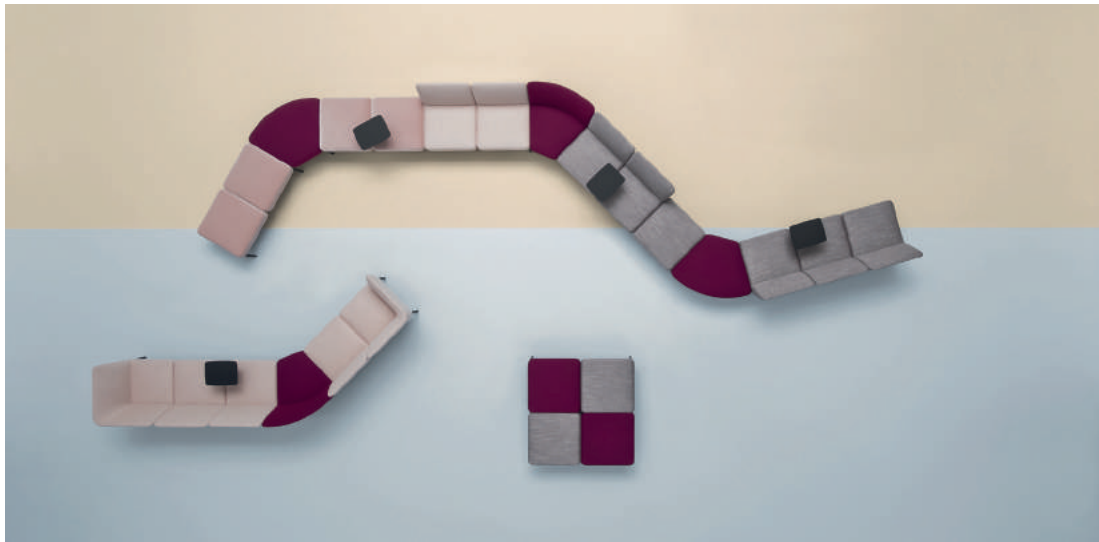

| CODE Codice | SEAT Sedile | BACK Schienale | FABRIC Tessuto | VAT NOT INCLUDED Iva esclusa 22% | BLACK POWDER COATED Verniciato nero | VAT NOT INCLUDED Iva esclusa 22% | POLISHED ALUMINIUM Alluminio lucidato | VAT NOT INCLUDED Iva esclusa 22% |
|--|----------------|-------------------|-------------------|--|---|--|---|--|
| DSO45C Corner 45° with backrest Angolo 45° con schienale | C | C | € 999,50 | € 819,00 | | | | |
| | D40÷D44 | D40÷D44 | € 1.075,50 | € 881,40 | | | | |
| | E | E | € 1.258,00 | € 1.030,90 | | | | |
| | G | G | € 1.191,50 | € 976,30 | | | | |
| | H | H | € 1.026,50 | € 841,10 | | | | |
| N | N | € 1.247,00 | € 1.021,80 | | | | | |
| DSO60P Corner 60° without backrest Angolo 60° senza schienale | C | | € 769,50 | € 630,50 | | | | |
| | D40÷D44 | | € 850,50 | € 696,80 | | | | |
| | E | | € 1.025,00 | € 839,80 | | | | |
| | G | | € 974,00 | € 798,20 | | | | |
| | H | | € 798,00 | € 653,90 | | | | |
| N | | € 1.032,50 | € 846,30 | | | | | |
| DSO90C Corner 90° with backrest Angolo 90° con schienale | C | C | | | € 2.094,00 | € 1.716,00 | € 2.157,00 | € 1.768,00 |
| | D40÷D44 | D40÷D44 | | | € 2.246,00 | € 1.840,80 | € 2.309,50 | € 1.892,80 |
| | E | E | | | € 2.515,50 | € 2.061,80 | € 2.579,00 | € 2.113,80 |
| | G | G | | | € 2.477,50 | € 2.030,60 | € 2.541,00 | € 2.082,60 |
| | H | H | | | € 2.147,50 | € 1.760,20 | € 2.211,00 | € 1.812,20 |
| N | N | | | € 2.588,50 | € 2.121,60 | € 2.652,00 | € 2.173,60 | |

| CODE Codice | TOP Ripiano | VAT NOT INCLUDED Iva esclusa 22% |
|---|---|--|
| DSO/TT Turning tablet Tavoletta girevole | € 206,50 | € 169,00 |
| |  CFP_BI FNP_NE* * Anti-fingerprint finish Finitura anti-impronta | |

For fabrics see page 306
Per i tessuti si veda a p. 306

BS 5852:2006 (Clause 11 Crib 5)

TECHNICAL DETAILS / Dettagli tecnici

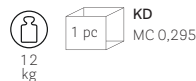
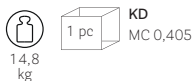

DSO90C

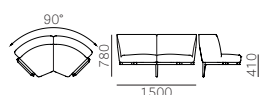

DSO/TT



Social Plus

Two seats
Due sedute

| CODE Codice | SEAT Sedile | BACK Schienale | BLACK POWDER COATED Verniciato nero | VAT NOT INCLUDED Iva esclusa 22% | POLISHED ALUMINIUM Alluminio lucidato | VAT NOT INCLUDED Iva esclusa 22% |
|-----------------|----------------|-------------------|--|--|--|--|
| DSO2_2L | C | C | € 2.195,50 | € 1.799,20 | € 2.293,50 | € 1.879,80 |
| | D40÷D44 | D40÷D44 | € 2.408,00 | € 1.973,40 | € 2.506,00 | € 2.054,00 |
| | E | E | € 2.855,00 | € 2.340,00 | € 2.953,50 | € 2.420,60 |
| | G | G | € 2.733,00 | € 2.239,90 | € 2.831,50 | € 2.320,50 |
| | H | H | € 2.270,00 | € 1.860,30 | € 2.368,00 | € 1.940,90 |
| DSO2_2AL | N | N | € 2.887,00 | € 2.366,00 | € 2.985,00 | € 2.446,60 |
| | C | C | € 2.395,00 | € 1.963,00 | € 2.495,00 | € 2.044,90 |
| | D40÷D44 | D40÷D44 | € 2.603,00 | € 2.133,30 | € 2.701,00 | € 2.213,90 |
| | E | E | € 3.069,00 | € 2.515,50 | € 3.167,50 | € 2.596,10 |
| | G | G | € 2.921,50 | € 2.394,60 | € 3.020,00 | € 2.475,20 |
| DSO2_2A | H | H | € 2.468,00 | € 2.022,80 | € 2.566,50 | € 2.103,40 |
| | N | N | € 3.070,50 | € 2.516,80 | € 3.170,50 | € 2.598,70 |
| | C | C | € 2.596,50 | € 2.128,10 | € 2.695,00 | € 2.208,70 |
| | D40÷D44 | D40÷D44 | € 2.799,50 | € 2.294,50 | € 2.898,00 | € 2.375,10 |
| | E | E | € 3.285,00 | € 2.692,30 | € 3.383,00 | € 2.772,90 |
| DSO2_2A | G | G | € 3.110,50 | € 2.549,30 | € 3.208,50 | € 2.629,90 |
| | H | H | € 2.666,50 | € 2.185,30 | € 2.766,00 | € 2.267,20 |
| | N | N | € 3.256,50 | € 2.668,90 | € 3.354,50 | € 2.749,50 |

| CODE Codice | | FABRIC Tessuto | VAT NOT INCLUDED Iva esclusa 22% |
|--|---|-------------------|--|
|  DSO2.3 Cushion only Solo cuscino | C | € 103,50 | € 84,50 |
| | D40÷D44 | € 122,50 | € 100,10 |
| | E | € 151,00 | € 123,50 |
| | G | € 151,00 | € 123,50 |
| | H | € 109,50 | € 89,70 |
| DSO_LINK | N | € 165,00 | € 135,20 |
| | Connecting plate kit for DSO sofas: surcharge € 32,00 (€ 26,00 vat not included) Kit lamiera di collegamento per divani DSO: supplemento € 32,00 (€ 26,00 iva esclusa) | | |

For fabrics see page 306
Per i tessuti si veda a p. 306

TECHNICAL DETAILS / Dettagli tecnici

DSO2_2L



DSO2_2AL

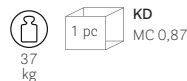
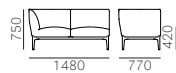

DSO2_2A

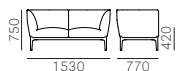

DSO2.3



Social Plus

Three seats
Tre sedute

| CODE Codice | SEAT Sedile | BACK Schienale | BLACK POWDER COATED Verniciato nero | VAT NOT INCLUDED Iva esclusa 22% | POLISHED ALUMINIUM Alluminio lucidato | VAT NOT INCLUDED Iva esclusa 22% |
|------------------|----------------|-------------------|--|--|--|--|
| DSO2_3L | C | C | € 3.186,50 | € 2.611,70 | € 3.294,50 | € 2.700,10 |
| | D40÷D44 | D40÷D44 | € 3.505,50 | € 2.873,00 | € 3.611,50 | € 2.960,10 |
| | E | E | € 4.178,00 | € 3.424,20 | € 4.284,00 | € 3.511,30 |
| | G | G | € 3.994,00 | € 3.273,40 | € 4.100,00 | € 3.360,50 |
| | H | H | € 3.297,50 | € 2.702,70 | € 3.405,50 | € 2.791,10 |
| DSO2_3ALL | N | N | € 4.224,00 | € 3.461,90 | € 4.330,00 | € 3.549,00 |
| | C | C | € 3.388,00 | € 2.776,80 | € 3.494,00 | € 2.863,90 |
| | D40÷D44 | D40÷D44 | € 3.702,00 | € 3.034,20 | € 3.808,00 | € 3.121,30 |
| | E | E | € 4.392,00 | € 3.599,70 | € 4.498,00 | € 3.686,80 |
| | G | G | € 4.182,50 | € 3.428,10 | € 4.289,00 | € 3.515,20 |
| DSO2_3AAL | H | H | € 3.497,50 | € 2.866,50 | € 3.603,50 | € 2.953,60 |
| | N | N | € 4.409,50 | € 3.614,00 | € 4.515,50 | € 3.701,10 |
| | C | C | € 3.588,00 | € 2.940,60 | € 3.694,00 | € 3.027,70 |
| | D40÷D44 | D40÷D44 | € 3.897,00 | € 3.194,10 | € 4.003,50 | € 3.281,20 |
| | E | E | € 4.607,50 | € 3.776,50 | € 4.714,00 | € 3.863,60 |
| DSO2_3AAL | G | G | € 4.371,50 | € 3.582,80 | € 4.477,50 | € 3.669,90 |
| | H | H | € 3.695,50 | € 3.029,00 | € 3.802,00 | € 3.116,10 |
| | N | N | € 4.593,50 | € 3.764,80 | € 4.699,50 | € 3.851,90 |

| CODE Codice | FABRIC Tessuto | VAT NOT INCLUDED Iva esclusa 22% |
|--|---|--|
|  DSO2.3 Cushion only Solo cuscino | C | € 103,50 |
| | D40÷D44 | € 122,50 |
| | E | € 151,00 |
| | G | € 151,00 |
| | H | € 109,50 |
| DSO_LINK | N | € 165,00 |
| | Connecting plate kit for DSO sofas: surcharge € 32,00 (€ 26,00 vat not included) Kit lamiera di collegamento per divani DSO: supplemento € 32,00 (€ 26,00 iva esclusa) | |

For fabrics see page 306
Per i tessuti si veda a p. 306

TECHNICAL DETAILS / Dettagli tecnici

DSO2_3L

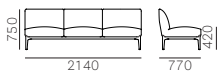

DSO2_3ALL

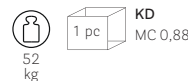
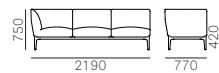

DSO2_3AAL

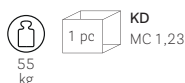
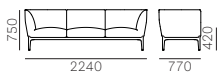

DSO2.3



Social Plus

Four seats
Quattro sedute

| CODE Codice | SEAT Sedile | BACK Schienale | BLACK POWDER COATED Verniciato nero | VAT NOT INCLUDED Iva esclusa 22% | POLISHED ALUMINIUM Alluminio lucidato | VAT NOT INCLUDED Iva esclusa 22% |
|-------------------|----------------|-------------------|--|--|--|--|
| DSO2_4L | C | C | € 4.276,00 | € 3.504,80 | € 4.393,50 | € 3.601,00 |
| | D40÷D44 | D40÷D44 | € 4.701,00 | € 3.853,20 | € 4.817,00 | € 3.948,10 |
| | E | E | € 5.595,50 | € 4.586,40 | € 5.713,00 | € 4.682,60 |
| | G | G | € 5.353,00 | € 4.387,50 | € 5.469,00 | € 4.482,40 |
| | H | H | € 4.425,00 | € 3.627,00 | € 4.541,00 | € 3.721,90 |
| DSO2_4ALL | N | N | € 5.659,00 | € 4.638,40 | € 5.775,00 | € 4.733,30 |
| | C | C | € 4.477,50 | € 3.669,90 | € 4.593,50 | € 3.764,80 |
| | D40÷D44 | D40÷D44 | € 4.898,00 | € 4.014,40 | € 5.013,50 | € 4.109,30 |
| | E | E | € 5.811,50 | € 4.763,20 | € 5.927,00 | € 4.858,10 |
| | G | G | € 5.541,50 | € 4.542,20 | € 5.657,50 | € 4.637,10 |
| DSO2_4AALL | H | H | € 4.623,50 | € 3.789,50 | € 4.739,00 | € 3.884,40 |
| | N | N | € 5.844,50 | € 4.790,50 | € 5.960,50 | € 4.885,40 |
| | C | C | € 4.677,50 | € 3.833,70 | € 4.793,00 | € 3.928,60 |
| | D40÷D44 | D40÷D44 | € 5.093,00 | € 4.174,30 | € 5.208,50 | € 4.269,20 |
| | E | E | € 6.025,50 | € 4.938,70 | € 6.143,00 | € 5.034,90 |
| DSO2_4AALL | G | G | € 5.729,00 | € 4.695,60 | € 5.844,50 | € 4.790,50 |
| | H | H | € 4.821,50 | € 3.952,00 | € 4.939,00 | € 4.048,20 |
| | N | N | € 6.028,50 | € 4.941,30 | € 6.144,50 | € 5.036,20 |

| CODE Codice | FABRIC Tessuto | VAT NOT INCLUDED Iva esclusa 22% |
|--|---|--|
|  DSO2.3 Cushion only Solo cuscino | C | € 103,50 |
| | D40÷D44 | € 122,50 |
| | E | € 151,00 |
| | G | € 151,00 |
| | H | € 109,50 |
| DSO_LINK | N | € 165,00 |
| | Connecting plate kit for DSO sofas: surcharge € 32,00 (€ 26,00 vat not included) Kit lamiera di collegamento per divani DSO: supplemento € 32,00 (€ 26,00 iva esclusa) | |

For fabrics see page 306
Per i tessuti si veda a p. 306

TECHNICAL DETAILS / Dettagli tecnici

DSO2_4L



DSO2_4ALL

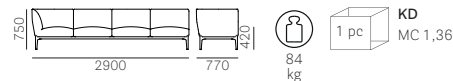

DSO2_4AALL



DSO2.3



Soul 3745



| SEAT Sedile | BACK Schienale | FRAME Telaio | BLEACHED ASH Frassino sbiancato | BLACK LACQUERED ASH Frassino laccato nero | ASH STAINED WALNUT Frassino tinto noce | VAT NOT INCLUDED Iva esclusa 22% |
|----------------|-------------------|-----------------|------------------------------------|--|---|--|
| | FR | FR | € 698,00 (TR, BI) | | | |
| PC | N2 | N2 | | | € 698,00 (TR, BI, FU) | € 572,00 |
| | AN | AN | | € 698,00 (NE, FU) | | |

PC FINISHES / Finiture PC

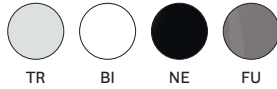

WOODEN FINISHES / Finiture legno



TECHNICAL DETAILS / Dettagli tecnici



Soul 3746

OUTDOOR



| SEAT Sedile | BACK Schienale | FRAME Telaio | POWDER COATED Verniciato | POLISHED ALUMINIUM Alluminio lucidato | ANODIZED ALUMINIUM Alluminio anodizzato | VAT NOT INCLUDED Iva esclusa 22% |
|----------------|-------------------|-----------------|-----------------------------|--|--|--|
| | | | € 460,00 | | | € 377,00 |
| TEAK | METAL Ø 30 | METAL Ø 30 | | € 619,00 | | € 507,00 |
| | | | | | € 619,00 | € 507,00 |

FINISHES / Finiture

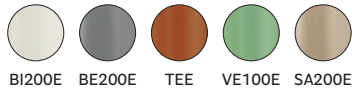

PACKING / Imballo



TECHNICAL DETAILS / Dettagli tecnici



Sunset 625



| SEAT Sedile | BACK Schienale | FRAME Telaio | POLYETHYLENE Polietilene | VAT NOT INCLUDED Iva esclusa 22% |
|----------------|-------------------|-----------------|-----------------------------|--|
| PET | PET | PET | € 492,00 | € 403,00 |

PET FINISHES / Finiture PET



PACKING / Imballo



TECHNICAL DETAILS / Dettagli tecnici

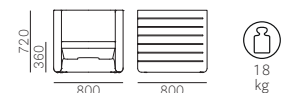

Sunset 625.10

Seat + back cushion
Cuscino per sedile e schienale



| SEAT Sedile | BACK Schienale | FABRIC Tessuto | VAT NOT INCLUDED Iva esclusa 22% |
|----------------|-------------------|-------------------|--|
| D31+D39 | D31+D39 | € 444,50 | € 364,00 |

We suggest to remove the cushions over night and in rainy days
Si consiglia di ritirare i cuscini durante la notte e in caso di pioggia

FINISHES / Finiture

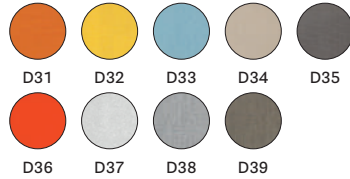

PACKING / Imballo



TECHNICAL DETAILS / Dettagli tecnici

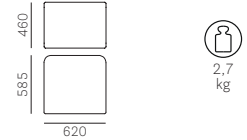

Sunset 625.3

Seat cushion
Cuscino per sedile



| SEAT Sedile | FABRIC Tessuto | VAT NOT INCLUDED Iva esclusa 22% |
|----------------|-------------------|--|
| D31+D39 | € 238,00 | € 195,00 |

We suggest to remove the cushions over night and in rainy days
Si consiglia di ritirare i cuscini durante la notte e in caso di pioggia

FINISHES / Finiture



PACKING / Imballo



TECHNICAL DETAILS / Dettagli tecnici

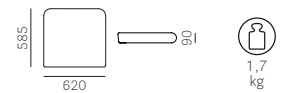

Sunset 626

SOFA



| SEAT Sedile | BACK Schienale | FRAME Telaio | POLYETHYLENE Polietilene | VAT NOT INCLUDED Iva esclusa 22% |
|----------------|-------------------|-----------------|-----------------------------|--|
| PET | PET | PET | € 999,50 | € 819,00 |

PET FINISHES / Finiture PET



PACKING / Imballo



TECHNICAL DETAILS / Dettagli tecnici

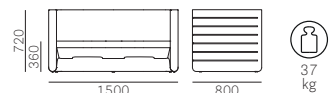

Sunset 626.10

Seat + back cushion
Cuscino per sedile e schienale



| SEAT Sedile | BACK Schienale | FABRIC Tessuto | VAT NOT INCLUDED Iva esclusa 22% |
|----------------|-------------------|-------------------|--|
| D31+D39 | D31+D39 | € 730,00 | € 598,00 |

We suggest to remove the cushions over night and in rainy days
Si consiglia di ritirare i cuscini durante la notte e in caso di pioggia

FINISHES / Finiture

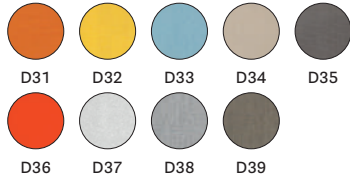

PACKING / Imballo



TECHNICAL DETAILS / Dettagli tecnici

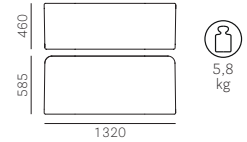

Sunset 626.3

Seat cushion
Cuscino per sedile



| SEAT Sedile | FABRIC Tessuto | VAT NOT INCLUDED Iva esclusa 22% |
|----------------|-------------------|--|
| D31+D39 | € 396,50 | € 325,00 |

We suggest to remove the cushions over night and in rainy days
Si consiglia di ritirare i cuscini durante la notte e in caso di pioggia

FINISHES / Finiture

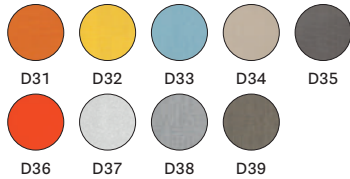

PACKING / Imballo



TECHNICAL DETAILS / Dettagli tecnici

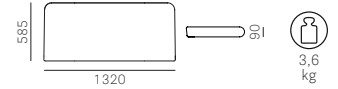

Sunset 625.20

Supporting plane
Piano d'appoggio



| TOP Ripiano | FRAME Telaio | SOLID LAMINATE Stratificato | VAT NOT INCLUDED Iva esclusa 22% |
|----------------|-----------------|--------------------------------------|--|
| CFP_BI | BI100E | € 114,50 For Sunset BI, SA | € 93,60 |
| COP_234 | BE200E | € 114,50 For Sunset BE | € 93,60 |

FINISHES / Finiture

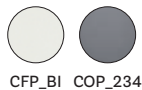

PACKING / Imballo



TECHNICAL DETAILS / Dettagli tecnici

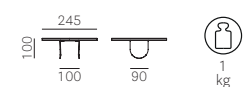

Sunset 625.30

Double supporting plane
Doppio piano d'appoggio



| TOP Ripiano | FRAME Telaio | SOLID LAMINATE Stratificato | VAT NOT INCLUDED Iva esclusa 22% |
|----------------|-----------------|--------------------------------------|--|
| CFP_BI | BI100E | € 117,50 For Sunset BI, SA | € 96,20 |
| COP_234 | BE200E | € 117,50 For Sunset BE | € 96,20 |

FINISHES / Finiture



CFP_BI COP_234

PACKING / Imballo



TECHNICAL DETAILS / Dettagli tecnici

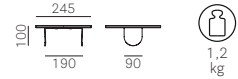

Tatami 305



| SEAT Sedile | BACK Schienale | FRAME Telaio | POLYPROPYLENE Polipropilene | VAT NOT INCLUDED Iva esclusa 22% |
|----------------|-------------------|-----------------|--------------------------------|--|
| PPL | PPL | PPL | € 81,00 | € 66,30 |

PPL FINISHES / Finiture PPL



BI VE GA RO MA SA

PACKING / Imballo



TECHNICAL DETAILS / Dettagli tecnici

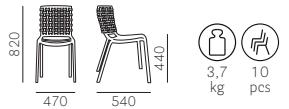

Tatami 306



| SEAT Sedile | BACK Schienale | FRAME Telaio | POLYPROPYLENE Polipropilene | VAT NOT INCLUDED Iva esclusa 22% |
|----------------|-------------------|-----------------|--------------------------------|--|
| PPL | PPL | PPL | € 106,50 | € 87,10 |

PPL FINISHES / Finiture PPL



BI VE GA RO MA SA

PACKING / Imballo



TECHNICAL DETAILS / Dettagli tecnici

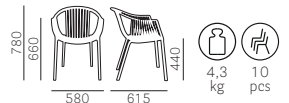

CATAS



PRODUCT CERTIFIED
FOR LOW CHEMICAL
EMISSIONS:
UL.COM/GG
UL 2818

Temps 3765



| SEAT Sedile | BACK Schienale | FRAME Telaio | WHITE/BLACK POWDER COATED Verniciato bianco/nero | VAT NOT INCLUDED Iva esclusa 22% | POLISHED ALUMINIUM Alluminio lucidato | VAT NOT INCLUDED Iva esclusa 22% |
|-----------------------|-----------------------|-----------------|--|--|---|--|
| C83+C101 | C83+C101 | | € 833,00 | € 682,50 | € 888,50* | € 728,00* |
| G59+G197 G170+G176 | G59+G197 G170+G176 | Ø 750 | € 964,50 | € 790,40 | € 1.020,00* | € 835,90* |
| H60+H64 | H60+H64 | | € 850,50 | € 696,80 | € 906,00* | € 742,30* |

*Armrest finish: black only
Finitura bracciolo: solo nero

PPL FINISHES / Finiture PPL

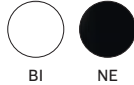

For fabrics see page 306
Per i tessuti si veda a p. 306

PACKING / Imballo



TECHNICAL DETAILS / Dettagli tecnici



CATAS

Tivoli 2800



| SEAT Sedile | BACK Schienale | FRAME Telaio | ASH Frassino | VAT NOT INCLUDED Iva esclusa 22% |
|--------------------|--------------------|--------------------|-----------------|--|
| FR-N1-AN- GC-BI | FR-N1-AN- GC-BI | FR-N1-AN- GC-BI | € 515,50 | € 422,50 |

FINISHES / Finiture



PACKING / Imballo



TECHNICAL DETAILS / Dettagli tecnici

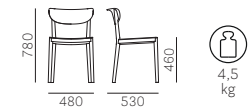

CATAS

Tivoli 2801



| SEAT Sedile | BACK Schienale | FRAME Telaio | ASH Frassino | VAT NOT INCLUDED Iva esclusa 22% |
|----------------|-------------------|--------------------|-----------------|--|
| G | G | | € 691,50 | € 566,80 |
| H | H | FR-N1-AN- GC-BI | € 623,50 | € 510,90 |
| P | P | | € 717,00 | € 587,60 |

For fabrics see page 306
Per i tessuti si veda a p. 306

FINISHES / Finiture



PACKING / Imballo



TECHNICAL DETAILS / Dettagli tecnici

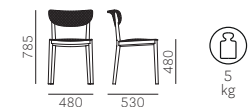

CATAS

Tivoli 2802



| SEAT Sedile | BACK Schienale | FRAME Telaio | ASH Frassino | VAT NOT INCLUDED Iva esclusa 22% |
|----------------|--------------------|--------------------|-----------------|--|
| G | | | € 603,50 | € 494,65 |
| H | FR-N1-AN- GC-BI | FR-N1-AN- GC-BI | € 569,50 | € 466,70 |
| P | | | € 616,50 | € 505,05 |

For fabrics see page 306
Per i tessuti si veda a p. 306

FINISHES / Finiture



PACKING / Imballo



TECHNICAL DETAILS / Dettagli tecnici



CATAS

Tivoli 2805



| SEAT Sedile | BACK Schienale | FRAME Telaio | ASH Frassino | VAT NOT INCLUDED Iva esclusa 22% |
|--------------------|--------------------|--------------------|-----------------|--|
| FR-N1-AN- GC-BI | FR-N1-AN- GC-BI | FR-N1-AN- GC-BI | € 595,00 | € 487,50 |

FINISHES / Finiture



PACKING / Imballo



TECHNICAL DETAILS / Dettagli tecnici

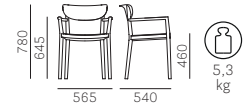

CATAS

Tivoli 2806



| SEAT Sedile | BACK Schienale | FRAME Telaio | ASH Frassino | VAT NOT INCLUDED Iva esclusa 22% |
|----------------|-------------------|--------------------|-----------------|--|
| G | G | | € 794,00 | € 650,65 |
| H | H | FR-N1-AN- GC-BI | € 719,50 | € 589,55 |
| P | P | | € 822,50 | € 674,05 |

For fabrics see page 306
Per i tessuti si veda a p. 306

FINISHES / Finiture



PACKING / Imballo



TECHNICAL DETAILS / Dettagli tecnici

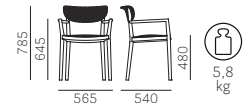

CATAS

Tivoli 2807



| SEAT Sedile | BACK Schienale | FRAME Telaio | ASH Frassino | VAT NOT INCLUDED Iva esclusa 22% |
|----------------|--------------------|--------------------|-----------------|--|
| G | | | € 695,00 | € 569,40 |
| H | FR-N1-AN- GC-BI | FR-N1-AN- GC-BI | € 657,50 | € 538,85 |
| P | | | € 709,00 | € 581,10 |

For fabrics see page 306
Per i tessuti si veda a p. 306

FINISHES / Finiture



PACKING / Imballo



TECHNICAL DETAILS / Dettagli tecnici



CATAS

Trend 448



| SEAT Sedile | BACK Schienale | FRAME Telaio | CHROMED Cromato | VAT NOT INCLUDED Iva esclusa 22% |
|----------------|-------------------|-----------------|--------------------|--|
| F11+F19 | F11+F19 | Ø 10 | € 198,50 | € 162,50 |

REGENERATED LEATHER FINISHES / Finiture cuoio rigenerato



PACKING / Imballo



TECHNICAL DETAILS / Dettagli tecnici

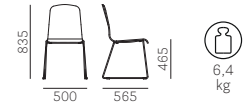

Tribeca 3660



| SEAT Sedile | BACK Schienale | FRAME Telaio | POWDER COATED Verniciato | VAT NOT INCLUDED Iva esclusa 22% |
|----------------|-------------------|-----------------|-----------------------------|--|
| PVC | PVC | METAL Ø 20 | € 311,00 | € 254,80 |

*Flexible PVC profile in the same colour of the frame. Only for BI200 colour frame, PVC profile is in beige colour
Intreccio in PVC flessibile in tinta con il telaio. Solo per il colore del telaio BI200, l'intreccio in PVC è color beige

FINISHES / Finiture



PACKING / Imballo



TECHNICAL DETAILS / Dettagli tecnici



CATAS

Tribeca 3665



| SEAT Sedile | BACK Schienale | FRAME Telaio | POWDER COATED Verniciato | VAT NOT INCLUDED Iva esclusa 22% |
|----------------|-------------------|-----------------|-----------------------------|--|
| PVC | PVC | METAL Ø 20 | € 341,00 | € 279,50 |

*Flexible PVC profile in the same colour of the frame. Only for BI200 colour frame, PVC profile is in beige colour
Intreccio in PVC flessibile in tinta con il telaio. Solo per il colore del telaio BI200, l'intreccio in PVC è color beige

FINISHES / Finiture



BI200E* TEE VE100E MGE



RA100E RO400E BL300E

PACKING / Imballo



2 pcs MC 0,35

TECHNICAL DETAILS / Dettagli tecnici



Tribeca 3667



| SEAT Sedile | BACK Schienale | FRAME Telaio | POWDER COATED Verniciato | VAT NOT INCLUDED Iva esclusa 22% |
|----------------|-------------------|-----------------------|-----------------------------|--|
| PVC | PVC | METAL Ø 20 H675 | € 330,00 | € 270,40 |

*Flexible PVC profile in the same colour of the frame. Only for BI200 colour frame, PVC profile is in beige colour
Intreccio in PVC flessibile in tinta con il telaio. Solo per il colore del telaio BI200, l'intreccio in PVC è color beige

FINISHES / Finiture



BI200E* TEE VE100E MGE



RA100E RO400E BL300E

PACKING / Imballo



2 pcs MC 0,30

TECHNICAL DETAILS / Dettagli tecnici



Tribeca 3668



| SEAT Sedile | BACK Schienale | FRAME Telaio | POWDER COATED Verniciato | VAT NOT INCLUDED Iva esclusa 22% |
|----------------|-------------------|-----------------------|-----------------------------|--|
| PVC | PVC | METAL Ø 20 H775 | € 339,50 | € 278,20 |

*Flexible PVC profile in the same colour of the frame. Only for BI200 colour frame, PVC profile is in beige colour
Intreccio in PVC flessibile in tinta con il telaio. Solo per il colore del telaio BI200, l'intreccio in PVC è color beige

FINISHES / Finiture



BI200E* TEE VE100E MGE



RA100E RO400E BL300E

PACKING / Imballo



2 pcs MC 0,30

TECHNICAL DETAILS / Dettagli tecnici



Tribeca 3669

LOUNGE



| SEAT Sedile | BACK Schienale | FRAME Telaio | POWDER COATED Verniciato | VAT NOT INCLUDED Iva esclusa 22% |
|----------------|-------------------|-----------------|-----------------------------|--|
| PVC | PVC | METAL Ø 20 | € 412,50 | € 338,00 |

*Flexible PVC profile in the same colour of the frame. Only for BI200 colour frame, PVC profile is in beige colour
Intreccio in PVC flessibile in tinta con il telaio. Solo per il colore del telaio BI200, l'intreccio in PVC è color beige

FINISHES / Finiture



BI200E* TEE VE100E MGE



RA100E RO400E BL300E

PACKING / Imballo



TECHNICAL DETAILS / Dettagli tecnici

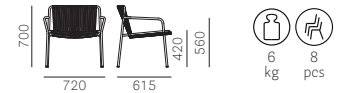

Tribeca 3666

SOFA LOUNGE

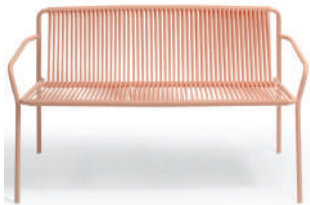

| SEAT Sedile | BACK Schienale | FRAME Telaio | POWDER COATED Verniciato | VAT NOT INCLUDED Iva esclusa 22% |
|----------------|-------------------|-----------------|-----------------------------|--|
| PVC | PVC | METAL Ø 20 | € 841,00 | € 689,00 |

*Flexible PVC profile in the same colour of the frame. Only for BI200 colour frame, PVC profile is in beige colour
Intreccio in PVC flessibile in tinta con il telaio. Solo per il colore del telaio BI200, l'intreccio in PVC è color beige

FINISHES / Finiture



BI200E* TEE VE100E MGE



RA100E RO400E BL300E

PACKING / Imballo



TECHNICAL DETAILS / Dettagli tecnici



Tweet 890

One-colour
Monocolore



| SEAT Sedile | BACK Schienale | FRAME Telaio | WHITE/BLACK/BEIGE POWDER COATED Verniciato bianco/nero/beige | CHROMED Cromato | BLACK CHROMED Cromato nero | VAT NOT INCLUDED Iva esclusa 22% |
|----------------|-------------------|-----------------|--|--------------------|-------------------------------|--|
| PPL | PPL | Ø 14 | € 136,50 | € 136,50 | | € 111,80 |
| | | | | | € 165,00 | € 135,20 |

PPL FINISHES / Finiture PPL



BI NE BE AR

PACKING / Imballo



TECHNICAL DETAILS / Dettagli tecnici



CATAS

Tweet 890

Bicolour
Bicolore



| SEAT Sedile | BACK Schienale | FRAME Telaio | POWDER COATED Verniciato | CHROMED Cromato | BLACK CHROMED Cromato nero | VAT NOT INCLUDED Iva esclusa 22% |
|----------------|-------------------|-----------------|---|--------------------|-------------------------------|--|
| PPL | PPL | Ø 14 | <p>€ 136,50</p> <p>Frame in the same colour of shell, GI frame finish excluded Telaio in tinta con la scocca, escluso telaio finitura GI</p> | € 136,50 | | € 111,80 |
| | | | | | € 165,00 | € 135,20 |

White front side always
Scocca interna sempre bianca

PPL FINISHES / Finiture PPL

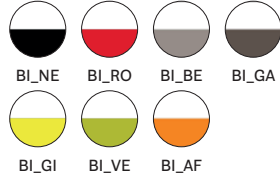

PACKING / Imballo



TECHNICAL DETAILS / Dettagli tecnici



CATAS

Tweet 897

One-colour
Monocolore



| SEAT Sedile | BACK Schienale | FRAME Telaio | WHITE/BLACK/BEIGE POWDER COATED Verniciato bianco/nero/beige | CHROMED Cromato | VAT NOT INCLUDED Iva esclusa 22% |
|----------------|-------------------|-----------------|--|--------------------|--|
| PPL | PPL | Ø 11 | € 152,50 | € 152,50 | € 124,80 |

PPL FINISHES / Finiture PPL

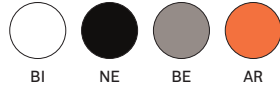

PACKING / Imballo



TECHNICAL DETAILS / Dettagli tecnici



CATAS

Tweet 897

Bicolour
Bicolore



| SEAT Sedile | BACK Schienale | FRAME Telaio | POWDER COATED Verniciato | CHROMED Cromato | VAT NOT INCLUDED Iva esclusa 22% |
|----------------|-------------------|-----------------|---|--------------------|--|
| PPL | PPL | Ø 11 | <p>€ 152,50</p> <p>Frame in the same colour of shell, GI frame finish excluded Telaio in tinta con la scocca, escluso telaio finitura GI</p> | € 152,50 | € 124,80 |

White front side always
Scocca interna sempre bianca

PPL FINISHES / Finiture PPL

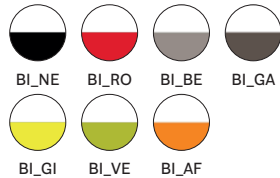

PACKING / Imballo



TECHNICAL DETAILS / Dettagli tecnici



CATAS

Tweet 893

One-colour
Monocolore



| SEAT Sedile | BACK Schienale | FRAME Telaio | BLACK POWDER COATED Verniciato nero | VAT NOT INCLUDED Iva esclusa 22% |
|----------------|-------------------|-----------------|--|--|
| PPL | PPL | Ø 680 | € 255,50 | € 209,30 |

PPL FINISHES / Finiture PPL

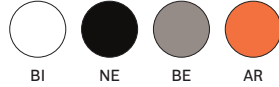

PACKING / Imballo



TECHNICAL DETAILS / Dettagli tecnici



CATAS

Tweet 893

Bicolour
Bicolore



| SEAT Sedile | BACK Schienale | FRAME Telaio | BLACK POWDER COATED Verniciato nero | VAT NOT INCLUDED Iva esclusa 22% |
|----------------|-------------------|-----------------|--|--|
| PPL | PPL | Ø 680 | € 255,50 | € 209,30 |

White front side always
Scocca interna sempre bianca

PPL FINISHES / Finiture PPL

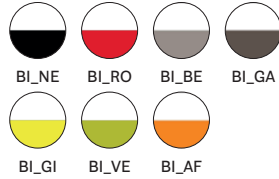

PACKING / Imballo



TECHNICAL DETAILS / Dettagli tecnici



CATAS

Tweet 893F

One-colour
Monocolore



| SEAT Sedile | BACK Schienale | FRAME Telaio | BLACK POWDER COATED Verniciato nero | VAT NOT INCLUDED Iva esclusa 22% |
|----------------|-------------------|-----------------|--|--|
| PPL | PPL | Ø 680 | € 287,50 | € 235,30 |

PPL FINISHES / Finiture PPL

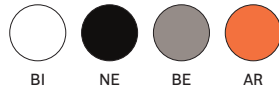

PACKING / Imballo



TECHNICAL DETAILS / Dettagli tecnici



Tweet 893F

Bicolour
Bicolore



| SEAT Sedile | BACK Schienale | FRAME Telaio | BLACK POWDER COATED Verniciato nero | VAT NOT INCLUDED Iva esclusa 22% |
|----------------|-------------------|-----------------|--|--|
| PPL | PPL | Ø 680 | € 287,50 | € 235,30 |

White front side always
Scocca interna sempre bianca

PPL FINISHES / Finiture PPL



BI_NE BI_RO BI_BE BI_GA



BI_GI BI_VE BI_AF

PACKING / Imballo



TECHNICAL DETAILS / Dettagli tecnici



Tweet 891

Gas lift device
Alzata a gas



| SEAT Sedile | BACK Schienale | FRAME Telaio | BLACK POWDER COATED Verniciato nero | VAT NOT INCLUDED Iva esclusa 22% |
|----------------|-------------------|-----------------|--|--|
| PPL | PPL | Ø 650 | € 317,50 | € 260,00 |

White front side always
Scocca interna sempre bianca

PPL FINISH / Finitura PPL



BI_NE

PACKING / Imballo



TECHNICAL DETAILS / Dettagli tecnici



Tweet 890/2

SOFT



| SEAT Sedile | BACK Schienale | FRAME Telaio | WHITE/BLACK POWDER COATED Verniciato bianco/nero | CHROMED Cromato | VAT NOT INCLUDED Iva esclusa 22% | ANTIQU BRASS Ottone anticato | VAT NOT INCLUDED Iva esclusa 22% |
|----------------|-------------------|-----------------|--|--------------------|--|---------------------------------|--|
| C | C | Ø 14 | € 390,50 | € 390,50 | € 319,80 | € 485,50 | € 397,80 |
| E | E | | € 533,00 | € 533,00 | € 436,80 | € 628,50 | € 514,80 |
| G | G | | € 533,00 | € 533,00 | € 436,80 | € 628,50 | € 514,80 |
| H | H | | € 409,50 | € 409,50 | € 335,40 | € 504,50 | € 413,40 |

For fabrics see page 306
Per i tessuti si veda a p. 306

PACKING / Imballo



TECHNICAL DETAILS / Dettagli tecnici



Tweet 897/2

SOFT



| SEAT Sedile | BACK Schienale | FRAME Telaio | WHITE/BLACK POWDER COATED Verniciato bianco/nero | CHROMED Cromato | VAT NOT INCLUDED Iva esclusa 22% | ANTIQUÉ BRASS Ottone anticato | VAT NOT INCLUDED Iva esclusa 22% |
|----------------|-------------------|-----------------|--|--------------------|--|----------------------------------|--|
| C | C | Ø 11 | € 406,50 | € 406,50 | € 332,80 | € 501,50 | € 410,80 |
| E | E | | € 549,00 | € 549,00 | € 449,80 | € 644,00 | € 527,80 |
| G | G | | € 549,00 | € 549,00 | € 449,80 | € 644,00 | € 527,80 |
| H | H | | € 425,50 | € 425,50 | € 348,40 | € 520,50 | € 426,40 |

For fabrics see page 306
Per i tessuti si veda a p. 306

PACKING / Imballo



TECHNICAL DETAILS / Dettagli tecnici



Tweet 893/2

SOFT



| SEAT Sedile | BACK Schienale | FRAME Telaio | WHITE/BLACK POWDER COATED Verniciato bianco/nero | VAT NOT INCLUDED Iva esclusa 22% |
|----------------|-------------------|-----------------|---|--|
| C | C | Ø 680 | € 509,50 | € 417,30 |
| E | E | | € 652,00 | € 534,30 |
| G | G | | € 652,00 | € 534,30 |
| H | H | | € 528,50 | € 432,90 |

For fabrics see page 306
Per i tessuti si veda a p. 306

PACKING / Imballo



TECHNICAL DETAILS / Dettagli tecnici



Tweet 893F/2

SOFT



| SEAT Sedile | BACK Schienale | FRAME Telaio | WHITE/BLACK POWDER COATED Verniciato bianco/nero | VAT NOT INCLUDED Iva esclusa 22% |
|----------------|-------------------|-----------------|---|--|
| C | C | Ø 680 | € 541,00 | € 443,30 |
| E | E | | € 684,00 | € 560,30 |
| G | G | | € 684,00 | € 560,30 |
| H | H | | € 560,00 | € 458,90 |

For fabrics see page 306
Per i tessuti si veda a p. 306

PACKING / Imballo



TECHNICAL DETAILS / Dettagli tecnici



Tweet 891/2

SOFT
Gas lift device
Alzata a gas



| SEAT Sedile | BACK Schienale | FRAME Telaio | BLACK POWDER COATED Verniciato nero | VAT NOT INCLUDED Iva esclusa 22% |
|----------------|-------------------|-----------------|--|--|
| C | C | Ø 650 | € 571,00 | € 468,00 |
| E | E | | € 714,00 | € 585,00 |
| G | G | | € 714,00 | € 585,00 |
| H | H | | € 590,00 | € 483,60 |

For fabrics see page 306
Per i tessuti si veda a p. 306

PACKING / Imballo



TECHNICAL DETAILS / Dettagli tecnici



Tweet 895

One-colour
Monocolore



| SEAT Sedile | BACK Schienale | FRAME Telaio | WHITE/BLACK/BEIGE POWDER COATED Verniciato bianco/nero/beige | CHROMED Cromato | BLACK CHROMED Cromato nero | VAT NOT INCLUDED Iva esclusa 22% |
|----------------|-------------------|-----------------|--|--------------------|-------------------------------|--|
| PPL | PPL | Ø 14 | € 239,50 | € 239,50 | € 196,30 | € 219,70 |
| | | | | | € 268,50 | |

PPL FINISHES / Finiture PPL

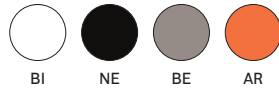

PACKING / Imballo



TECHNICAL DETAILS / Dettagli tecnici



Tweet 895

Bicolour
Bicolore



| SEAT Sedile | BACK Schienale | FRAME Telaio | POWDER COATED Verniciato | CHROMED Cromato | BLACK CHROMED Cromato nero | VAT NOT INCLUDED Iva esclusa 22% |
|----------------|-------------------|-----------------|--|--------------------|-------------------------------|--|
| PPL | PPL | Ø 14 | € 239,50 Frame in the same colour of shell, GI frame finish excluded Telaio in tinta con la scocca, escluso telaio finitura GI | € 239,50 | € 196,30 | € 219,70 |
| | | | | | € 268,50 | |

White front side always
Scocca interna sempre bianca

PPL FINISHES / Finiture PPL

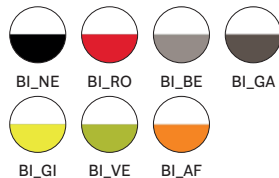

PACKING / Imballo



TECHNICAL DETAILS / Dettagli tecnici



Tweet 898

One-colour
Monocolore



| SEAT Sedile | BACK Schienale | FRAME Telaio | WHITE/BLACK/BEIGE POWDER COATED Verniciato bianco/nero/beige | CHROMED Cromato | VAT NOT INCLUDED Iva esclusa 22% |
|----------------|-------------------|-----------------|--|--------------------|--|
| PPL | PPL | Ø 11 | € 249,50 | | € 204,10 |
| | | | | € 265,00 | € 217,10 |

PPL FINISHES / Finiture PPL

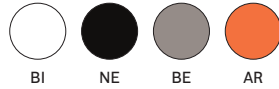

PACKING / Imballo



TECHNICAL DETAILS / Dettagli tecnici

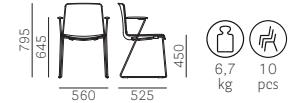

Tweet 898

Bicolour
Bicolore



| SEAT Sedile | BACK Schienale | FRAME Telaio | POWDER COATED Verniciato | CHROMED Cromato | VAT NOT INCLUDED Iva esclusa 22% |
|----------------|-------------------|-----------------|---|--------------------|--|
| PPL | PPL | Ø 11 | € 249,50 Frame in the same colour of shell, GI frame finish excluded Telaio in tinta con la scocca, escluso telaio finitura GI | | € 204,10 |
| | | | | € 265,00 | € 217,10 |

White front side always
Scocca interna sempre bianca

PPL FINISHES / Finiture PPL

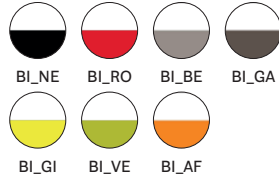

PACKING / Imballo



TECHNICAL DETAILS / Dettagli tecnici

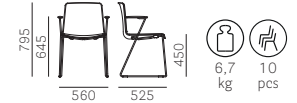

Tweet 895/2

SOFT



| SEAT Sedile | BACK Schienale | FRAME Telaio | WHITE/BLACK POWDER COATED Verniciato bianco/nero | CHROMED Cromato | VAT NOT INCLUDED Iva esclusa 22% | ANTIQU BRASS Ottone anticato | VAT NOT INCLUDED Iva esclusa 22% |
|----------------|-------------------|-----------------|--|--------------------|--|---------------------------------|--|
| C | C | Ø 14 | € 561,50 | € 561,50 | € 460,20 | € 657,00 | € 538,20 |
| E | E | | € 728,00 | € 728,00 | € 596,70 | € 823,50 | € 674,70 |
| G | G | | € 728,00 | € 728,00 | € 596,70 | € 823,50 | € 674,70 |
| H | H | | € 584,00 | € 584,00 | € 478,40 | € 679,00 | € 556,40 |

For fabrics see page 306
Per i tessuti si veda a p. 306

PACKING / Imballo



TECHNICAL DETAILS / Dettagli tecnici



Tweet 898/2

SOFT



| SEAT Sedile | BACK Schienale | FRAME Telaio | WHITE/BLACK POWDER COATED Verniciato bianco/nero | VAT NOT INCLUDED Iva esclusa 22% | CHROMED Cromato | VAT NOT INCLUDED Iva esclusa 22% | ANTIQUÉ BRASS Ottone anticato | VAT NOT INCLUDED Iva esclusa 22% |
|----------------|-------------------|-----------------|--|---|--------------------|---|-------------------------------------|---|
| C | C | Ø 11 | € 571,00 | € 468,00 | € 587,00 | € 481,00 | € 682,00 | € 559,00 |
| E | E | | € 737,50 | € 604,50 | € 753,50 | € 617,50 | € 849,00 | € 695,50 |
| G | G | | € 737,50 | € 604,50 | € 753,50 | € 617,50 | € 849,00 | € 695,50 |
| H | H | | € 593,50 | € 486,20 | € 609,50 | € 499,20 | € 704,50 | € 577,20 |

For fabrics see page 306
Per i tessuti si veda a p. 306

PACKING / Imballo



TECHNICAL DETAILS / Dettagli tecnici



Tweet 892



| SEAT Sedile | BACK Schienale | FRAME Telaio | POWDER COATED Verniciato | CHROMED Cromato | BLACK CHROMED Cromato nero | VAT NOT INCLUDED Iva esclusa 22% |
|----------------|-------------------|-----------------|-----------------------------|--------------------|-------------------------------|--|
| PPL | PPL | Ø 14 H 650 | € 205,00* | € 205,00 | | € 167,70 |
| | | | | | € 247,50 | € 202,80 |

*Powder coated in the same colour of the shell, GI+AR frame finishes excluded
Verniciato nello stesso colore della scocca, escluso finiture GI+AR

PPL FINISHES / Finiture PPL

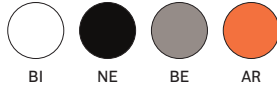

White front side always / Scocca interna sempre bianca



PACKING / Imballo



TECHNICAL DETAILS / Dettagli tecnici



CATAS

Tweet 896



| SEAT Sedile | BACK Schienale | FRAME Telaio | POWDER COATED Verniciato | CHROMED Cromato | BLACK CHROMED Cromato nero | VAT NOT INCLUDED Iva esclusa 22% |
|----------------|-------------------|-----------------|-----------------------------|--------------------|-------------------------------|--|
| PPL | PPL | Ø 14 H 750 | € 208,00* | € 208,00 | | € 170,30 |
| | | | | | € 251,00 | € 205,40 |

*Powder coated in the same colour of the shell, GI+AR frame finishes excluded
Verniciato nello stesso colore della scocca, escluso finiture GI+AR

PPL FINISHES / Finiture PPL

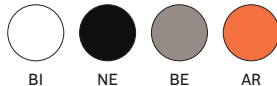

White front side always / Scocca interna sempre bianca

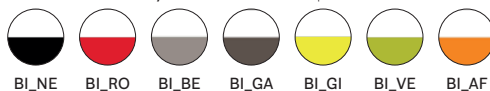

PACKING / Imballo



TECHNICAL DETAILS / Dettagli tecnici



CATAS

Tweet 892/2

SOFT



| SEAT Sedile | BACK Schienale | FRAME Telaio | WHITE/BLACK POWDER COATED Verniciato bianco/nero | CHROMED Cromato | VAT NOT INCLUDED Iva esclusa 22% | ANTIQUÉ BRASS Ottone anticato | VAT NOT INCLUDED Iva esclusa 22% |
|----------------|-------------------|-----------------|--|--------------------|--|----------------------------------|--|
| C | C | Ø 14 H 660 | € 458,50 | € 458,50 | € 375,70 | € 561,50 | € 460,20 |
| E | E | | € 601,50 | € 601,50 | € 492,70 | € 704,50 | € 577,20 |
| G | G | | € 601,50 | € 601,50 | € 492,70 | € 704,50 | € 577,20 |
| H | H | | € 477,50 | € 477,50 | € 391,30 | € 580,50 | € 475,80 |

For fabrics see page 306
Per i tessuti si veda a p. 306

PACKING / Imballo



TECHNICAL DETAILS / Dettagli tecnici

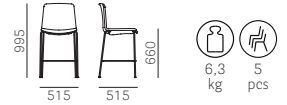

Tweet 896/2

SOFT



| SEAT Sedile | BACK Schienale | FRAME Telaio | WHITE/BLACK POWDER COATED Verniciato bianco/nero | CHROMED Cromato | VAT NOT INCLUDED Iva esclusa 22% | ANTIQUÉ BRASS Ottone anticato | VAT NOT INCLUDED Iva esclusa 22% |
|----------------|-------------------|-----------------|--|--------------------|--|----------------------------------|--|
| C | C | Ø 14 H 760 | € 462,00 | € 462,00 | € 378,30 | € 565,00 | € 462,80 |
| E | E | | € 604,50 | € 604,50 | € 495,30 | € 707,50 | € 579,80 |
| G | G | | € 604,50 | € 604,50 | € 495,30 | € 707,50 | € 579,80 |
| H | H | | € 481,00 | € 481,00 | € 393,90 | € 584,00 | € 478,40 |

For fabrics see page 306
Per i tessuti si veda a p. 306

PACKING / Imballo



TECHNICAL DETAILS / Dettagli tecnici



Twig 429



| SEAT Sedile | BACK Schienale | FRAME Telaio | OAK Rovere | VAT NOT INCLUDED Iva esclusa 22% |
|----------------|-------------------|-------------------|---------------|--|
| H | RS-N1-W- GC-BI | RS-N1-W- GC-BI | € 293,50 | € 240,50 |

For fabrics see page 306
Per i tessuti si veda a p. 306

FINISHES / Finiture



PACKING / Imballo



TECHNICAL DETAILS / Dettagli tecnici

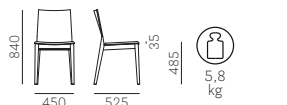

CATAS

Vic 655

ABS shell below cover
Guscio sottoscocca in ABS



| SEAT Sedile | BACK Schienale | FRAME Telaio | ASH Frassino | VAT NOT INCLUDED Iva esclusa 22% |
|----------------|-------------------|-----------------|-------------------|--|
| C83+C101 | C83+C101 | | € 955,00 | € 782,60 |
| E | E | FR-N1- AN-GC | € 1.175,50 | € 963,30 |
| PF* | PF* | | € 1.302,50 | € 1.067,30 |

*Perforated mid-grain leather (inner part of the back, upper part of the seat)
Pelle forata (parte interna dello schienale e parte superiore del sedile)

For fabrics see page 306
Per i tessuti si veda a p. 306

FINISHES / Finiture



ABS SHELL BELOW COVER / Guscio sottoscocca in ABS



NE

PACKING / Imballo



TECHNICAL DETAILS / Dettagli tecnici

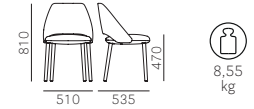

Vic Metal 656

Upholstered shell below cover
Guscio sottoscocca imbottito



| SEAT Sedile | BACK Schienale | FRAME Telaio | BLACK POWDER COATED Verniciato nero | VAT NOT INCLUDED Iva esclusa 22% | ANTIQU BRASS Ottone anticato | VAT NOT INCLUDED Iva esclusa 22% |
|----------------|-------------------|-----------------|---|--|---------------------------------|--|
| C83+C101 | C83+C101 | | € 1.007,50 | € 825,50 | € 1.071,00 | € 877,50 |
| E | E | Ø 25 | € 1.264,50 | € 1.036,10 | € 1.327,50 | € 1.088,10 |
| PF* | PF* | | € 1.399,00 | € 1.146,60 | € 1.462,50 | € 1.198,60 |

*Perforated mid-grain leather (inner part of the back, upper part of the seat)
Pelle forata (parte interna dello schienale e parte superiore del sedile)

For fabrics see page 306
Per i tessuti si veda a p. 306

PACKING / Imballo



TECHNICAL DETAILS / Dettagli tecnici

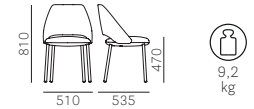

Vic Metal 657

ABS shell below cover
Guscio sottoscocca in ABS



| SEAT Sedile | BACK Schienale | FRAME Telaio | BLACK POWDER COATED Verniciato nero | VAT NOT INCLUDED Iva esclusa 22% | ANTIQU BRASS Ottone anticato | VAT NOT INCLUDED Iva esclusa 22% |
|----------------|-------------------|-----------------|---|--|---------------------------------|--|
| C83+C101 | C83+C101 | | € 923,50 | € 756,60 | € 986,50 | € 808,60 |
| E | E | Ø 25 | € 1.144,00 | € 937,30 | € 1.207,00 | € 989,30 |
| PF* | PF* | | € 1.270,50 | € 1.041,30 | € 1.334,00 | € 1.093,30 |

*Perforated mid-grain leather (inner part of the back, upper part of the seat)
Pelle forata (parte interna dello schienale e parte superiore del sedile)

For fabrics see page 306
Per i tessuti si veda a p. 306

ABS SHELL BELOW COVER / Guscio sottoscocca in ABS



NE

PACKING / Imballo



TECHNICAL DETAILS / Dettagli tecnici

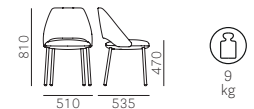

Vic 645

ABS shell below cover
Guscio sottoscocca in ABS

| SEAT Sedile | BACK Schienale | FRAME Telaio | ASH Frassino | VAT NOT INCLUDED Iva esclusa 22% |
|----------------|-------------------|-----------------|-------------------|--|
| C83+C101 | C83+C101 | | € 1.026,50 | € 841,10 |
| E | E | FR-N1- AN-GC | € 1.269,00 | € 1.040,00 |
| PF* | PF* | | € 1.467,50 | € 1.202,50 |

*Perforated mid-grain leather (inner part of the back, upper part of the seat)
Pelle forata (parte interna dello schienale e parte superiore del sedile)

For fabrics see page 306
Per i tessuti si veda a p. 306

WOODEN FINISHES / Finiture legno



ABS SHELL BELOW COVER / Guscio sottoscocca in ABS



PACKING / Imballo



TECHNICAL DETAILS / Dettagli tecnici

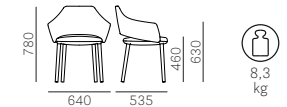

CATAS



Vic Metal 646

Upholstered shell below cover
Guscio sottoscocca imbottito

| SEAT Sedile | BACK Schienale | FRAME Telaio | BLACK POWDER COATED Verniciato nero | VAT NOT INCLUDED Iva esclusa 22% | ANTIQU BRASS Ottone anticato | VAT NOT INCLUDED Iva esclusa 22% |
|----------------|-------------------|-----------------|---|--|---------------------------------|--|
| C83+C101 | C83+C101 | | € 1.078,50 | € 884,00 | € 1.142,00 | € 936,00 |
| E | E | Ø 25 | € 1.358,00 | € 1.112,80 | € 1.421,50 | € 1.164,80 |
| PF* | PF* | | € 1.564,00 | € 1.281,80 | € 1.627,50 | € 1.333,80 |

*Perforated mid-grain leather (inner part of the back, upper part of the seat)
Pelle forata (parte interna dello schienale e parte superiore del sedile)

For fabrics see page 306
Per i tessuti si veda a p. 306

PACKING / Imballo



TECHNICAL DETAILS / Dettagli tecnici

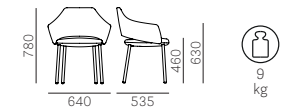

Vic Metal 647

ABS shell below cover
Guscio sottoscocca in ABS

| SEAT Sedile | BACK Schienale | FRAME Telaio | BLACK POWDER COATED Verniciato nero | VAT NOT INCLUDED Iva esclusa 22% | ANTIQU BRASS Ottone anticato | VAT NOT INCLUDED Iva esclusa 22% |
|----------------|-------------------|-----------------|---|--|---------------------------------|--|
| C83+C101 | C83+C101 | | € 994,50 | € 815,10 | € 1.058,00 | € 867,10 |
| E | E | Ø 25 | € 1.237,50 | € 1.014,00 | € 1.301,00 | € 1.066,00 |
| PF* | PF* | | € 1.435,50 | € 1.176,50 | € 1.499,00 | € 1.228,50 |

*Perforated mid-grain leather (inner part of the back, upper part of the seat)
Pelle forata (parte interna dello schienale e parte superiore del sedile)

For fabrics see page 306
Per i tessuti si veda a p. 306

ABS SHELL BELOW COVER / Guscio sottoscocca in ABS



PACKING / Imballo



TECHNICAL DETAILS / Dettagli tecnici

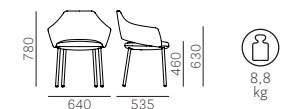

Vic Metal 659

Upholstered shell below cover
Guscio sottoscocca imbottito

| SEAT Sedile | BACK Schienale | FRAME Telaio | BLACK POWDER COATED Verniciato nero | VAT NOT INCLUDED Iva esclusa 22% | ANTIQUÉ BRASS Ottone anticato | VAT NOT INCLUDED Iva esclusa 22% |
|----------------|-------------------|-----------------|---|--|----------------------------------|--|
| C83+C101 | C83+C101 | | € 1.086,50 | € 890,50 | € 1.199,50 | € 982,80 |
| E | E | H660 | € 1.343,50 | € 1.101,10 | € 1.456,00 | € 1.193,40 |
| PF* | PF* | | € 1.478,50 | € 1.211,60 | € 1.591,00 | € 1.303,90 |

*Perforated mid-grain leather (inner part of the back, upper part of the seat)
Pelle forata (parte interna dello schienale e parte superiore del sedile)For fabrics see page 306
Per i tessuti si veda a p. 306

PACKING / Imballo



TECHNICAL DETAILS / Dettagli tecnici

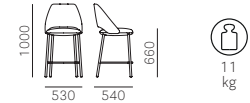

Vic Metal 659/2

ABS shell below cover
Guscio sottoscocca in ABS

| SEAT Sedile | BACK Schienale | FRAME Telaio | BLACK POWDER COATED Verniciato nero | VAT NOT INCLUDED Iva esclusa 22% | ANTIQUÉ BRASS Ottone anticato | VAT NOT INCLUDED Iva esclusa 22% |
|----------------|-------------------|-----------------|---|--|----------------------------------|--|
| C83+C101 | C83+C101 | | € 1.002,50 | € 821,60 | € 1.115,00 | € 913,90 |
| E | E | H660 | € 1.223,00 | € 1.002,30 | € 1.335,50 | € 1.094,60 |
| PF* | PF* | | € 1.350,00 | € 1.106,30 | € 1.462,50 | € 1.198,60 |

*Perforated mid-grain leather (inner part of the back, upper part of the seat)
Pelle forata (parte interna dello schienale e parte superiore del sedile)For fabrics see page 306
Per i tessuti si veda a p. 306

ABS SHELL BELOW COVER / Guscio sottoscocca in ABS



NE

PACKING / Imballo



TECHNICAL DETAILS / Dettagli tecnici

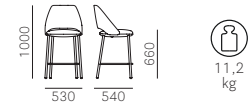

Vic Metal 658

Upholstered shell below cover
Guscio sottoscocca imbottito

| SEAT Sedile | BACK Schienale | FRAME Telaio | BLACK POWDER COATED Verniciato nero | VAT NOT INCLUDED Iva esclusa 22% | ANTIQUÉ BRASS Ottone anticato | VAT NOT INCLUDED Iva esclusa 22% |
|----------------|-------------------|-----------------|---|--|----------------------------------|--|
| C83+C101 | C83+C101 | | € 1.094,50 | € 897,00 | € 1.215,00 | € 995,80 |
| E | E | H760 | € 1.351,50 | € 1.107,60 | € 1.472,00 | € 1.206,40 |
| PF* | PF* | | € 1.486,50 | € 1.218,10 | € 1.607,00 | € 1.316,90 |

*Perforated mid-grain leather (inner part of the back, upper part of the seat)
Pelle forata (parte interna dello schienale e parte superiore del sedile)For fabrics see page 306
Per i tessuti si veda a p. 306

PACKING / Imballo



TECHNICAL DETAILS / Dettagli tecnici



Vic Metal 658/2

ABS shell below cover
Guscio sottoscocca in ABS



| SEAT Sedile | BACK Schienale | FRAME Telaio | BLACK POWDER COATED Verniciato nero | VAT NOT INCLUDED Iva esclusa 22% | ANTIQUÉ BRASS Ottone anticato | VAT NOT INCLUDED Iva esclusa 22% |
|----------------|-------------------|-----------------|---|--|----------------------------------|--|
| C83+C101 | C83+C101 | | € 1.010,50 | € 828,10 | € 1.131,00 | € 926,90 |
| E | E | H760 | € 1.231,00 | € 1.008,80 | € 1.351,50 | € 1.107,60 |
| PF* | PF* | | € 1.358,00 | € 1.112,80 | € 1.478,50 | € 1.211,60 |

*Perforated mid-grain leather (inner part of the back, upper part of the seat)
Pelle forata (parte interna dello schienale e parte superiore del sedile)

For fabrics see page 306
Per i tessuti si veda a p. 306

ABS SHELL BELOW COVER / Guscio sottoscocca in ABS



NE

PACKING / Imballo



TECHNICAL DETAILS / Dettagli tecnici

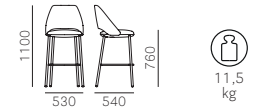

Vic Metal 649

Upholstered shell below cover
Guscio sottoscocca imbottito



| SEAT Sedile | BACK Schienale | FRAME Telaio | BLACK POWDER COATED Verniciato nero | VAT NOT INCLUDED Iva esclusa 22% | ANTIQUÉ BRASS Ottone anticato | VAT NOT INCLUDED Iva esclusa 22% |
|----------------|-------------------|-----------------|---|--|----------------------------------|--|
| C83+C101 | C83+C101 | | € 1.158,00 | € 949,00 | € 1.270,50 | € 1.041,30 |
| E | E | H 650 | € 1.437,00 | € 1.177,80 | € 1.550,00 | € 1.270,10 |
| PF* | PF* | | € 1.643,50 | € 1.346,80 | € 1.756,00 | € 1.439,10 |

*Perforated mid-grain leather (inner part of the back, upper part of the seat)
Pelle forata (parte interna dello schienale e parte superiore del sedile)

For fabrics see page 306
Per i tessuti si veda a p. 306

PACKING / Imballo



TECHNICAL DETAILS / Dettagli tecnici

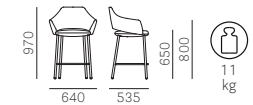

Vic Metal 649/2

ABS shell below cover
Guscio sottoscocca in ABS



| SEAT Sedile | BACK Schienale | FRAME Telaio | BLACK POWDER COATED Verniciato nero | VAT NOT INCLUDED Iva esclusa 22% | ANTIQUÉ BRASS Ottone anticato | VAT NOT INCLUDED Iva esclusa 22% |
|----------------|-------------------|-----------------|---|--|----------------------------------|--|
| C83+C101 | C83+C101 | | € 1.074,00 | € 880,10 | € 1.186,50 | € 972,40 |
| E | E | H 650 | € 1.316,50 | € 1.079,00 | € 1.429,00 | € 1.171,30 |
| PF* | PF* | | € 1.515,00 | € 1.241,50 | € 1.627,50 | € 1.333,80 |

*Perforated mid-grain leather (inner part of the back, upper part of the seat)
Pelle forata (parte interna dello schienale e parte superiore del sedile)

For fabrics see page 306
Per i tessuti si veda a p. 306

ABS SHELL BELOW COVER / Guscio sottoscocca in ABS



NE

PACKING / Imballo



TECHNICAL DETAILS / Dettagli tecnici

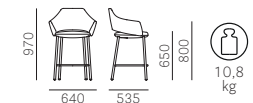

CATAS

Vic Metal 648

Upholstered shell below cover
Guscio sottoscocca imbottito



| SEAT Sedile | BACK Schienale | FRAME Telaio | BLACK POWDER COATED Verniciato nero | VAT NOT INCLUDED Iva esclusa 22% | ANTIQUÉ BRASS Ottone anticato | VAT NOT INCLUDED Iva esclusa 22% |
|----------------|-------------------|-----------------|---|--|----------------------------------|--|
| C83+C101 | C83+C101 | | € 1.166,00 | € 955,50 | € 1.286,50 | € 1.054,30 |
| E | E | H 750 | € 1.445,00 | € 1.184,30 | € 1.565,50 | € 1.283,10 |
| PF* | PF* | | € 1.651,50 | € 1.353,30 | € 1.772,00 | € 1.452,10 |

*Perforated mid-grain leather (inner part of the back, upper part of the seat)
Pelle forata (parte interna dello schienale e parte superiore del sedile)

For fabrics see page 306
Per i tessuti si veda a p. 306

PACKING / Imballo



TECHNICAL DETAILS / Dettagli tecnici



CATAS

Vic Metal 648/2

ABS shell below cover
Guscio sottoscocca in ABS



| SEAT Sedile | BACK Schienale | FRAME Telaio | BLACK POWDER COATED Verniciato nero | VAT NOT INCLUDED Iva esclusa 22% | ANTIQUÉ BRASS Ottone anticato | VAT NOT INCLUDED Iva esclusa 22% |
|----------------|-------------------|-----------------|---|--|----------------------------------|--|
| C83+C101 | C83+C101 | | € 1.082,00 | € 886,60 | € 1.202,50 | € 985,40 |
| E | E | H 750 | € 1.324,50 | € 1.085,50 | € 1.445,00 | € 1.184,30 |
| PF* | PF* | | € 1.523,00 | € 1.248,00 | € 1.643,50 | € 1.346,80 |

*Perforated mid-grain leather (inner part of the back, upper part of the seat)
Pelle forata (parte interna dello schienale e parte superiore del sedile)

For fabrics see page 306
Per i tessuti si veda a p. 306

ABS SHELL BELOW COVER / Guscio sottoscocca in ABS



NE

PACKING / Imballo



TECHNICAL DETAILS / Dettagli tecnici

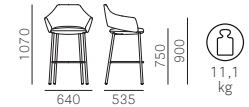

CATAS

Volt 670



| SEAT Sedile | BACK Schienale | FRAME Telaio | POLYPROPYLENE Polipropilene | VAT NOT INCLUDED Iva esclusa 22% |
|----------------|-------------------|-----------------|--------------------------------|--|
| PPL | PPL | PPL | € 98,50 | € 80,60 |

PPL FINISHES / Finiture PPL

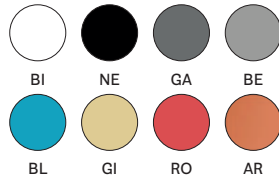

PACKING / Imballo



TECHNICAL DETAILS / Dettagli tecnici

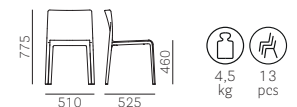

CATAS



PRODUCT CERTIFIED
FOR LOW CHEMICAL
EMISSIONS:
UL.COM/MG
UL 2818

Volt 671



| SEAT Sedile | BACK Schienale | FRAME Telaio | FABRIC Tessuto | VAT NOT INCLUDED Iva esclusa 22% |
|----------------|-------------------|-----------------|-------------------|--|
| C83+C101 | C83+C101 | PPL | € 317,50 | € 260,00 |
| C90+C95 | C90+C95 | | | |

For fabrics see page 306
Per i tessuti si veda a p. 306

PPL FINISHES / Finiture PPL

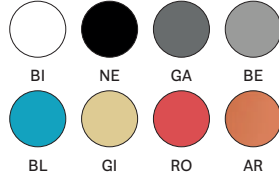

PACKING / Imballo



TECHNICAL DETAILS / Dettagli tecnici



Volt 671/2



| SEAT Sedile | BACK Schienale | FRAME Telaio | FABRIC Tessuto | VAT NOT INCLUDED Iva esclusa 22% |
|----------------|-------------------|-----------------|-------------------|--|
| C83+C101 | PPL | PPL | € 201,50 | € 165,10 |
| C90+C95 | | | | |

For fabrics see page 306
Per i tessuti si veda a p. 306

PPL FINISHES / Finiture PPL

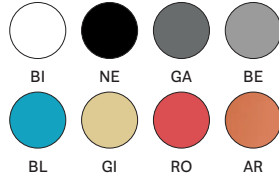

PACKING / Imballo



TECHNICAL DETAILS / Dettagli tecnici

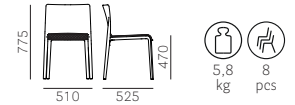

Volt 675



| SEAT Sedile | BACK Schienale | FRAME Telaio | POLYPROPYLENE Polipropilene | VAT NOT INCLUDED Iva esclusa 22% |
|----------------|-------------------|-----------------|--------------------------------|--|
| PPL | PPL | PPL | € 114,50 | € 93,60 |

PPL FINISHES / Finiture PPL

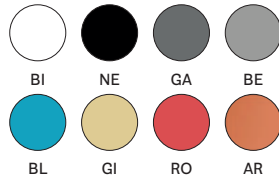

PACKING / Imballo



TECHNICAL DETAILS / Dettagli tecnici

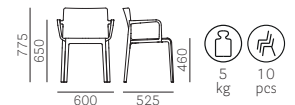

Volt 676



| SEAT Sedile | BACK Schienale | FRAME Telaio | FABRIC Tessuto | VAT NOT INCLUDED Iva esclusa 22% |
|----------------|-------------------|-----------------|-------------------|--|
| C83+C101 | C83+C101 | PPL | € 333,50 | € 273,00 |
| C90+C95 | C90+C95 | | | |

For fabrics see page 306
Per i tessuti si veda a p. 306

PPL FINISHES / Finiture PPL

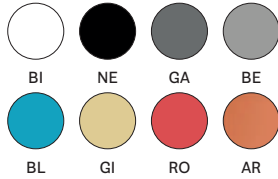

PACKING / Imballo



TECHNICAL DETAILS / Dettagli tecnici

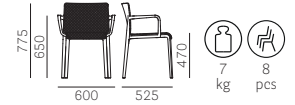

Volt 676/2



| SEAT Sedile | BACK Schienale | FRAME Telaio | FABRIC Tessuto | VAT NOT INCLUDED Iva esclusa 22% |
|----------------|-------------------|-----------------|-------------------|--|
| C83+C101 | PPL | PPL | € 217,50 | € 178,10 |
| C90+C95 | | | | |

For fabrics see page 306
Per i tessuti si veda a p. 306

PPL FINISHES / Finiture PPL



PACKING / Imballo



TECHNICAL DETAILS / Dettagli tecnici

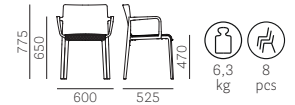

Volt 677



| SEAT Sedile | BACK Schienale | FRAME Telaio | POLYPROPYLENE Polipropilene | VAT NOT INCLUDED Iva esclusa 22% |
|----------------|-------------------|-----------------|--------------------------------|--|
| PPL | PPL | PPL H 660 | € 122,50 | € 100,10 |
| | | | | |

PPL FINISHES / Finiture PPL

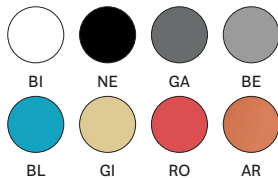

PACKING / Imballo



TECHNICAL DETAILS / Dettagli tecnici

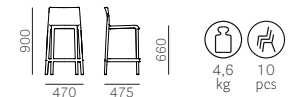

Volt 677/2



| SEAT Sedile | BACK Schienale | FRAME Telaio | FABRIC Tessuto | VAT NOT INCLUDED Iva esclusa 22% |
|----------------|-------------------|-----------------|-------------------|--|
| C83+C101 | PPL | PPL H 680 | € 225,50 | € 184,60 |
| C90+C95 | | | | |

For fabrics see page 306
Per i tessuti si veda a p. 306

PPL FINISHES / Finiture PPL

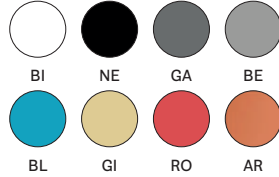

PACKING / Imballo



TECHNICAL DETAILS / Dettagli tecnici

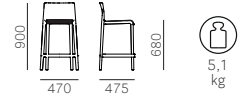

Volt 678



| SEAT Sedile | BACK Schienale | FRAME Telaio | POLYPROPYLENE Polipropilene | VAT NOT INCLUDED Iva esclusa 22% |
|----------------|-------------------|-----------------|--------------------------------|--|
| PPL | PPL | PPL H 765 | € 122,50 | € 100,10 |

PPL FINISHES / Finiture PPL

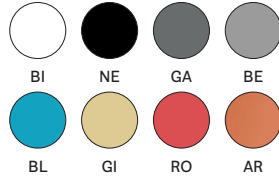

PACKING / Imballo



TECHNICAL DETAILS / Dettagli tecnici

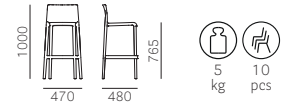

CATAS



PRODUCT CERTIFIED
FOR LOW CHEMICAL
EMISSIONS:
UL.COM/GG
UL 2818

Volt 678/2



| SEAT Sedile | BACK Schienale | FRAME Telaio | FABRIC Tessuto | VAT NOT INCLUDED Iva esclusa 22% |
|----------------|-------------------|-----------------|-------------------|--|
| C83+C101 | PPL | PPL H 785 | € 225,50 | € 184,60 |
| C90+C95 | | | | |

For fabrics see page 306
Per i tessuti si veda a p. 306

PPL FINISHES / Finiture PPL

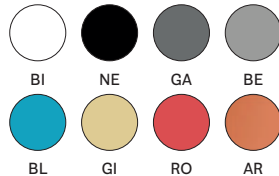

PACKING / Imballo



TECHNICAL DETAILS / Dettagli tecnici

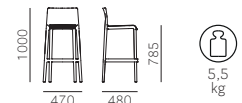

CATAS

Volt HB 673



| SEAT Sedile | BACK Schienale | FRAME Telaio | POLYPROPYLENE Polipropilene | VAT NOT INCLUDED Iva esclusa 22% |
|----------------|-------------------|-----------------|--------------------------------|--|
| PPL | PPL | PPL | € 102,00 | € 83,20 |

PPL FINISHES / Finiture PPL

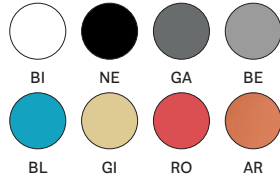

PACKING / Imballo



TECHNICAL DETAILS / Dettagli tecnici

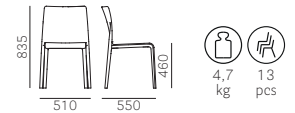

PRODUCT CERTIFIED FOR LOW CHEMICAL EMISSIONS: UL.COM/SGG UL 2818

Volt HB 673/2



| SEAT Sedile | BACK Schienale | FRAME Telaio | FABRIC Tessuto | VAT NOT INCLUDED Iva esclusa 22% |
|----------------|-------------------|-----------------|-------------------|--|
| C83+C101 | PPL | PPL | € 205,00 | € 167,70 |
| C90+C95 | | | | |

For fabrics see page 306
Per i tessuti si veda a p. 306

PPL FINISHES / Finiture PPL

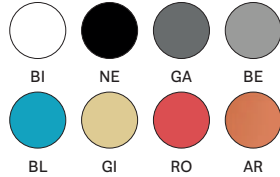

PACKING / Imballo



TECHNICAL DETAILS / Dettagli tecnici

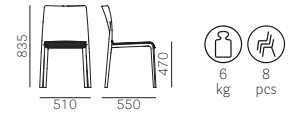

Volt HB 674



| SEAT Sedile | BACK Schienale | FRAME Telaio | POLYPROPYLENE Polipropilene | VAT NOT INCLUDED Iva esclusa 22% |
|----------------|-------------------|-----------------|--------------------------------|--|
| PPL | PPL | PPL | € 117,50 | € 96,20 |

PPL FINISHES / Finiture PPL

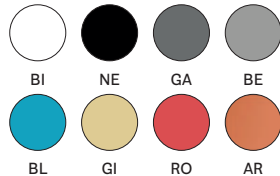

PACKING / Imballo



TECHNICAL DETAILS / Dettagli tecnici

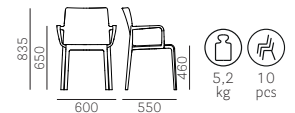

PRODUCT CERTIFIED FOR LOW CHEMICAL EMISSIONS: UL.COM/SGG UL 2818

Volt HB 674/2



| SEAT Sedile | BACK Schienale | FRAME Telaio | FABRIC Tessuto | VAT NOT INCLUDED Iva esclusa 22% |
|----------------|-------------------|-----------------|-------------------|--|
| C83+C101 | | | | |
| | PPL | PPL | € 220,50 | € 180,70 |
| C90+C95 | | | | |

For fabrics see page 306
Per i tessuti si veda a p. 306

PPL FINISHES / Finiture PPL

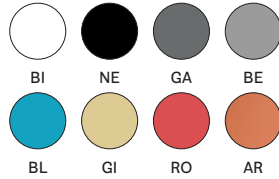

PACKING / Imballo



TECHNICAL DETAILS / Dettagli tecnici

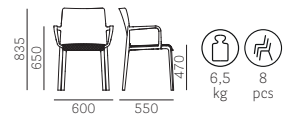

Woody 495

Gas lift device
Alzata a gas



| SEAT Sedile | FRAME Telaio | CHROMED Cromato | SATINIZED Satinato | VAT NOT INCLUDED Iva esclusa 22% |
|----------------|-------------------|--------------------|-----------------------|--|
| RS-W | Ø 400 H640÷780 | € 438,00 | | € 358,80 |
| | | | € 463,50 | € 379,60 |

FINISHES / Finiture



PACKING / Imballo



TECHNICAL DETAILS / Dettagli tecnici

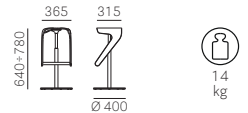

Woody 497

Gas lift device
Alzata a gas



| SEAT Sedile | FRAME Telaio | CHROMED Cromato | SATINIZED Satinato | VAT NOT INCLUDED Iva esclusa 22% |
|--------------------------|-------------------|--------------------|-----------------------|--|
| F01 F05 F06 F07 | Ø 400 H650÷790 | € 730,00 | | € 598,00 |
| | | | € 755,00 | € 618,80 |

GENUINE LEATHER FINISHES / Finiture cuoio naturale



PACKING / Imballo

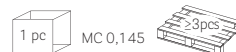

TECHNICAL DETAILS / Dettagli tecnici



Wow 320



| SEAT Sedile | FRAME Telaio | FABRIC Tessuto | VAT NOT INCLUDED Iva esclusa 22% |
|----------------|------------------|-------------------|--|
| C | | € 235,00 | € 192,40 |
| G | 360x360 H 480 | € 351,00 | € 287,30 |
| H | | € 243,50 | € 199,55 |

For fabrics see page 306
Per i tessuti si veda a p. 306

PACKING / Imballo



TECHNICAL DETAILS / Dettagli tecnici

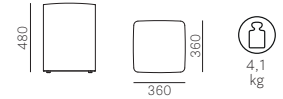

Wow 321



| SEAT Sedile | FRAME Telaio | FABRIC Tessuto | VAT NOT INCLUDED Iva esclusa 22% |
|----------------|------------------|-------------------|--|
| C | | € 416,00 | € 340,60 |
| G | 910x360 H 480 | € 594,00 | € 486,85 |
| H | | € 430,00 | € 352,30 |

For fabrics see page 306
Per i tessuti si veda a p. 306

PACKING / Imballo



TECHNICAL DETAILS / Dettagli tecnici

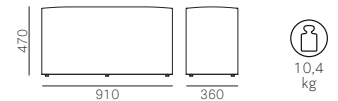

Wow 322



| SEAT Sedile | FRAME Telaio | FABRIC Tessuto | VAT NOT INCLUDED Iva esclusa 22% |
|----------------|-----------------|-------------------|--|
| C | | € 229,50 | € 187,85 |
| G | Ø 400 H 480 | € 339,00 | € 277,55 |
| H | | € 238,00 | € 195,00 |

For fabrics see page 306
Per i tessuti si veda a p. 306

PACKING / Imballo



TECHNICAL DETAILS / Dettagli tecnici

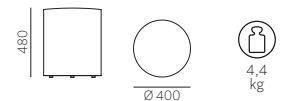

Wow 323



| SEAT Sedile | FRAME Telaio | FABRIC Tessuto | VAT NOT INCLUDED Iva esclusa 22% |
|----------------|-----------------|-------------------|--|
| C | | € 394,50 | € 323,05 |
| G | Ø 650 H 430 | € 577,50 | € 473,20 |
| H | | € 408,50 | € 334,75 |

For fabrics see page 306
Per i tessuti si veda a p. 306

PACKING / Imballo



TECHNICAL DETAILS / Dettagli tecnici

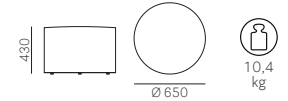

Wow 324



| SEAT Sedile | FRAME Telaio | FABRIC Tessuto | VAT NOT INCLUDED Iva esclusa 22% |
|----------------|------------------|-------------------|--|
| C | | € 398,50 | € 326,30 |
| G | 600x600 H 430 | € 582,50 | € 477,10 |
| H | | € 412,50 | € 338,00 |

For fabrics see page 306
Per i tessuti si veda a p. 306

PACKING / Imballo



TECHNICAL DETAILS / Dettagli tecnici

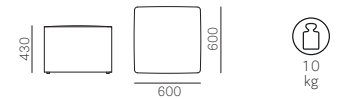

Wow 325



| SEAT Sedile | FRAME Telaio | FABRIC Tessuto | VAT NOT INCLUDED Iva esclusa 22% |
|----------------|-----------------|-------------------|--|
| C | | € 579,00 | € 474,50 |
| G | Ø 850 H 430 | € 823,50 | € 674,70 |
| H | | € 598,00 | € 490,10 |

For fabrics see page 306
Per i tessuti si veda a p. 306

PACKING / Imballo



TECHNICAL DETAILS / Dettagli tecnici

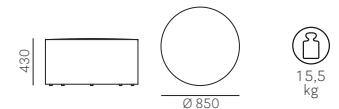

Wow 470



| SEAT Sedile | FRAME Telaio | POLYETHYLENE Polietilene | VAT NOT INCLUDED Iva esclusa 22% |
|----------------|-----------------|-----------------------------|--|
| PET | Ø 660 | € 160,50 | € 131,30 |

PET FINISHES / Finiture PET



PACKING / Imballo



TECHNICAL DETAILS / Dettagli tecnici

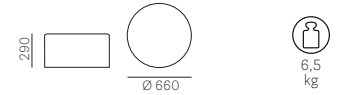

Wow 472



| SEAT Sedile | FRAME Telaio | METHACRYLATE Metacrilato | VAT NOT INCLUDED Iva esclusa 22% |
|----------------|-----------------|-----------------------------|--|
| | Ø 630 | € 182,50 | € 149,50 |

Two-coloured top for WOW item 470
Ripiano bicolore per WOW art.470

ME FINISHES / Finiture ME



PACKING / Imballo



TECHNICAL DETAILS / Dettagli tecnici



Wow 475

LUMINOSO



| SEAT Sedile | FRAME Telaio | POLYETHYLENE Polietilene | VAT NOT INCLUDED Iva esclusa 22% |
|----------------|-----------------|--|--|
| PET | Ø 630 | € 373,00 With hammered white powder coated base Con base verniciata bianco bucciato | € 305,50 |

English plug version: surcharge **€ 48,00** (€ 39,00 vat not included) - item 475_UK
Versione con presa britannica: supplemento **€ 48,00** (€ 39,00 iva esclusa) - art. 475_UK

PET FINISH / Finitura PET



PACKING / Imballo



TECHNICAL DETAILS / Dettagli tecnici

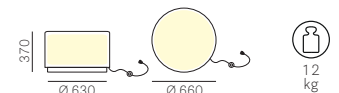

CE 23W ENERGY SAVER
IP20

Wow 475E

LUMINOSO



| SEAT Sedile | FRAME Telaio | POLYETHYLENE Polietilene | VAT NOT INCLUDED Iva esclusa 22% |
|----------------|-----------------|--|--|
| PET | Ø 630 | € 373,00 With zinc-coated base, hammered white powder coated Con base zincata, verniciata bianco bucciato | € 305,50 |

PET FINISH / Finitura PET



BI

PACKING / Imballo



TECHNICAL DETAILS / Dettagli tecnici

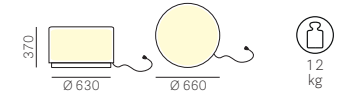

CE 23W ENERGY SAVER
IP44

Wow 475L

LED



| SEAT Sedile | FRAME Telaio | POLYETHYLENE Polietilene | VAT NOT INCLUDED Iva esclusa 22% |
|----------------|-----------------|--|--|
| PET | Ø 630 | € 500,00 With hammered white powder coated base Con base verniciata bianco bucciato | € 409,50 |

PET FINISH / Finitura PET



BI

With LED that change colours: red, yellow, green, violet, blue, light blue
Con LED che cambiano colore: rosso, giallo, verde, viola, blu, azzurro



LED RGB

PACKING / Imballo



TECHNICAL DETAILS / Dettagli tecnici

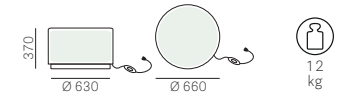

CE IP40

Wow 480



| SEAT Sedile | FRAME Telaio | POLYETHYLENE Polietilene | VAT NOT INCLUDED Iva esclusa 22% |
|----------------|-----------------|-----------------------------|--|
| PET | Ø 400 | € 98,50 | € 80,60 |

PET FINISHES / Finiture PET

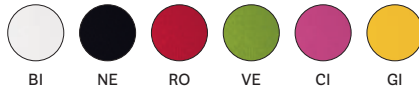

BI

NE

RO

VE

CI

GI

PACKING / Imballo



TECHNICAL DETAILS / Dettagli tecnici



3,6

kg

Wow 482



| SEAT Sedile | FRAME Telaio | METHACRYLATE Metacrilato | VAT NOT INCLUDED Iva esclusa 22% |
|----------------|-----------------|-----------------------------|--|
| | Ø 375 | € 71,50 | € 58,50 |

Two-coloured top for WOW item 480
Ripiano bicolore per WOW art.480

ME FINISHES / Finiture ME



PACKING / Imballo



TECHNICAL DETAILS / Dettagli tecnici



Wow 485

LUMINOSO



| SEAT Sedile | FRAME Telaio | POLYETHYLENE Polietilene | VAT NOT INCLUDED Iva esclusa 22% |
|----------------|-----------------|-----------------------------|--|
| PET | Ø 400 | € 206,50 | € 169,00 |

English plug version: surcharge € 48,00 (€ 39,00 vat not included) - item 485_UK
Versione con presa britannica: supplemento € 48,00 (€ 39,00 iva esclusa) - art. 485_UK

PET FINISH / Finitura PET



PACKING / Imballo



TECHNICAL DETAILS / Dettagli tecnici



CE 23W ENERGY SAVER
IP20

Wow 485E

LUMINOSO



| SEAT Sedile | FRAME Telaio | POLYETHYLENE Polietilene | VAT NOT INCLUDED Iva esclusa 22% |
|----------------|-----------------|-----------------------------|--|
| PET | Ø 400 | € 206,50 | € 169,00 |

PET FINISH / Finitura PET



PACKING / Imballo



TECHNICAL DETAILS / Dettagli tecnici

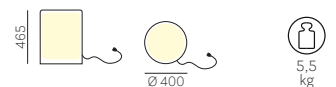

CE 23W ENERGY SAVER
IP44

Wow 485L

LED



| SEAT Sedile | FRAME Telaio | POLYETHYLENE Polietilene | VAT NOT INCLUDED Iva esclusa 22% |
|----------------|-----------------|-----------------------------|--|
| PET | Ø 400 | € 365,00 | € 299,00 |

PET FINISH / Finitura PET



BI



LED RGB

With LED that change colours: red, yellow, green, violet, blue, light blue
Con LED che cambiano colore: rosso, giallo, verde, viola, blu, azzurro

PACKING / Imballo



TECHNICAL DETAILS / Dettagli tecnici

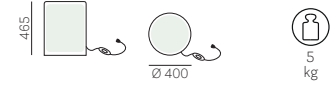

IP40

Wow 486

LUMINOSO



| SEAT Sedile | FRAME Telaio | POLYETHYLENE Polietilene | VAT NOT INCLUDED Iva esclusa 22% |
|----------------|-----------------|--|--|
| | Ø 310 | € 400,00 Methacrylate top included Con ripiano in metacrilato | € 327,60 |

PET FINISH / Finitura PET



BI

ME FINISH / Finitura ME



OP

PACKING / Imballo



TECHNICAL DETAILS / Dettagli tecnici

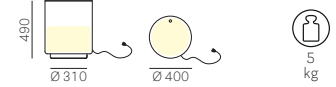

25W ENERGY SAVER
IP20

Young 420



| SEAT Sedile | BACK Schienale | FRAME Telaio | OAK Rovere | VAT NOT INCLUDED Iva esclusa 22% |
|-------------------|-------------------|-------------------|-----------------|--|
| RS-N1-W- GC-BI | RS-N1-W- GC-BI | RS-N1-W- GC-BI | € 331,50 | € 271,70 |

FINISHES / Finiture



RS

N1

W

GC

BI

PACKING / Imballo



TECHNICAL DETAILS / Dettagli tecnici



CATAS

Young 425



| SEAT Sedile | BACK Schienale | FRAME Telaio | OAK Rovere | VAT NOT INCLUDED Iva esclusa 22% |
|-------------------|-------------------|-------------------|-----------------|--|
| RS-N1-W- GC-BI | RS-N1-W- GC-BI | RS-N1-W- GC-BI | € 460,00 | € 377,00 |

FINISHES / Finiture



PACKING / Imballo



TECHNICAL DETAILS / Dettagli tecnici

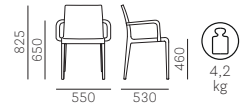

Young 426



| SEAT Sedile | BACK Schienale | FRAME Telaio | OAK Rovere | VAT NOT INCLUDED Iva esclusa 22% |
|-------------------|-------------------|-----------------|-----------------|--|
| RS-N1-W- GC-BI | RS-N1-W- GC-BI | H750 | € 468,00 | € 383,50 |

FINISHES / Finiture



PACKING / Imballo



TECHNICAL DETAILS / Dettagli tecnici

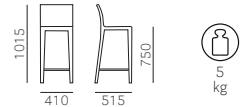

Zippo ZIP2P/100

Low back
Schienale basso



| SEAT Sedile | BACK Schienale | FRAME Telaio | WHITE/BLACK/SILVER POWDER COATED Verniciato bianco/nero/alluminio | VAT NOT INCLUDED Iva esclusa 22% |
|----------------|-------------------|-----------------|--|--|
| A | A | | € 2.205,00 | € 1.807,00 |
| C | C | | € 2.458,50 | € 2.015,00 |
| G | G | Ø 16 | € 3.220,00 | € 2.639,00 |
| H | H | | € 2.506,00 | € 2.054,00 |

Sound absorption measurement: 100 Hz = 1,46 (EN ISO 354:2003)
Coefficiente assorbimento acustico: 100 Hz = 1,46 (EN ISO 354:2003)

FINISHES / Finiture

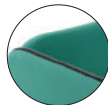

Zip colour matched with frame finish
Colore della zip in tinta col telaio
For fabrics see page 306
Per i tessuti si veda a p. 306

PACKING / Imballo



TECHNICAL DETAILS / Dettagli tecnici

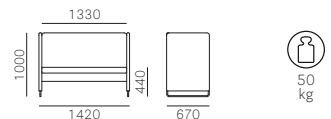

Zippo ZIP2P/140

High back
Schienale alto

| SEAT Sedile | BACK Schienale | FRAME Telaio | WHITE/BLACK/SILVER POWDER COATED Verniciato bianco/nero/alluminio | VAT NOT INCLUDED Iva esclusa 22% |
|----------------|-------------------|-----------------|--|--|
| A | A | Ø 16 | € 2.474,50 | € 2.028,00 |
| C | C | | € 2.728,00 | € 2.236,00 |
| G | G | | € 3.553,00 | € 2.912,00 |
| H | H | | € 2.775,50 | € 2.275,00 |

Sound absorption measurement: 100 Hz = 1,46 (EN ISO 354:2003)
Coefficiente assorbimento acustico: 100 Hz = 1,46 (EN ISO 354:2003)

FINISHES / Finiture

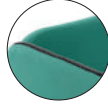
Zip colour matched with frame finish
Colore della zip in tinta col telaio
For fabrics see page 306
Per i tessuti si veda a p. 306

PACKING / Imballo

KD
MC 0,70

TECHNICAL DETAILS / Dettagli tecnici

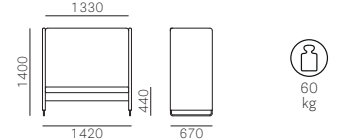

Zippo ZIP1P/100

Low back
Schienale basso

| SEAT Sedile | BACK Schienale | FRAME Telaio | WHITE/BLACK/SILVER POWDER COATED Verniciato bianco/nero/alluminio | VAT NOT INCLUDED Iva esclusa 22% |
|----------------|-------------------|-----------------|--|--|
| A | A | Ø 16 | € 1.943,00 | € 1.592,50 |
| C | C | | € 2.147,50 | € 1.760,20 |
| G | G | | € 2.755,00 | € 2.258,10 |
| H | H | | € 2.184,00 | € 1.790,10 |

Sound absorption measurement: 100 Hz = 1,46 (EN ISO 354:2003)
Coefficiente assorbimento acustico: 100 Hz = 1,46 (EN ISO 354:2003)

FINISHES / Finiture

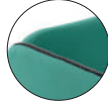
Zip colour matched with frame finish
Colore della zip in tinta col telaio
For fabrics see page 306
Per i tessuti si veda a p. 306

PACKING / Imballo

KD
MC 0,30

TECHNICAL DETAILS / Dettagli tecnici

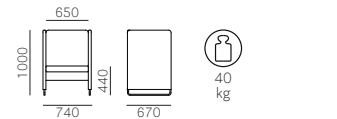

Zippo ZIP1P/140

High back
Schienale alto

| SEAT Sedile | BACK Schienale | FRAME Telaio | WHITE/BLACK/SILVER POWDER COATED Verniciato bianco/nero/alluminio | VAT NOT INCLUDED Iva esclusa 22% |
|----------------|-------------------|-----------------|--|--|
| A | A | Ø 16 | € 2.160,50 | € 1.770,60 |
| C | C | | € 2.406,00 | € 1.972,10 |
| G | G | | € 3.134,00 | € 2.568,80 |
| H | H | | € 2.449,00 | € 2.007,20 |

Sound absorption measurement: 100 Hz = 1,46 (EN ISO 354:2003)
Coefficiente assorbimento acustico: 100 Hz = 1,46 (EN ISO 354:2003)

FINISHES / Finiture

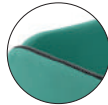
Zip colour matched with frame finish
Colore della zip in tinta col telaio
For fabrics see page 306
Per i tessuti si veda a p. 306

PACKING / Imballo

KD
MC 0,40

TECHNICAL DETAILS / Dettagli tecnici

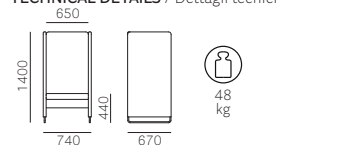

Zippo ZIPL1P

LOUNGE



| SEAT Sedile | BACK Schienale | FRAME Telaio | WHITE/BLACK/SILVER POWDER COATED Verniciato bianco/nero/alluminio | VAT NOT INCLUDED Iva esclusa 22% |
|----------------|-------------------|-----------------|--|--|
| A | A | Ø 16 | € 1.927,00 | € 1.579,50 |
| C | C | | € 2.070,00 | € 1.696,50 |
| G | G | | € 2.495,00 | € 2.044,90 |
| H | H | | € 2.128,50 | € 1.744,60 |

Sound absorption measurement: 100 Hz = 1,46 (EN ISO 354:2003)
Coefficiente assorbimento acustico: 100 Hz = 1,46 (EN ISO 354:2003)

FINISHES / Finiture

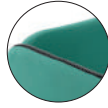

Zip colour matched with frame finish
Colore della zip in tinta col telaio
For fabrics see page 306
Per i tessuti si veda a p. 306

PACKING / Imballo



TECHNICAL DETAILS / Dettagli tecnici

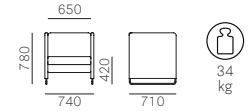

MINIATURES_A

Miniature



POLYCARBONATE AND POLYPROPYLENE
Policarbonato e polipropilene

€ 76,50

3pcs armchair / 3pz poltrona PASHA 660
(BI, NE, TR)



3pcs armchair / 3pz poltrona PLUS 630
(GA, SA, BI)



VAT NOT INCLUDED
Iva esclusa
22%

€ 62,40

PACKING / Imballo



TECHNICAL DETAILS / Dettagli tecnici

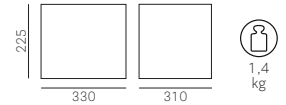

MINIATURES_315_640

Miniature



POLYCARBONATE AND POLYPROPYLENE
Policarbonato e polipropilene

€ 76,50

3pcs armchair / 3pz poltrona ARA 315
(BI, BL, GC)



3pcs chair / 3pz sedia BLITZ 640
(TR, SA, RT)



VAT NOT INCLUDED
Iva esclusa
22%

€ 62,40

PACKING / Imballo



TECHNICAL DETAILS / Dettagli tecnici

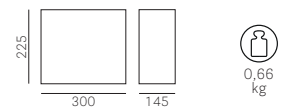

MINIATURES_260_A

Miniature



POLYPROPYLENE
Polipropilene

VAT NOT INCLUDED
Iva esclusa
22%

€ 32,00

3pcs chair / 3pz sedia DOME 260
(BI, NE, VE)



€ 26,00

PACKING / Imballo

TECHNICAL DETAILS / Dettagli tecnici



Package colour: petroleum blue
Colore confezione: petrolio

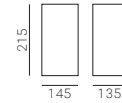

MINIATURES_260_B

Miniature



POLYPROPYLENE
Polipropilene

VAT NOT INCLUDED
Iva esclusa
22%

€ 32,00

3pcs chair / 3pz sedia DOME 260
(BI, NE, VE)



€ 26,00

PACKING / Imballo

TECHNICAL DETAILS / Dettagli tecnici



Package colour: light blue
Colore confezione: azzurro

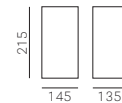

MINIATURES_260_C

Miniature



POLYPROPYLENE
Polipropilene

VAT NOT INCLUDED
Iva esclusa
22%

€ 32,00

3pcs chair / 3pz sedia DOME 260
(BI, NE, VE)



€ 26,00

PACKING / Imballo

TECHNICAL DETAILS / Dettagli tecnici



Package colour: peach
Colore confezione: pesca

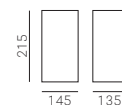

AERO

Fixed tables / Tavoli fissi



| Item Articolo | Frame Telaio Sizes Dimensioni | Finish Finitura | Solid laminate top included Incluso ripiano in stratificato | | | | Glass top included Incluso ripiano in vetro |
|------------------|--|--------------------|--|---------------------------------|---------------------------------|---------------------------------|--|
| | | | CFC_BI (mm 10) | FNP_NE (mm 10) | FNP_3452 (mm 10) | FNP_3455 (mm 10) | FUM (mm 12) |
| TAE_130X130 | 1300X1300 | BI | € 1.967,00 € 1.612,00 | - - | - - | € 2.490,50 € 2.041,00 | - - |
| | | NERO | - - | € 2.094,00 € 1.716,00 | € 2.173,00 € 1.781,00 | - - | € 2.696,50 € 2.210,00 |
| TAE_220X106 | 2200X1060 | BI | € 2.157,00 € 1.768,00 | - - | - - | € 2.950,00 € 2.418,00 | - - |
| | | NERO | - - | € 2.316,00 € 1.898,00 | € 2.474,50 € 2.028,00 | - - | € 2.950,00 € 2.418,00 |

Prices in bold are VAT included (VAT 22%)
I prezzi in grassetto si intendono IVA inclusa (IVA 22%)



TECHNICAL DETAILS / Dettagli tecnici

Item TAE_130X130

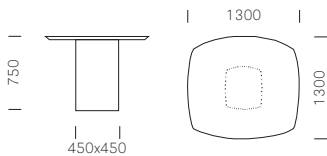

Item TAE_220X106

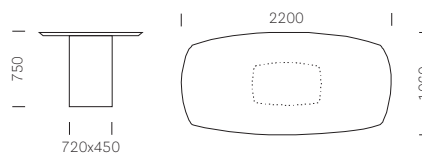

Glass top finish
Finitura ripiano in vetro



Solid laminate top finishes
Finiture ripiano in stratificato

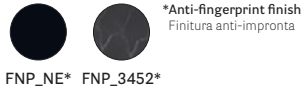
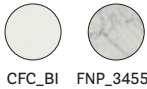

Frame finish
Finitura telaio



Frame finish
Finitura telaio

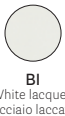

ARKI-BASE

Fixed tables / Tavoli fissi



| Frame Telaio | | Top Ripiano | Solid laminate top included Incluso ripiano in stratificato | | | | Steel top included Incluso ripiano in lamiera |
|------------------|-----------------------------|---------------------|--|-----------------------------|-----------------------------|-----------------------------|--|
| Item Articolo | Finish Finitura | Sizes Dimensioni | CFP_BI (mm 10) | FNP_NE (mm 10) | COP_3294 (mm 10) | COP_4543 (mm 10) | BI200E, GAE (mm 12) |
| ARK3 C | POWDER COATED Verniciato | Ø585 | - | - | - | - | € 333,50 € 273,00 |
| | | Ø590 | € 324,00 € 265,20 | € 305,00 € 249,60 | - | € 233,50 € 191,10 | - |
| | | Ø690 | € 378,50 € 310,05 | € 359,50 € 294,45 | - | € 274,50 € 224,90 | - |
| | | Ø700 | - | - | - | - | € 349,00 € 286,00 |
| | EC Corten | Ø590 | - | - | € 328,50 € 269,10 | - | - |
| | | Ø690 | - | - | € 370,00 € 302,90 | - | - |

Prices in bold are VAT included (VAT 22%)
I prezzi in grassetto si intendono IVA inclusa (IVA 22%)

TECHNICAL DETAILS / Dettagli tecnici

Item ARK3



Solid laminate top finishes Finiture ripiano in stratificato



*Anti-fingerprint finish
Finitura anti-impronta

Table base finishes Finiture basamento



Solid laminate top finish Finitura ripiano in stratificato



Table base finish Finitura basamento



Steel top finishes Finiture ripiano in lamiera



Table base finishes Finiture basamento



ARKI-BASE

Fixed tables / Tavoli fissi



| Frame Telaio | | Top Ripiano | Solid laminate top included Incluso ripiano in stratificato | | | | Steel top included Incluso ripiano in lamiera |
|------------------|-----------------------------|---------------------|--|-----------------------------|-----------------------------|-----------------------------|--|
| Item Articolo | Finish Finitura | Sizes Dimensioni | CFP_BI (mm 10) | FNP_NE (mm 10) | COP_3294 (mm 10) | COP_4543 (mm 10) | BI200E, GAE (mm 12) |
| ARK4 C | POWDER COATED Verniciato | 690x690 | € 408,50 € 334,75 | € 386,50 € 316,55 | - - | € 301,50 € 247,00 | - - |
| | | 700x700 | - - | - - | - - | - - | € 379,50 € 310,70 |
| | | 790x790 | € 461,00 € 377,65 | € 439,00 € 359,45 | - - | € 347,50 € 284,70 | - - |
| | | 800x800 | - - | - - | - - | - - | € 427,00 € 349,70 |
| | EC Corten | 690x690 | - - | - - | € 420,50 € 344,50 | - - | - - |
| | | 790x790 | - - | - - | € 466,50 € 382,20 | - - | - - |

Prices in bold are VAT included (VAT 22%)
I prezzi in grassetto si intendono IVA inclusa (IVA 22%)

TECHNICAL DETAILS / Dettagli tecnici

Item ARK4

690x690
700x700
790x790
800x800



Solid laminate top finishes Finiture ripiano in stratificato



*Anti-fingerprint finish
Finitura anti-impronta

CFP_BI COP_4543 FNP_NE*

Table base finishes Finiture basamento



BI200E TR NERO

Solid laminate top finish Finitura ripiano in stratificato



COP_3294

Table base finish Finitura basamento



EC

Steel top finishes Finiture ripiano in lamiera



BI200E GAE

Table base finishes Finiture basamento



BI200E GAE

ARKI-TABLE

Fixed tables / Tavoli fissi



| Frame Telaio | | | Solid laminate top included Incluso ripiano in stratificato | | | | | | | | | Melamine top included Incluso ripiano in nobilitato | |
|------------------|---------------------|--------------------------------|--|--|--|--|--|---|--|-------------------------------------|---|--|-------------------|
| Item Articolo | Sizes Dimensioni | Finish Finitura | CFC_BI (mm 6) white core anima bianca | CFC_BI (mm 6) white core anima bianca | COM_NE (mm 8) black core anima nera | FMP_NE (mm 12) plywood core anima in multistrati | FNP_NE (mm 6) black core anima nera | COM 527, 234, 623 (mm 6) 527, 234, 623 core/anima | COM 4511, 4512, 4517, 4519, 4529 (mm 10) brown core anima marrone | COM_527 (mm 6) 527 core/anima | COM 2810 (mm 12) black core anima nera | COM 4543 (mm 10) brown core anima marrone | NOB_NE (mm 10) |
| ARK200X100 | 2000X1000 | Powder coated Verniciato | € 1.659,00 € 1.359,80 | € 1.818,00 € 1.489,80 | € 1.564,00 € 1.281,80 | € 1.760,50 € 1.443,00 | € 1.897,00 € 1.554,80 | € 2.119,00 € 1.736,80 | € 2.119,00 € 1.736,80 | € 2.277,50 € 1.866,80 | € 2.277,50 € 1.866,80 | € 1.301,00 € 1.066,00 | |
| ARK240X100 | 2400X1000 | | € 1.722,50 € 1.411,80 | € 1.881,00 € 1.541,80 | € 1.627,50 € 1.333,80 | € 1.824,00 € 1.495,00 | € 2.634,50 € 2.159,30 | € 2.198,50 € 1.801,80 | € 2.198,50 € 1.801,80 | € 2.357,00 € 1.931,80 | € 2.357,00 € 1.931,80 | € 1.380,00 € 1.131,00 | |
| ARK240X120 | 2400X1200 | | € 1.841,50 € 1.509,30 | € 2.000,00 € 1.639,30 | € 1.746,50 € 1.431,30 | € 2.157,00 € 1.768,00 | € 2.753,50 € 2.256,80 | € 2.279,50 € 1.868,10 | € 2.279,50 € 1.868,10 | € 2.438,00 € 1.998,10 | € 2.438,00 € 1.998,10 | - | - |
| ARK300X100 | 3000X1000 | | € 1.954,00 € 1.601,60 | € 2.113,00 € 1.731,60 | € 1.827,50 € 1.497,60 | € 2.316,00 € 1.898,00 | € 2.874,00 € 2.355,60 | € 2.409,50 € 1.974,70 | € 2.409,50 € 1.974,70 | € 2.568,00 € 2.104,70 | € 2.568,00 € 2.104,70 | - | - |
| ARK300X120 | 3000X1200 | | € 2.025,50 € 1.660,10 | € 2.184,00 € 1.790,10 | € 1.898,50 € 1.556,10 | € 2.585,50 € 2.119,00 | € 2.945,50 € 2.414,10 | € 2.441,00 € 2.000,70 | € 2.441,00 € 2.000,70 | € 2.599,50 € 2.130,70 | € 2.599,50 € 2.130,70 | - | - |
| ARK360X120 | 3600X1200 | | € 2.492,00 € 2.042,30 | € 2.650,50 € 2.172,30 | € 2.333,50 € 1.912,30 | - | € 3.023,00 € 2.477,80 | € 2.906,00 € 2.381,60 | € 2.906,00 € 2.381,60 | € 3.064,50 € 2.511,60 | € 3.064,50 € 2.511,60 | - | - |

Prices in bold are VAT included (VAT 22%)
I prezzi in grassetto si intendono IVA inclusa (IVA 22%)

TECHNICAL DETAILS / Dettagli tecnici



Finishes / Finiture

Table top
Ripiano

Frame
Telaio

Frame under
the top
Telaio sotto il
ripiano

*Anti-fingerprint finish
Finitura anti-impronta

CFC_BI 4519

527 4511

234

623 2810

4543

4529 4512 4517 NOB_NE COM FMP/FNP*

BI100 BI100E

BE100 BE100E

BE200

GA GAE

TR

NERO

BI100 BI100E

BI100

NERO NPE

MG

NERO

ARKI-TABLE

Fixed tables - with cable management / Tavoli fissi - con canalina



CCO

Hole with black powder coated cable management and cover in the same material of the top.

Spacco per passaggio cavi con canalina verniciata nero e coperchio di chiusura dello stesso materiale del ripiano.



CC / CC60

| Frame Telaio | | | Cable management Canalina | Solid laminate top included Incluso ripiano in stratificato | | | | | | |
|---------------|------------------|--------------------------|---------------------------|--|--|---|--|---|--|--|
| Item Articolo | Sizes Dimensioni | Finish Finitura | | CFC_BI (mm 6) white core anima bianca | COM_NE (mm 8) black core anima nera | FMP_NE (mm 12) plywood core anima in multistrati | FNP_NE (mm 6) black core anima nera | COM 527, 234, 623 (mm 6) 527, 234, 623 core/anima COM 2810 (mm 12) black core anima nera | COM 4511, 4512, 4517, 4519, 4529 (mm 10) brown core anima marrone | COM 4543 (mm 10) brown core anima marrone |
| ARK240X120CC | 2400X1200 | Powder coated Verniciato | CC (42 mm) * | € 2.162,00 | € 2.067,00 | € 2.477,50 | € 3.074,00 | € 2.599,50 | € 2.599,50 | € 2.758,50 |
| | | | | € 1.771,90 | € 1.693,90 | € 2.030,60 | € 2.519,40 | € 2.130,70 | € 2.130,70 | € 2.260,70 |
| ARK300X120CC | 3000X1200 | | | € 2.346,00 | € 2.219,00 | € 2.906,00 | € 3.266,00 | € 2.761,50 | € 2.761,50 | € 2.920,00 |
| | | € 1.922,70 | € 1.818,70 | € 2.381,60 | € 2.676,70 | € 2.263,30 | € 2.263,30 | € 2.393,30 | | |
| ARK360X120CC | 3600X1200 | | | € 2.812,00 | € 2.653,50 | - | € 3.343,50 | € 3.226,00 | € 3.226,00 | € 3.385,00 |
| | | | | € 2.304,90 | € 2.174,90 | - | € 2.740,40 | € 2.644,20 | € 2.644,20 | € 2.774,20 |
| ARK240X120CCO | 2400X1200 | Powder coated Verniciato | CCO | € 2.317,50 | € 2.222,00 | € 2.633,00 | € 3.229,50 | € 2.755,00 | € 2.755,00 | € 2.913,50 |
| | | | | € 1.899,30 | € 1.821,30 | € 2.158,00 | € 2.646,80 | € 2.258,10 | € 2.258,10 | € 2.388,10 |
| ARK300X120CCO | 3000X1200 | | | € 2.850,50 | € 2.723,50 | € 3.410,00 | € 3.770,00 | € 3.266,00 | € 3.266,00 | € 3.424,50 |
| | | € 2.336,10 | € 2.232,10 | € 2.795,00 | € 3.090,10 | € 2.676,70 | € 2.676,70 | € 2.806,70 | | |
| ARK360X120CCO | 3600X1200 | | | € 3.316,50 | € 3.475,00 | - | € 3.848,00 | € 3.730,50 | € 3.730,50 | € 3.889,00 |
| | | | | € 2.718,30 | € 2.848,30 | - | € 3.153,80 | € 3.057,60 | € 3.057,60 | € 3.187,60 |

Prices in bold are VAT included (VAT 22%)
I prezzi in grassetto si intendono IVA inclusa (IVA 22%)

(* On request 60 mm width (CC60) cable management also available - same price
Disponibile a richiesta il tavolo con canalina larghezza 60 mm (CC60) allo stesso prezzo

TECHNICAL DETAILS / Dettagli tecnici

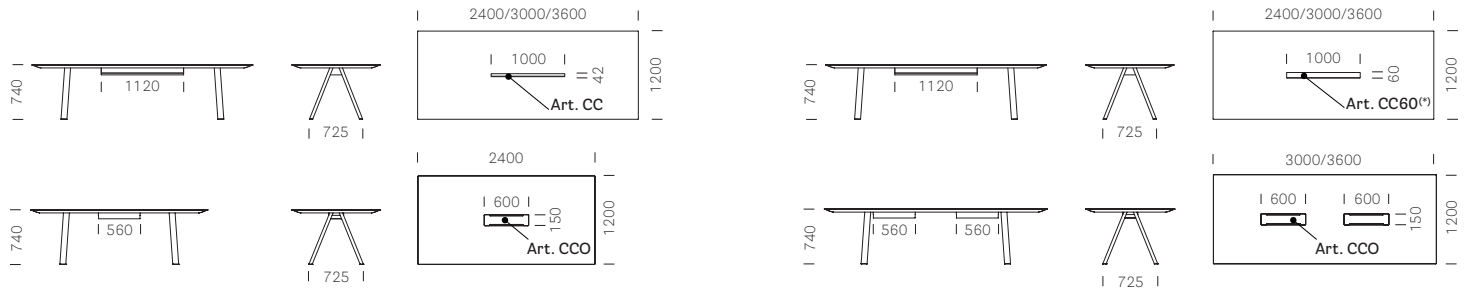

Finishes / Finiture

Table top Ripiano

Frame Telaio

Frame under the top Telaio sotto il ripiano

*Anti-fingerprint finish Finitura anti-impronta

COM FMP/FNP*

Colors and finishes shown: CFC_BI, 4519, 527, 4511, 234, 623, 2810, 4543, 4529, 4512, 4517, NERO, BI100, BE100, BE200, GA, TR, NERO, BI100, BI100, BI100, NERO, MG, NERO.

ARKI-TABLE

Adjustable tables / Tavoli regolabili in altezza



Double manual operation control placed under the table top
Doppio comando manuale posizionato sotto il ripiano



Bluetooth control placed under the table top
Comando Bluetooth posizionato sotto il ripiano

| Frame Telaio | | | Solid laminate top included Incluso ripiano in stratificato | | | | | | |
|---|------------------|--------------------------|--|--|---|--|---|--|--|
| Item Articolo | Sizes Dimensioni | Finish Finitura | CFC_BI (mm 6) white core anima bianca | COM_NE (mm 8) black core anima nera | FMP_NE (mm 12) plywood core anima in multistrati | FNP_NE (mm 6) black core anima nera | COM 527, 234, 623 (mm 6) 527, 234, 623 core/anima COM 2810 (mm 12) black core anima nera | COM 4511, 4512, 4517, 4519, 4529 (mm 10) brown core anima marrone | COM 4543 (mm 10) brown core anima marrone |
| Manual operation control / Comando manuale | | | | | | | | | |
| ARK200X100 REG | 2000X1000 | Powder coated Verniciato | € 3.879,50 € 3.179,80 | € 3.784,50 € 3.101,80 | € 3.981,00 € 3.263,00 | € 4.117,50 € 3.374,80 | € 4.339,50 € 3.556,80 | € 4.339,50 € 3.556,80 | € 4.498,00 € 3.686,80 |
| ARK240X100 REG | 2400X1000 | | € 4.197,00 € 3.439,80 | € 4.101,50 € 3.361,80 | € 4.298,50 € 3.523,00 | € 4.434,50 € 3.634,80 | € 4.656,50 € 3.816,80 | € 4.656,50 € 3.816,80 | € 4.815,50 € 3.946,80 |
| ARK300X100 REG | 3000X1000 | | € 4.514,00 € 3.699,80 | € 4.419,00 € 3.621,80 | € 4.615,50 € 3.783,00 | € 4.752,00 € 3.894,80 | € 4.974,00 € 4.076,80 | € 4.974,00 € 4.076,80 | € 5.132,50 € 4.206,80 |
| Bluetooth control / Comando Bluetooth | | | | | | | | | |
| ARK200X100 REG BT | 2000X1000 | Powder coated Verniciato | € 4.038,00 € 3.309,80 | € 3.943,00 € 3.231,80 | € 4.139,50 € 3.393,00 | € 4.276,00 € 3.504,80 | € 4.498,00 € 3.686,80 | € 4.498,00 € 3.686,80 | € 4.656,50 € 3.816,80 |
| ARK240X100 REG BT | 2400X1000 | | € 4.355,50 € 3.569,80 | € 4.260,00 € 3.491,80 | € 4.457,00 € 3.653,00 | € 4.593,50 € 3.764,80 | € 4.815,50 € 3.946,80 | € 4.815,50 € 3.946,80 | € 4.974,00 € 4.076,80 |
| ARK300X100 REG BT | 3000X1000 | | € 4.672,50 € 3.829,80 | € 4.577,50 € 3.751,80 | € 4.774,00 € 3.913,00 | € 4.910,50 € 4.024,80 | € 5.132,50 € 4.206,80 | € 5.132,50 € 4.206,80 | € 5.291,00 € 4.336,80 |

Prices in bold are VAT included (VAT 22%)
I prezzi in grassetto si intendono IVA inclusa (IVA 22%)

English plug version: surcharge **€ 32,00** (€ 26,00 vat not included) - to be mentioned in case of order
Versione con presa britannica: supplemento **€ 32,00** (€ 26,00 iva esclusa) - da specificare in caso di ordine

TECHNICAL DETAILS / Dettagli tecnici



Finishes / Finiture

Table top Ripiano

| | | | | | | | | | | | |
|--------|------|-----|------|-----|-----|------|------|------|------|------|--------------|
| | | | | | | | | | | | |
| CFC_BI | 4519 | 527 | 4511 | 234 | 623 | 2810 | 4543 | 4529 | 4512 | 4517 | COM FMP/FNP* |

*Anti-fingerprint finish
Finitura anti-impronta

Frame Telaio

| | | | | | |
|------|-------|-------|----|----|------|
| | | | | | |
| B100 | BE100 | BE200 | GA | TR | NERO |

Frame under the top
Telaio sotto il ripiano

| | | | | | |
|------|------|------|------|----|------|
| | | | | | |
| B100 | B100 | B100 | NERO | MG | NERO |

ARKI-TABLE wood

Fixed tables / Tavoli fissi



| Frame Telaio | | | Solid laminate top included Incluso ripiano in stratificato | | | |
|------------------|---------------------|--------------------|--|--|---|--|
| Item Articolo | Sizes Dimensioni | Finish Finitura | CFC_BI (mm 6) white core anima bianca | COM_NE (mm 8) black core anima nera | FMP_NE (mm 12) plywood core anima in multistrati | FNP_NE (mm 6) black core anima nera |
| ARKW200X100 | 2000X1000 | RS | € 1.911,50 € 1.566,50 | € 1.816,00 € 1.488,50 | € 2.014,50 € 1.651,00 | € 2.149,50 € 1.761,50 |
| ARKW240X100 | 2400X1000 | | € 1.975,00 € 1.618,50 | € 1.879,50 € 1.540,50 | € 2.078,00 € 1.703,00 | € 2.887,00 € 2.366,00 |
| ARKW240X120 | 2400X1200 | | € 2.094,00 € 1.716,00 | € 1.998,50 € 1.638,00 | € 2.411,00 € 1.976,00 | € 3.005,50 € 2.463,50 |
| ARKW300X100 | 3000X1000 | | € 2.206,50 € 1.808,30 | € 2.079,50 € 1.704,30 | € 2.569,50 € 2.106,00 | € 3.126,50 € 2.562,30 |
| ARKW300X120 | 3000X1200 | | € 2.277,50 € 1.866,80 | € 2.151,00 € 1.762,80 | € 2.839,00 € 2.327,00 | € 3.197,50 € 2.620,80 |
| ARKW360X120 | 3600X1200 | | € 2.744,00 € 2.249,00 | € 2.585,50 € 2.119,00 | - - | € 3.275,50 € 2.684,50 |

Prices in bold are VAT included (VAT 22%)
I prezzi in grassetto si intendono IVA inclusa (IVA 22%)

TECHNICAL DETAILS / Dettagli tecnici



Finishes / Finiture

**Table top
Ripiano**

CFC_BI COM FMP/FNP*
*Anti-fingerprint finish
Finitura anti-impronta

**Frame
Telaio**

RS RS

**Frame under
the top
Telaio sotto il
ripiano**

BI100 NERO

ARKI-TABLE wood

Fixed tables - with cable management / Tavoli fissi - con canalina



CCO

Hole with black powder coated cable management and cover in the same material of the top.
Spacco per passaggio cavi con canalina verniciata nero e coperchio di chiusura dello stesso materiale del ripiano.



CC / CC60

| Frame Telaio | | | Cable management Canalina | Solid laminate top included Incluso ripiano in stratificato | | | |
|----------------|------------------|-----------------|---------------------------|--|--|---|--|
| Item Articolo | Sizes Dimensioni | Finish Finitura | | CFC_BI (mm 6) white core anima bianca | COM_NE (mm 8) black core anima nera | FMP_NE (mm 12) plywood core anima in multistrati | FNP_NE (mm 6) black core anima nera |
| ARKW240X120CC | 2400X1200 | RS | CC (42 mm) * | € 2.414,00 € 1.978,60 | € 2.319,00 € 1.900,60 | € 2.731,50 € 2.238,60 | € 3.326,00 € 2.726,10 |
| ARKW300X120CC | 3000X1200 | | | € 2.598,00 € 2.129,40 | € 2.471,00 € 2.025,40 | € 3.159,50 € 2.589,60 | € 3.518,00 € 2.883,40 |
| ARKW360X120CC | 3600X1200 | | | € 3.064,50 € 2.511,60 | € 2.906,00 € 2.381,60 | - | € 3.595,50 € 2.947,10 |
| ARKW240X120CCO | 2400X1200 | | CCO | € 2.569,50 € 2.106,00 | € 2.474,50 € 2.028,00 | € 2.887,00 € 2.366,00 | € 3.481,50 € 2.853,50 |
| ARKW300X120CCO | 3000X1200 | | | € 3.102,50 € 2.542,80 | € 2.975,50 € 2.438,80 | € 3.664,00 € 3.003,00 | € 4.022,50 € 3.296,80 |
| ARKW360X120CCO | 3600X1200 | | | € 3.568,50 € 2.925,00 | € 3.410,00 € 2.795,00 | - | € 4.100,00 € 3.360,50 |

Prices in bold are VAT included (VAT 22%)
I prezzi in grassetto si intendono IVA inclusa (IVA 22%)

(* On request 60 mm width (CC60) cable management also available - same price
Disponibile a richiesta il tavolo con canalina larghezza 60 mm (CC60) allo stesso prezzo

TECHNICAL DETAILS / Dettagli tecnici

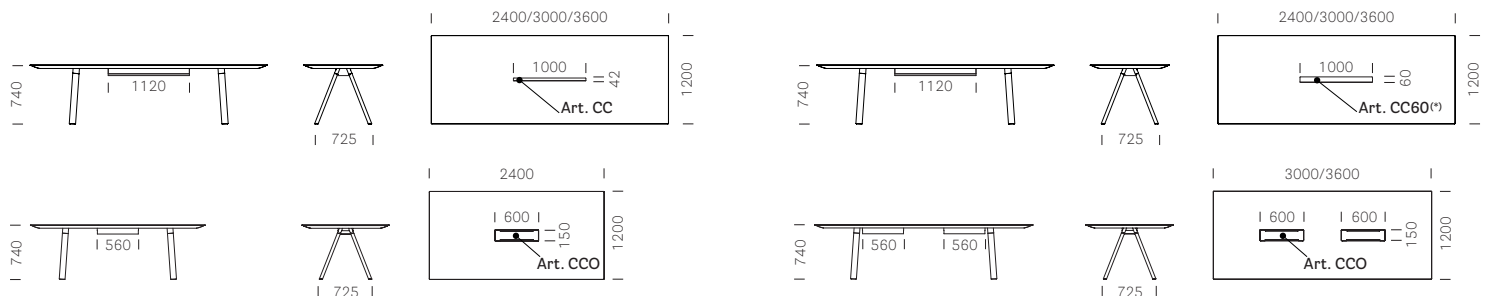

Finishes / Finiture

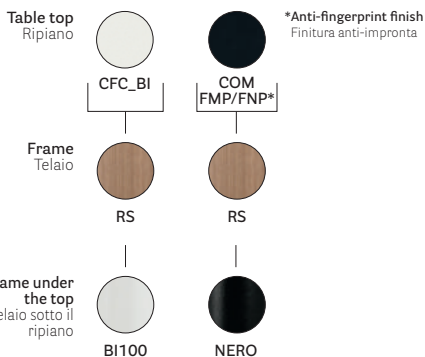

ARKI-TABLE

Fixed tables / Tavoli fissi



| Frame Telaio | | | Solid laminate top included Incluso ripiano in stratificato | | | | | | | |
|------------------|---------------------|--------------------------------|--|---|---|--|---|---|--|--|
| Item Articolo | Sizes Dimensioni | Finish Finitura | CFC_BI (mm 12) white core anima bianca | CFC_BI (mm 12) white core anima bianca | COM_NE (mm 12) black core anima nera | FMP_NE (mm 12) plywood core anima in multistrati | FNP_NE (mm 10) black core anima nera | COM 2810 (mm 12) black core anima nera | COM 4511, 4512, 4517, 4519, 4529 (mm 10) brown core anima marrone | COM 4543 (mm 10) brown core anima marrone |
| ARK139X139 | 1384X1384 | Powder coated Verniciato | € 1.838,50 € 1.506,70 | € 1.997,00 € 1.636,70 | € 1.634,00 € 1.339,00 | € 1.805,00 € 1.479,40 | € 1.917,50 € 1.571,70 | € 1.605,50 € 1.315,60 | € 1.729,00 € 1.417,00 | € 1.887,50 € 1.547,00 |
| ARKD139 | Ø 1384 | | € 1.818,00 € 1.489,80 | € 1.976,50 € 1.619,80 | € 1.615,00 € 1.323,40 | € 1.784,50 € 1.462,50 | € 1.897,00 € 1.554,80 | € 1.584,50 € 1.298,70 | € 1.708,50 € 1.400,10 | € 1.867,00 € 1.530,10 |
| ARKD159 | Ø 1590 | | € 2.133,50 € 1.748,50 | € 2.292,00 € 1.878,50 | € 1.738,50 € 1.424,80 | - | € 2.133,50 € 1.748,50 | € 1.724,00 € 1.413,10 | € 1.895,50 € 1.553,50 | € 2.054,00 € 1.683,50 |
| ARKW139X139 | 1384X1384 | RS | € 2.090,50 € 1.713,40 | - | € 1.886,00 € 1.545,70 | € 2.057,50 € 1.686,10 | € 2.170,00 € 1.778,40 | - | - | - |
| ARKWD139 | Ø 1384 | | € 2.070,00 € 1.696,50 | - | € 1.867,00 € 1.530,10 | € 2.036,50 € 1.669,20 | € 2.149,50 € 1.761,50 | - | - | - |
| ARKWD159 | Ø 1590 | | € 2.385,50 € 1.955,20 | - | € 1.990,50 € 1.631,50 | - | € 2.385,50 € 1.955,20 | - | - | - |

Prices in bold are VAT included (VAT 22%)

I prezzi in grassetto si intendono IVA inclusa (IVA 22%)

TECHNICAL DETAILS / Dettagli tecnici

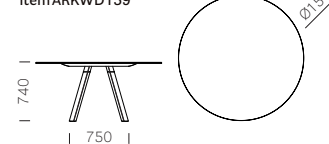
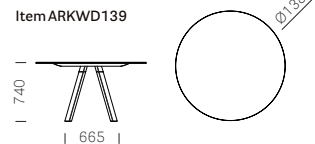
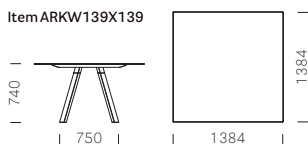
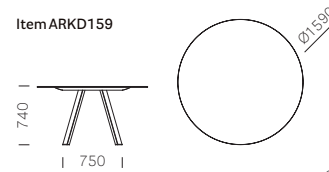
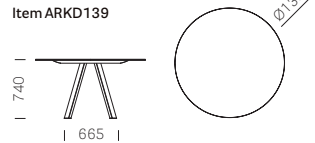
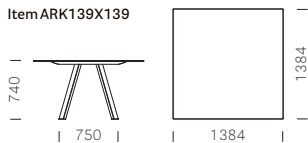

Finishes / Finiture

Table top
Ripiano

Frame
Telaio

Frame under the top
Telaio sotto il ripiano

*Anti-fingerprint finish
Finitura anti-impronta

*Anti-fingerprint finish
Finitura anti-impronta

ARKI-TABLE

Fixed tables / Tavoli fissi



| Frame Telaio | | | Solid laminate top included Incluso ripiano in stratificato | | | | | | | | | |
|------------------|---------------------|-----------------------------|--|--|--|--|--|--|---|-------------------------------------|--|--|
| Item Articolo | Sizes Dimensioni | Finish Finitura | Cable management Canalina | CFC_BI (mm 6) white core anima bianca | CFC_BI (mm 6) white core anima bianca | COM_NE (mm 8) black core anima nera | FMP_NE (mm 12) plywood core anima in multistrati | FNP_NE (mm 6) black core anima nera | COM 527, 234, 623 (mm 6) 527, 234, 623 core/anima | COM 527 (mm 6) 527 core/anima | COM 4511, 4512, 4517, 4519, 4529 (mm 10) brown core anima marrone | COM 4543 (mm 10) brown core anima marrone |
| ARK107_200X79 | 2000X790 | Powder coated Verniciato | | € 1.818,00 | € 1.976,50 | € 1.722,50 | € 1.919,50 | € 2.055,50 | € 2.277,50 | € 2.436,50 | € 2.277,50 | € 2.436,50 |
| ARK107_200X79CC | | | CC (42 mm) * | € 1.489,80 | € 1.619,80 | € 1.411,80 | € 1.573,00 | € 1.684,80 | € 1.866,80 | € 1.996,80 | € 1.866,80 | € 1.996,80 |
| | | | | € 2.138,00 | - | € 2.043,00 | € 2.239,50 | € 2.376,00 | € 2.598,00 | - | € 2.598,00 | € 2.756,50 |
| | | | | € 1.752,40 | - | € 1.674,40 | € 1.835,60 | € 1.947,40 | € 2.129,40 | - | € 2.129,40 | € 2.259,40 |

Prices in bold are VAT included (VAT 22%)
I prezzi in grassetto si intendono IVA inclusa (IVA 22%)

(*) On request 60 mm width (CC60) cable management also available - same price
Disponibile a richiesta il tavolo con canalina larghezza 60 mm (CC60) allo stesso prezzo

TECHNICAL DETAILS / Dettagli tecnici

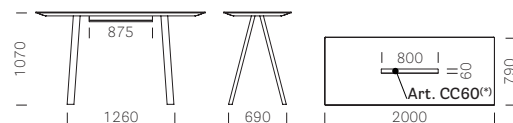
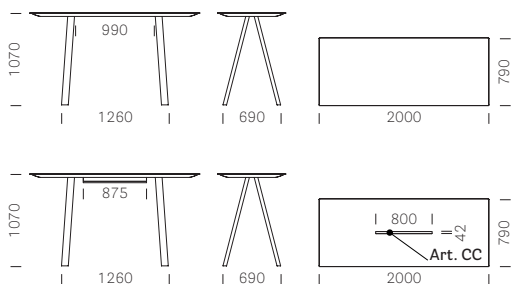

| | | Finishes / Finiture | | | | | | | | | | | |
|--|--|---------------------|-----------------|-------|-------------|-----|------|------|------|------|------|------|-----------------|
| Table top Ripiano | | CFC_BI | 4519 | 527 | 4511 | 234 | 623 | 2810 | 4543 | 4529 | 4512 | 4517 | COM FMP/FNP* |
| Frame Telaio | | BI100 BI100E | BE100 BE100E | BE200 | GA GAE | TR | NERO | | | | | | |
| Frame under the top Telaio sotto il ripiano | | BI100 BI100E | BI100 BI100E | BI100 | NERO NPE | MG | NERO | | | | | | |

ARKI-TABLE wood

Fixed tables / Tavoli fissi



| Frame Telaio | | | Solid laminate top included Incluso ripiano in stratificato | | | | |
|------------------|---------------------|--------------------|--|--|--|---|--|
| Item Articolo | Sizes Dimensioni | Finish Finitura | Cable management Canalina | CFC_BI (mm 6) white core anima bianca | COM_NE (mm 8) black core anima nera | FMP_NE (mm 12) plywood core anima in multistrati | FNP_NE (mm 6) black core anima nera |
| ARKW107_200X79 | 2000X790 | RS | | € 2.198,50 € 1.801,80 | € 2.103,50 € 1.723,80 | € 2.300,00 € 1.885,00 | € 2.436,50 € 1.996,80 |
| ARKW107_200X79CC | | | CC (42 mm) * | € 2.519,00 € 2.064,40 | € 2.423,50 € 1.986,40 | € 2.620,50 € 2.147,60 | € 2.756,50 € 2.259,40 |

Prices in bold are VAT included (VAT 22%)
I prezzi in grassetto si intendono IVA inclusa (IVA 22%)

(*) On request 60 mm width (CC60) cable management also available - same price
Disponibile a richiesta il tavolo con canalina larghezza 60 mm (CC60) allo stesso prezzo

TECHNICAL DETAILS / Dettagli tecnici

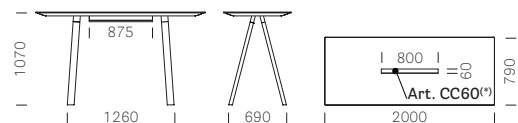
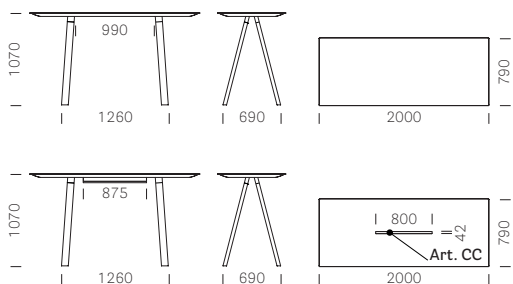

Finishes / Finiture

**Table top
Ripiano**

- CFC_BI
- COM FMP/FNP* *Anti-fingerprint finish
Finitura anti-impronta

**Frame
Telaio**

- RS
- RS

**Frame under
the top
Telaio sotto il
ripiano**

- BI100
- NERO

ARKI-TABLE - ARK5

Fixed tables / Tavoli fissi



| Frame Telaio | | Top Ripiano | Solid laminate top included Incluso ripiano in stratificato | | | | | |
|---------------|----------------------|------------------|--|---|---|---|---|--|
| Item Articolo | Finish Finitura | Sizes Dimensioni | CFP_BI (mm 12) white core anima bianca | CFP_BI (mm 12) white core anima bianca | FNP_NE (mm 10) black core anima nera | COP_2810 (mm 12) black core anima nera | COP_2810 (mm 12) black core anima nera | COP_4543 (mm 10) brown core anima marrone |
| ARK5_79X79 | TR/NERO/ BI100/GA | 790X790 | € 722,00 € 591,50 | € 817,00 € 669,50 | € 642,00 € 525,85 | € 547,50 € 448,50 | € 642,50 € 526,50 | € 550,50 € 451,10 |
| ARK5_89X89 | | 890X890 | € 843,00 € 690,95 | € 938,50 € 768,95 | € 722,50 € 592,15 | € 626,50 € 513,50 | € 722,00 € 591,50 | € 620,50 € 508,30 |
| ARK5_D_99 | | Ø990 | € 926,50 € 759,20 | € 1.021,50 € 837,20 | € 844,00 € 691,60 | € 661,50 € 542,10 | € 757,00 € 620,10 | € 663,00 € 543,40 |
| ARK5_D109 | | Ø1090 | € 1.134,00 € 929,50 | € 1.229,50 € 1.007,50 | € 1.082,00 € 886,60 | € 856,50 € 702,00 | € 952,00 € 780,00 | € 879,00 € 720,20 |
| ARK5_D119 | | Ø1190 | € 1.287,50 € 1.054,95 | € 1.382,50 € 1.132,95 | € 1.155,50 € 947,05 | € 907,50 € 743,60 | € 1.002,50 € 821,60 | € 932,00 € 763,75 |
| ARK5_D129 | | Ø1290 | € 1.698,00 € 1.391,65 | € 1.793,00 € 1.469,65 | € 1.216,50 € 997,10 | € 1.063,50 € 871,65 | € 1.159,00 € 949,65 | € 1.041,50 € 853,45 |

Prices in bold are VAT included (VAT 22%)
I prezzi in grassetto si intendono IVA inclusa (IVA 22%)

TECHNICAL DETAILS / Dettagli tecnici

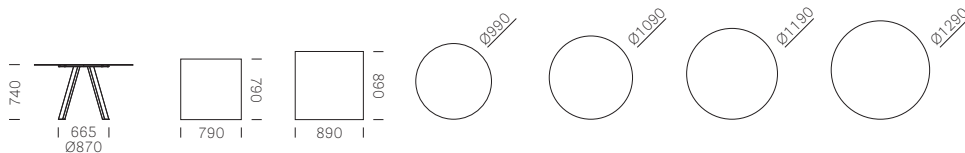

Solid laminate tops Ripiani in stratificato



Powder-coated frame Telaio in acciaio verniciato

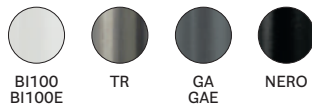

ARKI-TABLE - ARKW5 wood

Fixed tables / Tavoli fissi



| Frame Telaio | | Top Ripiano | Solid laminate top included Incluso ripiano in stratificato | |
|------------------|--------------------|---------------------|--|---|
| Item Articolo | Finish Finitura | Sizes Dimensioni | CFP_BI (mm 12) white core anima bianca | FNP_NE (mm 10) black core anima nera |
| ARKW5_79X79 | RS | 790X790 | € 880,50 € 721,50 | € 800,50 € 655,85 |
| ARKW5_89X89 | | 890X890 | € 1.002,00 € 820,95 | € 881,50 € 722,15 |
| ARKW5_D_99 | | Ø990 | € 1.085,00 € 889,20 | € 1.002,50 € 821,60 |
| ARKW5_D109 | | Ø1090 | € 1.293,00 € 1.059,50 | € 1.240,50 € 1.016,60 |
| ARKW5_D119 | | Ø1190 | € 1.446,00 € 1.184,95 | € 1.314,50 € 1.077,05 |
| ARKW5_D129 | | Ø1290 | € 1.856,50 € 1.521,65 | € 1.376,00 € 1.127,75 |

Prices in bold are VAT included (VAT 22%)
I prezzi in grassetto si intendono IVA inclusa (IVA 22%)

TECHNICAL DETAILS / Dettagli tecnici

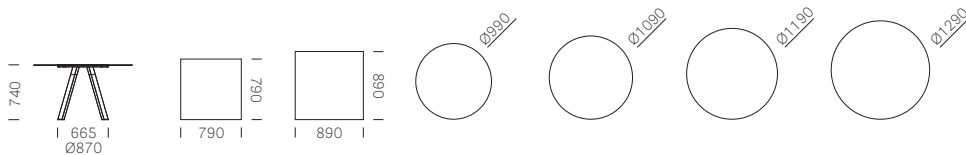

Solid laminate tops

Ripiani in stratificato



*Anti-fingerprint finish
Finitura anti-impronta

Bleached oak frame

Telaio in rovere sbiancato



BABILA table

Fixed tables / Tavoli fissi



| Frame Telaio | | | Cable management Canalina | Solid laminate top included Incluso ripiano in stratificato | | | |
|------------------|---------------------|--------------------|--|--|---------------------------------|---------------------------------|---------------------------------|
| Item Articolo | Sizes Dimensioni | Finish Finitura | | CFC_BI (mm 6) | FNP_NE (mm 6) | FNP_3452 (mm 6) | FNP_3455 (mm 6) |
| TBA_90X90 | 900X900 | FR/AN/N1 | Without cable management Senza canalina | € 1.610,00 € 1.319,50 | € 1.507,00 € 1.235,00 | € 1.538,50 € 1.261,00 | € 1.665,50 € 1.365,00 |
| TBA D139 | Ø1390 | | | € 2.008,00 € 1.645,80 | € 2.087,50 € 1.710,80 | - | - |
| TBA160X90 | 1590X900 | | | € 1.729,00 € 1.417,00 | € 1.729,00 € 1.417,00 | € 2.078,00 € 1.703,00 | € 2.363,50 € 1.937,00 |
| TBA200X90 | 2000X900 | | | € 1.935,00 € 1.586,00 | € 1.982,50 € 1.625,00 | € 2.062,00 € 1.690,00 | € 2.379,00 € 1.950,00 |
| TBA200X100 | 2000X1000 | | | € 1.951,00 € 1.599,00 | € 1.998,50 € 1.638,00 | € 2.078,00 € 1.703,00 | € 2.395,00 € 1.963,00 |
| TBA240X100 | 2400X1000 | | | € 2.014,50 € 1.651,00 | € 2.546,00 € 2.086,50 | € 3.021,50 € 2.476,50 | € 3.592,50 € 2.944,50 |
| TBA300X100 | 3000X1000 | | | € 2.664,50 € 2.184,00 | € 3.109,00 € 2.548,00 | € 3.584,50 € 2.938,00 | € 4.155,50 € 3.406,00 |
| TBA200X100CC | 2000X1000 | | With cable management Con canalina | € 2.271,50 € 1.861,60 | € 2.319,00 € 1.900,60 | € 2.398,50 € 1.965,60 | € 2.715,50 € 2.225,60 |
| TBA240X100CC | 2400X1000 | | Width/Larghezza: 42 mm (item CC) | € 2.335,00 € 1.913,60 | € 2.866,00 € 2.349,10 | € 3.342,00 € 2.739,10 | € 3.913,00 € 3.207,10 |

Prices in bold are VAT included (VAT 22%)
I prezzi in grassetto si intendono IVA inclusa (IVA 22%)

(*) On request 60 mm width (CC60) cable management also available - same price
Disponibile a richiesta il tavolo con canalina larghezza 60 mm (CC60) allo stesso prezzo

TECHNICAL DETAILS / Dettagli tecnici

Item TBA_90X90

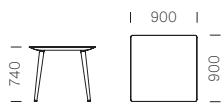

Item TBAD139

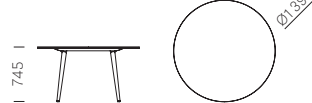

Item TBA160/200X90



Item TBA200/240X100CC



Item TBA200/240/300X100



Item TBA200/240X100CC60



Solid laminate tops Ripiani in stratificato

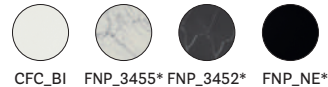

*Anti-fingerprint finish
Finitura anti-impronta

Ash frame Telaio in frassino



BUDDY

Coffee tables / Tavolini



| Item Articolo | Frame Telaio | Sizes Dimensioni | Finish Finitura | Solid laminate top included Incluso ripiano in stratificato | | | | |
|------------------|-----------------|---------------------|--------------------|--|-----------------------------|-----------------------------|-----------------------------|-----------------------------|
| | | | | CFP_BI (mm 10) | FNP_NE (mm 10) | COP_4543 (mm 10) | FNP_3452 (mm 10) | FNP_3455 (mm 10) |
| BDT_59X59X26 | | 590X590X250h | BI200 / BI200E | € 351,00 € 287,30 | - | - | - | € 431,50 € 353,60 |
| | | | SA100E | - | - | € 293,50 € 240,50 | - | - |
| BDT_59X59X32 | | 590X590X310h | NEF | - | € 363,50 € 297,70 | - | € 368,00 € 301,60 | € 431,50 € 353,60 |
| | | | OA | € 473,00 € 387,40 | € 517,50 € 423,80 | - | € 514,00 € 421,20 | € 585,50 € 479,70 |
| BDT_79X79X26 | | 790X790X250h | BI200 / BI200E | € 496,50 € 406,90 | - | - | - | € 642,50 € 526,50 |
| | | | SA100E | - | - | € 423,50 € 347,10 | - | - |
| BDT_79X79X32 | | 790X790X310h | NEF | - | € 463,50 € 379,60 | - | € 508,00 € 416,00 | € 642,50 € 526,50 |
| | | | OA | € 634,50 € 520,00 | € 649,00 € 531,70 | - | € 693,50 € 568,10 | € 828,00 € 678,60 |

Prices in bold are vat included (IVA 22%)
I prezzi in grassetto si intendono iva inclusa (22%)

TECHNICAL DETAILS / Dettagli tecnici

Item BDT_59X59X26

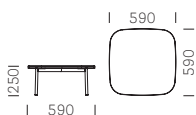

Item BDT_59X59X32

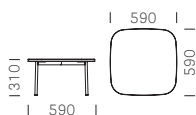

Item BDT_79X79X26

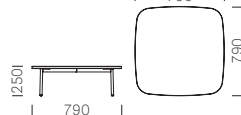

Item BDT_79X79X32

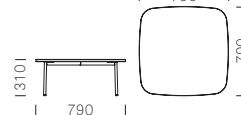

Solid laminate top finishes
Finiture ripiano in stratificato



*Anti-fingerprint finish
Finitura anti-impronta

Frame finishes
Finiture telaio



BUDDY marble

Coffee tables / Tavolini



| Item Articolo | Frame Telaio | Finish Finitura | Marble top included Incluso ripiano in marmo | | | | Composite marble top included Incluso ripiano in agglomerato di marmo | |
|------------------------------|-----------------|--------------------|---|-------------------------------|-----------------------------|-------------------------------|--|-------------------------------|
| | | | MBA (mm 20) | MED (mm 20) | MGC (mm 20) | MVG (mm 20) | MFP (mm 12) | MBR (mm 12) |
| BDT_59X59X26 BDT_59X59X32 | 590X590X260h | BI200E | - | - | - | - | € 447,50* € 366,60* | - |
| | | SA100E | - | - | - | - | - | € 447,50* € 366,60* |
| | 590X590X320h | NEF | € 672,50 € 551,20 | € 672,50 € 551,20 | € 672,50 € 551,20 | € 672,50 € 551,20 | - | - |
| | | OA | € 826,50 € 677,30 | € 826,50 € 677,30 | - | € 826,50 € 677,30 | - | - |
| BDT_79X79X26 BDT_79X79X32 | 790X790X260h | BI200E | - | - | - | - | € 707,50* € 579,80* | - |
| | | SA100E | - | - | - | - | - | € 707,50* € 579,80* |
| | 790X790X320h | NEF | € 963,00 € 789,10 | € 963,00 € 789,10 | € 963,00 € 789,10 | € 963,00 € 789,10 | - | - |
| | | OA | € 1.148,50 € 941,20 | € 1.148,50 € 941,20 | - | € 1.148,50 € 941,20 | - | - |

*Price includes a black compact laminate support 12 mm thickness
Il prezzo include un ripiano di supporto in stratificato nero spessore 12 mm

Prices in bold are vat included (IVA 22%)
I prezzi in grassetto si intendono iva inclusa (22%)

TECHNICAL DETAILS / Dettagli tecnici

Item BDT_59X59X26*

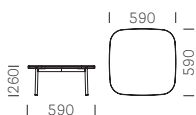

Item BDT_59X59X32*

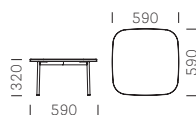

Item BDT_79X79X26*

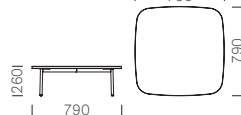

Item BDT_79X79X32*

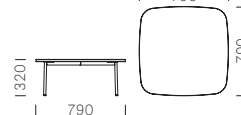

* Table height increases of 1 cm for composite marble top versions
L'altezza del tavolo aumenta di 1 cm per le versioni con ripiano in agglomerato di marmo

Marble top finishes Finiture ripiano marmo



Composite marble top finishes Finiture ripiano in agglomerato di marmo

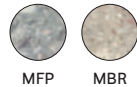

Frame finishes Finiture telaio



CODE

Coffee tables / Tavolini



| Item Articolo | Frame Telaio | | Solid laminate top included Incluso ripiano in stratificato | | |
|------------------|--|--------------------|--|-------------------|--|
| | Sizes Dimensioni | Finish Finitura | FNP_NE (mm 10) | CFP_BI (mm 10) | VAT NOT INCLUDED Iva esclusa 22% |
| CODE_40X40X30 | 400X400X300h | NEF | € 225,50 | - | € 184,60 |
| | | BI100E | - | € 265,00 | € 217,10 |
| CODE_40X40X60 | 400X400X600h | NEF | € 257,00 | - | € 210,60 |
| | | BI100E | - | € 297,00 | € 243,10 |
| CODE_50X50X36 | 500X500X360h | NEF | € 297,00 | - | € 243,10 |
| | | BI100E | - | € 344,50 | € 282,10 |
| CODE_59X59X42 | 590X590X420h | NEF | € 357,00 | - | € 292,50 |
| | | BI100E | - | € 404,50 | € 331,50 |
| CODE_119X59X30 | 1190X590X300h | NEF | € 625,00 | - | € 512,20 |
| | | BI100E | - | € 680,50 | € 557,70 |
| SET_CODE | 400X400X300h 500X500X360h 590X590X420h | NEF | € 879,00 | - | € 720,20 |
| | | BI100E | - | € 1.013,50 | € 830,70 |

TECHNICAL DETAILS / Dettagli tecnici

Item CODE_40X40X30

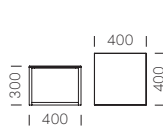

Item CODE_40X40X60

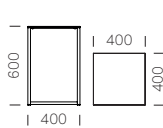

Item CODE_50X50X36

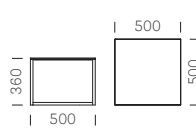

Item CODE_59X59X42

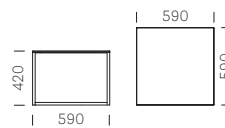

Item CODE_119X59X30

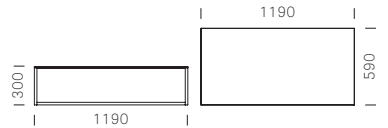

Solid laminate top finishes Finiture ripiano in stratificato



Frame finishes Finiture telaio



CODE marble

Coffee tables / Tavolini



| Item Articolo | Frame Telaio Sizes Dimensioni | Finish Finitura | Marble top included Incluso ripiano in marmo | | | | VAT NOT INCLUDED Iva esclusa 22% |
|------------------|--|--------------------|---|----------------|----------------|----------------|--|
| | | | MBA (mm 20) | MED (mm 20) | MGC (mm 20) | MVG (mm 20) | |
| CODE_40X40X30 | 400X400X300h | BI100 | € 474,50 | - | - | - | € 388,70 |
| | | MG | - | € 474,50 | - | - | |
| | | NEF | - | - | € 474,50 | € 474,50 | |
| CODE_40X40X60 | 400X400X600h | BI100 | € 506,00 | - | - | - | € 414,70 |
| | | MG | - | € 506,00 | - | - | |
| | | NEF | - | - | € 506,00 | € 506,00 | |
| CODE_50X50X36 | 500X500X360h | BI100 | € 555,50 | - | - | - | € 455,00 |
| | | MG | - | € 555,50 | - | - | |
| | | NEF | - | - | € 555,50 | € 555,50 | |
| CODE_59X59X42 | 590X590X420h | BI100 | € 665,00 | - | - | - | € 544,70 |
| | | MG | - | € 665,00 | - | - | |
| | | NEF | - | - | € 665,00 | € 665,00 | |
| CODE_119X59X30 | 1190X590X300h | BI100 | € 1.134,00 | - | - | - | € 929,50 |
| | | MG | - | € 1.134,00 | - | - | |
| | | NEF | - | - | € 1.134,00 | € 1.134,00 | |

TECHNICAL DETAILS / Dettagli tecnici

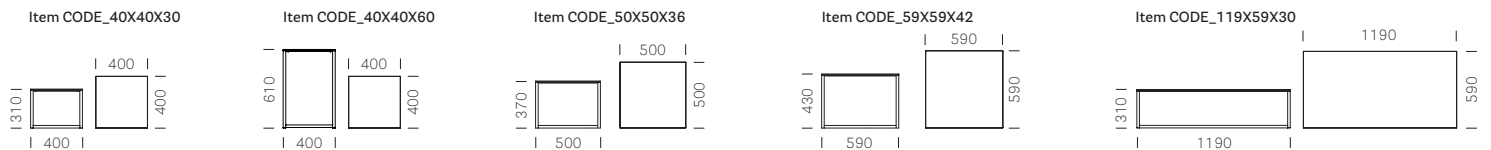

Marble top finishes
Finiture ripiano in marmo

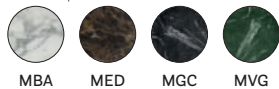

Frame finishes
Finiture telaio



ELINOR table

Fixed tables / Tavoli fissi



| Item Articolo | Frame Telaio Sizes Dimensioni | Finish Finitura | Solid laminate top included Incluso ripiano in stratificato | | | |
|------------------|--|--------------------|--|---------------------------------|---------------------------------|---------------------------------|
| | | | CFP_BI (mm 6) | FNP_NE (mm 6) | FNP_3452 (mm 6) | FNP_3455 (mm 6) |
| ELN150X150 | 1500x1500 | C130+C141 | € 4.932,50 € 4.043,00 | € 4.932,50 € 4.043,00 | - | - |
| | | H20+H108 | € 4.996,00 € 4.095,00 | € 4.996,00 € 4.095,00 | - | - |
| | | P | € 5.599,00 € 4.589,00 | € 5.599,00 € 4.589,00 | - | - |
| ELN200X110 | 2000x1100 | C130+C141 | € 4.766,00 € 3.906,50 | € 4.845,50 € 3.971,50 | € 4.925,00 € 4.036,50 | € 5.305,50 € 4.348,50 |
| | | H20+H108 | € 4.829,50 € 3.958,50 | € 4.909,00 € 4.023,50 | € 4.988,00 € 4.088,50 | € 5.369,00 € 4.400,50 |
| | | P | € 5.432,50 € 4.452,50 | € 5.511,50 € 4.517,50 | € 5.591,00 € 4.582,50 | € 5.971,50 € 4.894,50 |
| ELN260X110 | 2600x1100 | C130+C141 | € 5.741,50 € 4.706,00 | € 5.900,00 € 4.836,00 | € 6.059,00 € 4.966,00 | € 6.598,00 € 5.408,00 |
| | | H20+H108 | € 5.805,00 € 4.758,00 | € 5.963,50 € 4.888,00 | € 6.122,00 € 5.018,00 | € 6.661,50 € 5.460,00 |
| | | P | € 6.407,50 € 5.252,00 | € 6.566,50 € 5.382,00 | € 6.725,00 € 5.512,00 | € 7.264,00 € 5.954,00 |
| ELN300X110 | 3000x1100 | C130+C141 | € 6.225,50 € 5.102,50 | € 6.384,00 € 5.232,50 | € 6.542,50 € 5.362,50 | € 7.161,00 € 5.869,50 |
| | | H20+H108 | € 6.288,50 € 5.154,50 | € 6.447,50 € 5.284,50 | € 6.606,00 € 5.414,50 | € 7.224,50 € 5.921,50 |
| | | P | € 6.891,50 € 5.648,50 | € 7.050,00 € 5.778,50 | € 7.208,50 € 5.908,50 | € 7.827,00 € 6.415,50 |

Prices in bold are VAT included (VAT 22%)
I prezzi in grassetto si intendono IVA inclusa (IVA 22%)

TECHNICAL DETAILS / Dettagli tecnici

Item ELN150X150

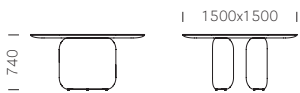

Item ELN200/260/300X110

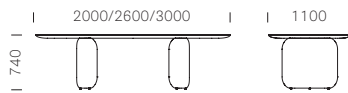
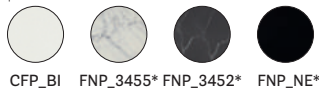
Solid laminate top
Ripiani in stratificato*Anti-fingerprint finish
Finitura anti-impronta

For fabrics see page 306
Per i tessuti si veda a p. 306

ELLIOT

Fixed tables / Tavoli fissi



5470



5475

TECHNICAL DETAILS / Dettagli tecnici

Item 5470



Item 5475



| Item Articolo | Frame Telaio | Top Ripiano | Solid laminate top included Incluso ripiano in stratificato | | Steel top included Incluso ripiano in lamiera | | Marble top included Incluso ripiano in marmo | Composite marble top included Incluso ripiano in agglomerato di marmo |
|------------------|---|-----------------------------|--|-----------------------------|--|---|---|--|
| | | | Sizes Dimensioni | CFC_BI (mm 10) | FNP_NE (mm 10) | BI200E, VE100E, GI100E, AZ100E, RO200E (mm 12) | NERO (mm 12) | MBA MGC (mm 20) |
| 5470 C | POWDER COATED Verniciato | Ø690 | € 423,00 € 346,45 | € 399,00 € 326,95 | - | - | - | - |
| | | Ø700 | - | - | € 393,50 € 322,40 | € 370,00 € 302,90 | - | - |
| | POLISHED ALUMINIUM Alluminio lucidato | Ø690 | € 439,00 € 359,45 | € 439,00 € 359,45 | - | - | - | - |
| | ANTIQUÉ BRASS / TITANIUM Ottone anticato / Titanio | Ø690 | € 542,00 € 443,95 | € 542,00 € 443,95 | - | - | - | - |
| 5475 C | POWDER COATED Verniciato | Ø700 | - | - | - | - | € 758,50 € 621,40 | € 672,50 € 551,20 |
| | | Ø890 | € 580,00 € 475,15 | € 548,00 € 449,15 | - | - | - | - |
| | | 890x890 | € 580,00 € 475,15 | € 548,00 € 449,15 | - | - | - | - |
| | POLISHED ALUMINIUM Alluminio lucidato | Ø700 | - | - | - | - | € 806,00 € 660,40 | - |
| | | Ø890 | € 596,00 € 488,15 | € 596,00 € 488,15 | - | - | - | - |
| | | 890x890 | € 596,00 € 488,15 | € 596,00 € 488,15 | - | - | - | - |
| | ANTIQUÉ BRASS / TITANIUM Ottone anticato / Titanio | Ø700 | - | - | - | - | € 917,00 € 751,40 | - |
| | | Ø890 | € 707,00 € 579,15 | € 707,00 € 579,15 | - | - | - | - |
| 890x890 | | € 707,00 € 579,15 | € 707,00 € 579,15 | - | - | - | - | |

Prices in bold are VAT included (VAT 22%)

I prezzi in grassetto si intendono IVA inclusa (IVA 22%)

Solid laminate top finishes

Finiture ripiano in stratificato

*Anti-fingerprint finish
Finitura anti-impronta



CFC_BI FNP_NE*

Steel top finishes

Finiture ripiano in lamiera



BI200E VE100E GI100E AZ100E RO200E NERO

Marble top finishes

Finiture ripiano in marmo



MBA MGC

Composite marble top finishes

Finiture ripiano in agglomerato di marmo



MFP MBR

Frame finishes

Finiture telaio



BI200E NERO LU OA TN

Frame finish

Finitura telaio



BI200E VE100E GI100E AZ100E RO200E NERO

Frame finish

Finitura telaio



BI200 NERO LU OA TN

Frame finish

Finitura telaio



BI200E SA100E

ELLIOT

Coffee tables / Tavolini



5473



5475 H500

TECHNICAL DETAILS / Dettagli tecnici

Item 5473

Item 5475 h500

Ø 690
Ø 700

500
Ø 660

Ø 700
Ø 890
890x890

500
Ø 680

| Item Articolo | Frame Telaio | Top Ripiano | Solid laminate top included Incluso ripiano in stratificato | | Steel top included Incluso ripiano in lamiera | | Marble top included Incluso ripiano in marmo | Composite marble top included Incluso ripiano in agglomerato di marmo |
|------------------|---|-----------------------------|--|-----------------------------|--|---|---|--|
| | | | Sizes Dimensioni | CFC_BI (mm 10) | FNP_NE (mm 10) | BI200E, VE100E, GI100E, AZ100E, RO200E (mm 12) | NERO (mm 12) | MBA MGC (mm 20) |
| 5473 C | POWDER COATED Verniciato | Ø690 | € 431,00 € 352,95 | € 407,00 € 333,45 | - | - | - | - |
| | | Ø700 | - | - | € 401,50 € 328,90 | € 377,50 € 309,40 | - | - |
| | POLISHED ALUMINIUM Alluminio lucidato | Ø690 | € 446,50 € 365,95 | € 446,50 € 365,95 | - | - | - | - |
| | ANTIQUÉ BRASS / TITANIUM Ottone anticato / Titanio | Ø690 | € 550,00 € 450,45 | € 550,00 € 450,45 | - | - | - | - |
| 5475 H500 C | POWDER COATED Verniciato | Ø700 | - | - | - | - | € 766,50 € 627,90 | € 680,50 € 557,70 |
| | | Ø890 | € 588,00 € 481,65 | € 556,00 € 455,65 | - | - | - | - |
| | | 890x890 | € 588,00 € 481,65 | € 556,00 € 455,65 | - | - | - | - |
| | POLISHED ALUMINIUM Alluminio lucidato | Ø700 | - | - | - | - | € 814,00 € 666,90 | - |
| | | Ø890 | € 603,50 € 494,65 | € 603,50 € 494,65 | - | - | - | - |
| | | 890x890 | € 603,50 € 494,65 | € 603,50 € 494,65 | - | - | - | - |
| | ANTIQUÉ BRASS / TITANIUM Ottone anticato / Titanio | Ø700 | - | - | - | - | € 925,00 € 757,90 | - |
| | | Ø890 | € 714,50 € 585,65 | € 714,50 € 585,65 | - | - | - | - |
| 890x890 | | € 714,50 € 585,65 | € 714,50 € 585,65 | - | - | - | - | |

Prices in bold are VAT included (VAT 22%)

I prezzi in grassetto si intendono IVA inclusa (IVA 22%)

Solid laminate top finishes

Finiture ripiano in stratificato

*Anti-fingerprint finish
Finitura anti-impronta



CFC_BI FNP_NE*

Steel top finishes

Finiture ripiano in lamiera



BI200E VE100E GI100E AZ100E RO200E NERO

Marble top finishes

Finiture ripiano in marmo



MBA MGC

Composite marble top finishes

Finiture ripiano in agglomerato di marmo



MFP MBR

Frame finishes

Finiture telaio



BI200E NERO LU OA TN

Frame finish

Finitura telaio

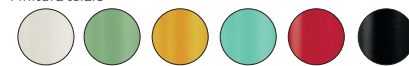

BI200E VE100E GI100E AZ100E RO200E NERO

Frame finish

Finitura telaio



BI200 NERO LU OA TN

Frame finish

Finitura telaio



BI200E SA100E

EXTESO

Extensible tables / Tavoli allungabili



| Item Articolo | Frame Telaio | | Top included Incluso ripiano | |
|------------------|---------------------------|--------------------|---------------------------------|--|
| | Sizes Dimensioni | Finish Finitura | BI - RS - W | VAT NOT INCLUDED Iva esclusa 22% |
| TE2_178X90 | 1780 → 2280 → 2780 (X900) | BI - RS - W | € 3.093,00 | € 2.535,00 |

TECHNICAL DETAILS / Dettagli tecnici

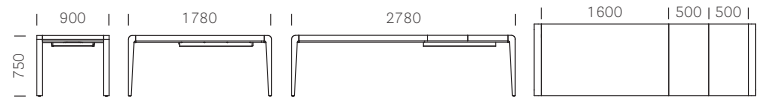

Finishes

Finiture



W
Wenge stained oak
Rovere tinto wengé



RS
Bleached oak
Rovere sbiancato



BI
White matt
lacquered
Laccato bianco
goffrato

FABBRICO



Fixed tables / Tavoli fissi



| Item Articolo | Sizes Dimensioni | Finish Finitura | Steel top included Incluso ripiano acciaio | | |
|------------------|---------------------|--------------------|---|-----------------|--|
| | | | TR | BIE | VAT NOT INCLUDED Iva esclusa 22% |
| TFA_70X70 | 700X700 | TR | € 382,50 | - | € 313,30 |
| | | BIE | - | € 347,50 | € 284,70 |
| TFA_80X80 | 800X800 | TR | € 398,50 | - | € 326,30 |
| | | BIE | - | € 362,00 | € 296,40 |
| TFA120X80 | 1200X800 | TR | € 471,50 | - | € 386,10 |
| | | BIE | - | € 428,50 | € 351,00 |
| TFA160X80 | 1600X800 | TR | € 549,00 | - | € 449,80 |
| | | BIE | - | € 498,50 | € 408,20 |

TECHNICAL DETAILS / Dettagli tecnici

Item TFA_70X70

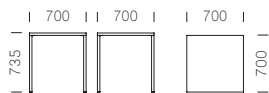

Stackable: 10 pcs

Item TFA_80X80

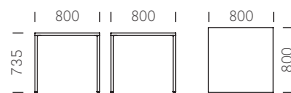

Stackable: 10 pcs

Item TFA120X80

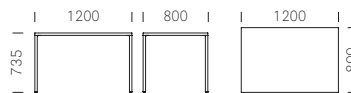

Item TFA160X80

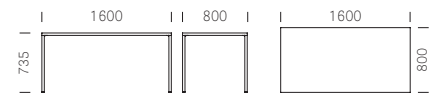

Finishes

Finiture



TR



BIE

FLUXO

Fixed tables / Tavoli fissi



5460



5465

| Item Articolo | Frame Telaio Finish Finitura | Top Ripiano Sizes Dimensioni | Solid laminate top included Incluso ripiano in stratificato | | Marble top included Incluso ripiano in marmo |
|------------------|--|---------------------------------------|--|-----------------------------|---|
| | | | CFC_BI (mm 10) | FNP_NE (mm 10) | MBA MGC (mm 20) |
| 5460 C | POWDER COATED Verniciato | Ø690 | € 396,00 € 324,35 | € 396,00 € 324,35 | - - |
| | POLISHED ALUMINIUM Alluminio lucidato | Ø690 | € 427,50 € 350,35 | € 427,50 € 350,35 | - - |
| | TITANIUM Titanio | Ø690 | € 551,50 € 451,75 | € 551,50 € 451,75 | - - |
| 5465 C | POWDER COATED Verniciato | Ø700 | - - | - - | € 750,50 € 614,90 |
| | | Ø790 | € 459,50 € 376,35 | € 459,50 € 376,35 | - - |
| | POLISHED ALUMINIUM Alluminio lucidato | Ø700 | - - | - - | € 793,00 € 650,00 |
| | | Ø790 | € 502,00 € 411,45 | € 502,00 € 411,45 | - - |
| | TITANIUM Titanio | Ø700 | - - | - - | € 929,50 € 761,80 |
| | | Ø790 | € 638,50 € 523,25 | € 638,50 € 523,25 | - - |

Prices in bold are VAT included (VAT 22%)
I prezzi in grassetto si intendono IVA inclusa (IVA 22%)

TECHNICAL DETAILS / Dettagli tecnici

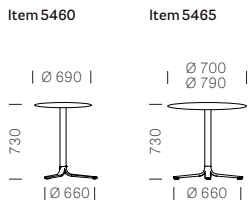

Solid laminate top finishes

Finiture ripiano in stratificato



Frame finishes

Finiture telaio



Marble top finish

Finitura ripiano in marmo

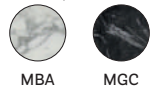

Frame finish

Finitura telaio

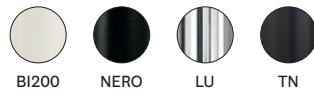

FLUXO

Coffee tables / Tavolini



5463

5465 H500

| Item Articolo | Frame Telaio | Top Ripiano | Solid laminate top included Incluso ripiano in stratificato | | Marble top included Incluso ripiano in marmo | |
|------------------|--|--|--|-----------------------------|---|--------|
| | | | CFC_BI (mm 10) | FNP_NE (mm 10) | MBA MGC (mm 20) | |
| 5463 C | POWDER COATED Verniciato | Ø690 | € 404,00 € 330,85 | € 404,00 € 330,85 | - - | |
| | | POLISHED ALUMINIUM Alluminio lucidato | Ø690 | € 435,50 € 356,85 | € 435,50 € 356,85 | - - |
| | | TITANIUM Titanio | Ø690 | € 559,50 € 458,25 | € 559,50 € 458,25 | - - |
| 5465 H500 C | POWDER COATED Verniciato | Ø700 | - - | - - | € 758,50 € 621,40 | |
| | | Ø790 | € 467,50 € 382,85 | € 467,50 € 382,85 | - - | |
| | POLISHED ALUMINIUM Alluminio lucidato | Ø700 | - - | - - | € 801,00 € 656,50 | |
| | | Ø790 | € 510,00 € 417,95 | € 510,00 € 417,95 | - - | |
| | TITANIUM Titanio | Ø700 | - - | - - | € 937,50 € 768,30 | |
| | | Ø790 | € 646,50 € 529,75 | € 646,50 € 529,75 | - - | |

Prices in bold are VAT included (VAT 22%)
I prezzi in grassetto si intendono IVA inclusa (IVA 22%)

TECHNICAL DETAILS / Dettagli tecnici

Item 5463 Item 5465 h500

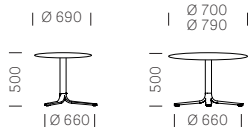

Solid laminate top finishes Finiture ripiano in stratificato

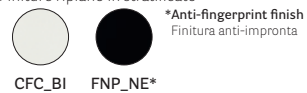

Frame finishes Finiture telaio

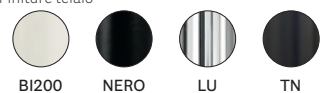

Marble top finish Finitura ripiano in marmo



Frame finish Finitura telaio



IKON

Fixed tables / Tavoli fissi



| Frame Telaio | | Top Ripiano | Solid laminate top included Incluso ripiano in stratificato | | | Steel top included Incluso ripiano in lamiera | Glass top included Incluso ripiano in vetro | |
|------------------|--------------------------------|---------------------|--|-----------------------------|-----------------------------|--|--|-----------------------------|
| Item Articolo | Finish Finitura | Sizes Dimensioni | CFC_BI (mm 10) | COL_NE (mm 12) | FPN_NE (mm 10) | BI100E (mm 12) | BIA (mm 10) | NER (mm 10) |
| 865 AD | POLYPROPYLENE Polipropilene | Ø690 | € 397,50 € 325,65 | - | € 397,50 € 325,65 | - | - | - |
| | | Ø700 | - | - | - | € 368,00 € 301,60 | - | - |
| | | 690x690 | - | € 305,50 € 250,25 | € 397,50 € 325,65 | - | - | - |
| | | 700x700 | - | - | - | € 368,00 € 301,60 | - | - |
| 866 AD | | Ø990 | € 726,50 € 595,40 | € 523,50 € 429,00 | € 726,50 € 595,40 | - | - | |
| 863 C | | Ø590 | € 306,50 € 250,90 | € 229,50 € 187,85 | € 306,50 € 250,90 | - | - | |
| 863V C | | Ø600 | - | - | - | - | € 314,50 € 257,40 | € 266,50 € 218,40 |

Prices in bold are VAT included (VAT 22%)
I prezzi in grassetto si intendono IVA inclusa (IVA 22%)

TECHNICAL DETAILS / Dettagli tecnici

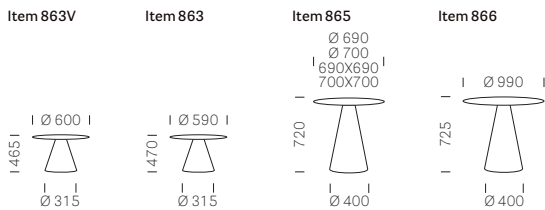

Solid laminate top finishes Finiture ripiano in stratificato



*Anti-fingerprint finish
Finitura anti-impronta

Steel top finish Finitura ripiano in lamiera



Glass top finishes Finiture ripiano in vetro



Polypropylene colours Colori polipropilene



Polypropylene colours Colori polipropilene



Polypropylene colours Colori polipropilene



IKON

Fixed tables / Tavoli fissi



| Frame Telaio | | Top Ripiano | Solid laminate top included Incluso ripiano in stratificato | | MDF top included Incluso ripiano in MDF | Laminate top included Incluso ripiano in laminato | |
|------------------|-----------------------------|---------------------|--|---------------------------------|--|--|---------------------------------|
| Item Articolo | Finish Finitura | Sizes Dimensioni | CFC_BI (mm 10) | FNP_NE (mm 10) | BI (mm 30) | BAI 30 (mm 30) white/bianco | BAN 30 (mm 30) black/nero |
| 869 C | POLYETHYLENE Polietilene | Ø1500 | - | - | € 1.404,00 | € 1.080,50 | |
| 869/2 C | | Ø1290 | € 1.343,50 € 1.101,10 | € 1.296,00 € 1.062,10 | - | - | |

Prices in bold are VAT included (VAT 22%)
I prezzi in grassetto si intendono IVA inclusa (IVA 22%)

TECHNICAL DETAILS / Dettagli tecnici

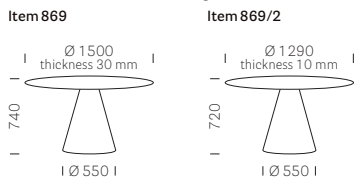

Solid laminate top finishes Finiture ripiano in stratificato



MDF top finish Finitura ripiano in MDF



Laminate top finishes Finiture ripiano in laminato

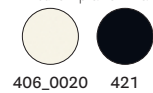

Polyethylene colours Colori polietilene



Polyethylene colours Colori polietilene



Polyethylene colours Colori polietilene

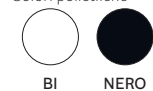



Solid laminate top finishes Finiture ripiano in stratificato



Laminate top finishes Finiture ripiano in laminato

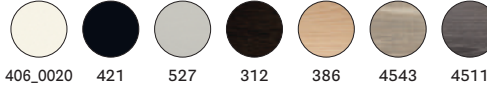
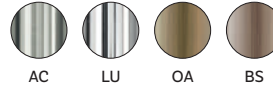

Table base finishes Finiture basamento



| Item Articolo | Frame Telaio Finish Finitura | Top Ripiano Sizes Dimensioni | Solid laminate top included Incluso ripiano in stratificato | | | Laminate top included Incluso ripiano in laminato | |
|------------------------|--|---------------------------------------|--|-----------------------------|---|--|-----------------------------|
| | | | CFC_BI (mm 10) | FNP_NE (mm 10) | COP 4529, 4512, 4519, 4543, 4573, 4575, 4511, 4517 (mm 10) | BA 20 (mm 20) | BA 50 (mm 50) |
| 4401/AC C | BRUSHED STAINLESS STEEL Acciaio inox satinato | Ø590 | € 328,00 € 268,45 | € 328,00 € 268,45 | € 256,50 € 209,95 | € 222,50 € 182,00 | € 224,00 € 183,30 |
| | | Ø690 | € 382,50 € 313,30 | € 382,50 € 313,30 | € 297,50 € 243,75 | € 249,50 € 204,10 | € 255,50 € 209,30 |
| 4401/LU C | POLISHED STAINLESS STEEL Acciaio inox lucidato | Ø590 | € 349,00 € 285,87 | € 349,00 € 285,87 | € 277,50 € 227,37 | € 243,50 € 199,42 | € 245,00 € 200,72 |
| | | Ø690 | € 403,50 € 330,72 | € 403,50 € 330,72 | € 319,00 € 261,17 | € 270,50 € 221,52 | € 277,00 € 226,72 |
| 4401/OA C 4401/BS C | ANTIQUÉ BRASS / BRONZE Ottone / bronzo anticato | Ø590 | € 432,50 € 354,25 | € 432,50 € 354,25 | € 361,00 € 295,75 | € 327,00 € 267,80 | € 328,50 € 269,10 |
| | | Ø690 | € 487,00 € 399,10 | € 487,00 € 399,10 | € 402,50 € 329,55 | € 354,00 € 289,90 | € 360,50 € 295,10 |
| 4411/AC C | BRUSHED STAINLESS STEEL Acciaio inox satinato | Ø590 | € 347,50 € 284,57 | € 347,50 € 284,57 | € 276,00 € 226,07 | € 242,00 € 198,12 | € 243,50 € 199,42 |
| | | Ø690 | € 402,00 € 329,42 | € 402,00 € 329,42 | € 317,50 € 259,87 | € 269,00 € 220,22 | € 275,50 € 225,42 |
| | | Ø790 | € 454,50 € 372,32 | € 454,50 € 372,32 | € 363,50 € 297,57 | € 295,00 € 241,67 | € 308,50 € 252,72 |
| | | Ø890 | € 535,50 € 438,62 | € 535,50 € 438,62 | € 433,00 € 354,77 | € 328,50 € 268,97 | € 349,00 € 285,87 |
| 4411/LU C | POLISHED STAINLESS STEEL Acciaio inox lucidato | Ø590 | € 380,00 € 311,35 | € 380,00 € 311,35 | € 308,50 € 252,85 | € 274,50 € 224,90 | € 276,00 € 226,20 |
| | | Ø690 | € 435,00 € 356,20 | € 435,00 € 356,20 | € 350,00 € 286,65 | € 301,50 € 247,00 | € 308,00 € 252,20 |
| | | Ø790 | € 487,00 € 399,10 | € 487,00 € 399,10 | € 396,00 € 324,35 | € 328,00 € 268,45 | € 341,00 € 279,50 |
| | | Ø890 | € 568,00 € 465,40 | € 568,00 € 465,40 | € 465,50 € 381,55 | € 361,00 € 295,75 | € 381,50 € 312,65 |

Prices in bold are VAT included (VAT 22%)
I prezzi in grassetto si intendono IVA inclusa (IVA 22%)

TECHNICAL DETAILS / Dettagli tecnici

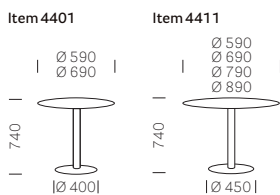

INOX

Fixed tables / Tavoli fissi



Solid laminate top finishes Finiture ripiano in stratificato

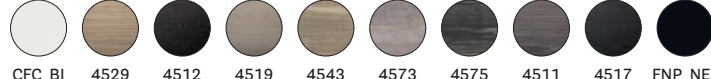

Laminate top finishes Finiture ripiano in laminato

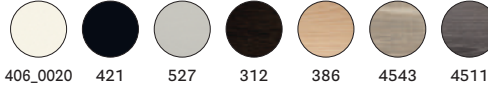
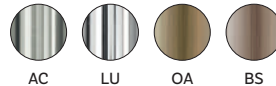
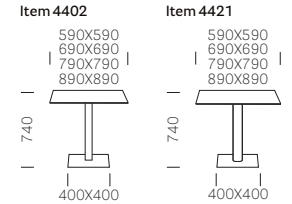

Table base finishes Finiture basamento



*Anti-fingerprint finish
Finitura anti-impronta

TECHNICAL DETAILS / Dettagli tecnici



| Item Articolo | Frame Telaio | Top Ripiano | Solid laminate top included Incluso ripiano in stratificato | | | Laminate top included Incluso ripiano in laminato | |
|------------------------|--|----------------|--|-----------------------------|-----------------------------|--|---|
| | | | Finish Finitura | Sizes Dimensioni | CFC_BI (mm 10) | FNP_NE (mm 10) | COP 4529, 4512, 4519, 4543, 4573, 4575, 4511, 4517 (mm 10) |
| 4402/AC C | BRUSHED STAINLESS STEEL Acciaio inox satinato | 590x590 | € 360,50 € 295,23 | € 360,50 € 295,23 | € 289,00 € 236,73 | € 230,50 € 188,63 | € 250,00 € 204,88 |
| | | 690x690 | € 415,00 € 340,08 | € 415,00 € 340,08 | € 330,50 € 270,53 | € 250,00 € 204,88 | € 279,00 € 228,28 |
| | | 790x790 | € 467,50 € 382,98 | € 467,50 € 382,98 | € 376,50 € 308,23 | € 271,50 € 222,43 | € 310,50 € 254,28 |
| | | 890x890 | € 548,50 € 449,28 | € 548,50 € 449,28 | € 446,00 € 365,43 | € 298,50 € 244,53 | € 338,00 € 277,03 |
| 4402/LU C | POLISHED STAINLESS STEEL Acciaio inox lucidato | 590x590 | € 386,50 € 316,68 | € 386,50 € 316,68 | € 315,00 € 258,18 | € 256,50 € 210,08 | € 276,50 € 226,33 |
| | | 690x690 | € 441,50 € 361,53 | € 441,50 € 361,53 | € 356,50 € 291,98 | € 276,50 € 226,33 | € 305,00 € 249,73 |
| | | 790x790 | € 493,50 € 404,43 | € 493,50 € 404,43 | € 402,50 € 329,68 | € 298,00 € 243,88 | € 336,50 € 275,73 |
| | | 890x890 | € 574,50 € 470,73 | € 574,50 € 470,73 | € 472,00 € 386,88 | € 324,50 € 265,98 | € 364,50 € 298,48 |
| 4402/OA C 4402/BS C | ANTIQUÉ BRASS / BRONZE Ottone / bronzo anticato | 590x590 | € 465,00 € 381,03 | € 465,00 € 381,03 | € 393,50 € 322,53 | € 335,00 € 274,43 | € 355,00 € 290,68 |
| | | 690x690 | € 520,00 € 425,88 | € 520,00 € 425,88 | € 435,00 € 356,33 | € 355,00 € 290,68 | € 383,50 € 314,08 |
| | | 790x790 | € 572,00 € 468,78 | € 572,00 € 468,78 | € 481,00 € 394,03 | € 376,50 € 308,23 | € 415,00 € 340,08 |
| | | 890x890 | € 653,00 € 535,08 | € 653,00 € 535,08 | € 551,00 € 451,23 | € 403,50 € 330,33 | € 443,00 € 362,83 |
| 4421/AC C | BRUSHED STAINLESS STEEL Acciaio inox satinato | 590x590 | € 354,00 € 289,90 | € 354,00 € 289,90 | € 282,50 € 231,40 | € 224,00 € 183,30 | € 243,50 € 199,55 |
| | | 690x690 | € 408,50 € 334,75 | € 408,50 € 334,75 | € 324,00 € 265,20 | € 243,50 € 199,55 | € 272,00 € 222,95 |
| | | 790x790 | € 461,00 € 377,65 | € 461,00 € 377,65 | € 370,00 € 302,90 | € 265,00 € 217,10 | € 304,00 € 248,95 |
| | | 890x890 | € 542,00 € 443,95 | € 542,00 € 443,95 | € 439,50 € 360,10 | € 292,00 € 239,20 | € 331,50 € 271,70 |
| 4421/LU C | POLISHED STAINLESS STEEL Acciaio inox lucidato | 590x590 | € 372,00 € 304,59 | € 372,00 € 304,59 | € 300,50 € 246,09 | € 242,00 € 197,99 | € 261,50 € 214,24 |
| | | 690x690 | € 426,50 € 349,44 | € 426,50 € 349,44 | € 341,50 € 279,89 | € 261,50 € 214,24 | € 290,00 € 237,64 |
| | | 790x790 | € 479,00 € 392,34 | € 479,00 € 392,34 | € 387,50 € 317,59 | € 283,00 € 231,79 | € 322,00 € 263,64 |
| | | 890x890 | € 560,00 € 458,64 | € 560,00 € 458,64 | € 457,50 € 374,79 | € 310,00 € 253,89 | € 349,50 € 286,39 |

Prices in bold are VAT included (VAT 22%)
I prezzi in grassetto si intendono IVA inclusa (IVA 22%)

INOX

Fixed tables / Tavoli fissi



4401



4411



4431

| Item Articolo | Frame Telaio | Top Ripiano | Glass top included Incluso ripiano in vetro | | |
|------------------|---|---------------------|--|-----------------------------|-----------------------------|
| | Finish Finitura | Sizes Dimensioni | BIA (mm 10) | NER (mm 10) | TRA (mm 12) |
| 4401/AC C | BRUSHED STAINLESS STEEL Acciaio inox satinato | Ø600 | € 483,00 € 395,85 | € 446,50 € 365,69 | - - |
| 4401/LU C | POLISHED STAINLESS STEEL Acciaio inox lucidato | Ø600 | € 504,50 € 413,27 | € 467,50 € 383,11 | - - |
| 4411/AC C | BRUSHED STAINLESS STEEL Acciaio inox satinato | Ø900 | € 642,50 € 526,37 | € 587,00 € 480,87 | - - |
| 4411/LU C | POLISHED STAINLESS STEEL Acciaio inox lucidato | Ø900 | € 675,00 € 553,15 | € 619,50 € 507,65 | - - |
| 4431/AC C | BRUSHED STAINLESS STEEL Acciaio inox satinato | Ø1300 | - - | - - | € 918,00 € 752,05 |
| 4431/LU C | POLISHED STAINLESS STEEL Acciaio inox lucidato | Ø1300 | - - | - - | € 955,50 € 782,86 |

Prices in bold are VAT included (VAT 22%)

I prezzi in grassetto si intendono IVA inclusa (IVA 22%)

TECHNICAL DETAILS / Dettagli tecnici

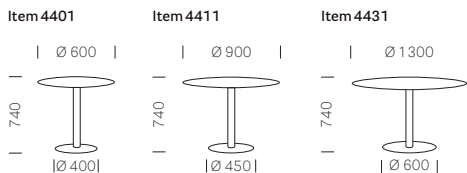

Glass top finishes Finiture ripiano in vetro

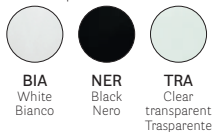
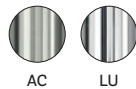

Table base finishes Finiture basamento



INOX

Coffee tables / Tavolini



4401 H400



4412 H400

| Frame Telaio | | Top Ripiano | Marble top included Incluso ripiano in marmo | | |
|---------------------------|-----------------------------------|---------------------|---|----------------|--|
| Item Articolo | Finish Finitura | Sizes Dimensioni | MBA, MGC (mm 20) | MED (mm 20) | VAT NOT INCLUDED Iva esclusa 22% |
| 4401/OA H400 REG4000 C | ANTIQUÉ BRASS Ottone anticato | Ø500 | € 708,50 | - | € 580,45 |
| 4401/BS H400 REG4000 C | ANTIQUÉ BRONZE Bronzo anticato | Ø500 | - | € 708,50 | |
| 4412/OA H500 REG4000 C | ANTIQUÉ BRASS Ottone anticato | Ø600 | € 728,00 | - | € 596,70 |
| 4412/BS H500 REG4000 C | ANTIQUÉ BRONZE Bronzo anticato | Ø600 | - | € 728,00 | |

TECHNICAL DETAILS / Dettagli tecnici

Item 4401 H400

Item 4412 H500

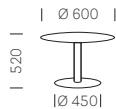
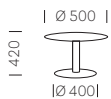

Marble top finishes Finiture ripiano in marmo



Table base finishes Finiture basamento



INOX

Fixed tables / Tavoli fissi



| Frame Telaio | | Top Ripiano | Solid laminate top included Incluso ripiano in stratificato | Laminate top included Incluso ripiano in laminato |
|------------------|--|---------------------|--|--|
| Item Articolo | Finish Finitura | Sizes Dimensioni | CFC_BI (mm 10) | BA/30FN (mm 30) |
| 4471/AC REG C | BRUSHED STAINLESS STEEL Acciaio inox satinato | 1090X790 | € 797,50 € 653,51 | € 495,50 € 405,86 |
| | | 1190X790 | € 797,50 € 653,51 | € 495,50 € 405,86 |
| | | 1390X790 | - | € 547,50 € 448,76 |
| 4461/AC REG C | BRUSHED STAINLESS STEEL Acciaio inox satinato | 1590X790 | - | € 616,50 € 505,18 |

Prices in bold are VAT included (VAT 22%)

I prezzi in grassetto si intendono IVA inclusa (IVA 22%)

TECHNICAL DETAILS / Dettagli tecnici

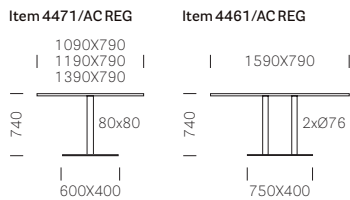

Solid laminate top finish
Finitura ripiano in stratificato



CFC_BI

Laminate top finishes
Finiture ripiano in laminato



0720*



0718*

*Anti-fingerprint finish
Finitura anti-impronta

Table base finish
Finitura basamento



AC

INOX ellittico

Fixed tables / Tavoli fissi



| Frame Telaio | | Top Ripiano | Solid laminate top included Incluso ripiano in stratificato | |
|------------------|--|---------------------|--|--|
| Item Articolo | Finish Finitura | Sizes Dimensioni | CFC_BI (mm 10) | VAT NOT INCLUDED Iva esclusa 22% |
| 4901/AC C | BRUSHED STAINLESS STEEL Acciaio inox satinato | E 1600X950 | € 1.529,50 | € 1.253,59 |
| 4901/AC C | | E 1800X1100 | € 2.014,00 | € 1.650,74 |
| 4903/AC C | | E 1200X800 | € 806,50 | € 660,92 |

TECHNICAL DETAILS / Dettagli tecnici

Item 4901

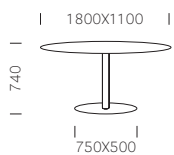

Item 4901

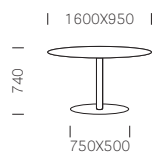

Item 4903

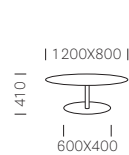

Solid laminate top finish
Finitura ripiano in stratificato



Table base finish
Finitura basamento



JUMP

Fixed tables / Tavoli fissi



| Frame only Solo telaio | | Top included Incluso ripiano | Solid laminate top included Incluso ripiano in stratificato | | | |
|---------------------------|--------------------|---------------------------------|--|--|--|--|
| Item Articolo | Finish Finitura | Item Articolo | COM black nero, (mm 12) | VAT NOT INCLUDED Iva esclusa 22% | CFC_BI (mm 10)  | VAT NOT INCLUDED Iva esclusa 22% |
| TJ4 | NERO | _79X79 COM | € 473,00 | € 387,40 | | |
| | BI | _79X79 CFC | | | € 580,00 | € 475,15 |
| | NERO | 119X79 COM | € 580,00 | € 475,15 | | |
| | BI | 119X79 CFC | | | € 725,00 | € 594,10 |

TECHNICAL DETAILS / Dettagli tecnici

Item TJ4_79X79

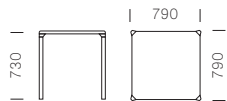

Item TJ4_119X79

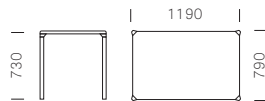

Solid laminate top finishes Finiture ripiano in stratificato



Frame finishes Finiture telaio

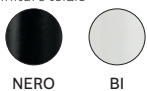

KRYSTAL

Fixed tables / Tavoli fissi



| Frame Telaio | | Top Ripiano | Solid laminate top included Incluso ripiano in stratificato | |
|------------------|---|---------------------|--|--|
| Item Articolo | Finish Finitura | Sizes Dimensioni | CFC_BI (mm 10) | VAT NOT INCLUDED Iva esclusa 22% |
| 4431/KRREG_AC C | BRUSHED STAINLESS STEEL Acciaio inox satinato | Ø1290 | € 1.228,50 | € 1.006,85 |
| 4431/KRREG_LU C | POLISHED STAINLESS STEEL Acciaio inox lucidato | Ø1290 | € 1.241,00 | € 1.016,86 |

TECHNICAL DETAILS / Dettagli tecnici

Item 4431/KRREG

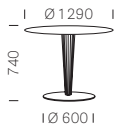

Solid laminate top finish
Finitura ripiano in stratificato



CFC_BI

Methacrylate column finish
Finitura colonna in metacrilato



TR
Clear transparent
Trasparente

Table base finishes
Finiture basamento



AC



LU

KUADRO

Fixed tables / Tavoli fissi



| Item Articolo | Frame only Solo telaio | | Item Articolo | Glass top included Incluso ripiano in vetro | |
|------------------|---------------------------|--------------------|------------------|--|--|
| | Sizes Dimensioni | Finish Finitura | | SAT (mm 12) | VAT NOT INCLUDED Iva esclusa 22% |
| TK_80X80 | 800X800 | ST | _80X80 SAT TK | € 674,50 | € 552,50 |
| TK_90X90 | 900X900 | ST | _90X90 SAT TK | € 754,50 | € 618,41 |
| TK_120X120 | 1200X1200 | ST | 120X120 SAT TK | € 1.066,00 | € 873,60 |
| TK_120X69 | 1200X690 | ST | 120X69 SAT TK | € 773,50 | € 633,88 |
| TK_140X80 | 1400X800 | ST | 140X80 SAT TK | € 878,50 | € 719,81 |
| TK_180X90 | 1800X900 | ST | 180X90 SAT TK | € 1.113,50 | € 912,60 |

TECHNICAL DETAILS / Dettagli tecnici

Item TK_80X80

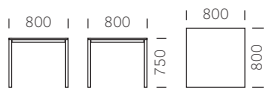

Item TK_90X90

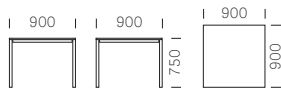

Item TK_120X120

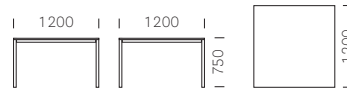

Item TK_120X69

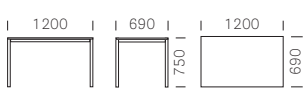

Item TK_140X80

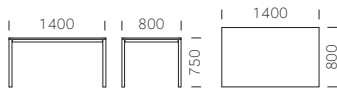

Item TK_180X90

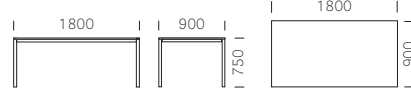

Glass top finish
Finitura ripiano in vetro



SAT
Frosted
Acidato

Frame finish
Finitura telaio



ST

KUADRO

Fixed tables / Tavoli fissi



| Item Articolo | Frame Telaio | | Top Ripiano | Laminated top included Incluso ripiano in laminato | |
|------------------|---------------------|--------------------|----------------|---|--|
| | Sizes Dimensioni | Finish Finitura | | BA/20FN 0720, 0718 (mm 20) | VAT NOT INCLUDED Iva esclusa 22% |
| TK2_79X79 | 790X790 | NERO | _79X79 | € 328,50 | € 269,10 |
| | | ST | | € 452,50 | € 370,50 |
| TK2_89X89 | 890X890 | NERO | _89X89 | € 373,00 | € 305,50 |
| | | ST | | € 503,00 | € 412,10 |
| TK2_119X119 | 1190X1190 | NERO | 119X119 | € 593,50 | € 486,20 |
| | | ST | | € 771,00 | € 631,80 |
| TK2_119X69 | 1190X690 | NERO | 119X69 | € 406,50 | € 332,80 |
| | | ST | | € 539,50 | € 442,00 |
| TK2_139X79 | 1390X790 | NERO | 139X79 | € 484,00 | € 396,50 |
| | | ST | | € 630,00 | € 516,10 |
| TK2_179X89 | 1790X890 | NERO | 179X89 | € 641,00 | € 525,20 |
| | | ST | | € 826,50 | € 677,30 |

TECHNICAL DETAILS / Dettagli tecnici

Item TK2_79X79

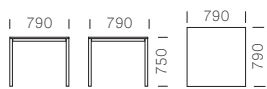

Item TK2_89X89

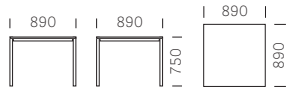

Item TK2_119X119

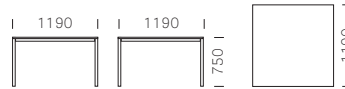

Item TK2_119X69

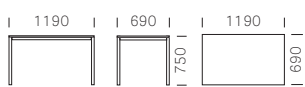

Item TK2_139X79

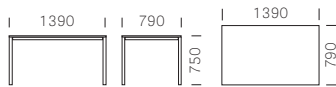

Item TK2_179X89

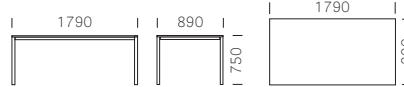

Laminate top finishes

Finiture ripiano in laminato



0720* 0718*

*Anti-fingerprint finish
Finitura anti-impronta

Frame finishes

Finiture telaio



NERO ST

KUADRO desk

Fixed tables / Tavoli fissi



| Frame Telaio | | | Laminated top included Incluso ripiano in laminato | | |
|--|---------------------|-----------------------------|---|--------------------------------------|--|
| Item Articolo | Sizes Dimensioni | Finish Finitura | ABET 406_0020, 527 (mm 20) | Fittings Accessori | VAT NOT INCLUDED Iva esclusa 22% |
| TK2S179X140 | 1790X1400 | POWDER COATED Verniciato | € 856,50 | - | € 702,00 |
| DSP Panel only (1 pc) Solo pannello (1 pz) | 1500X440h | G H60+H64 | - | € 560,00 € 393,50 | € 458,90 € 322,40 |
| TK2S340X140 | 3400X1400 | POWDER COATED Verniciato | € 1.634,00 | - | € 1.339,00 |
| DSP Panel only (2pcs) Solo pannello (2pz) | 1500X440h | G H60+H64 | - | € 1.120,00 € 787,00 | € 917,80 € 644,80 |

TECHNICAL DETAILS / Dettagli tecnici

Item TK2S179X140

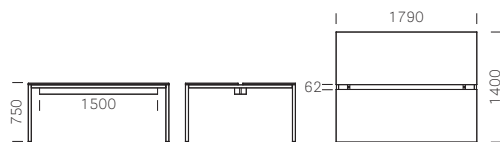

Item TK2S340X140

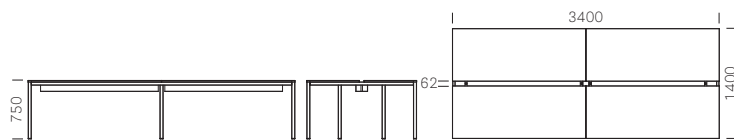

Laminate top finishes Finiture ripiano in laminato

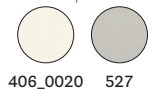

Frame finishes Finiture telaio



For fabrics see page 306
Per i tessuti si veda a p. 306

Accessori - Fittings

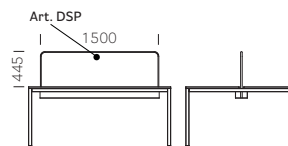

Accessori - Fittings

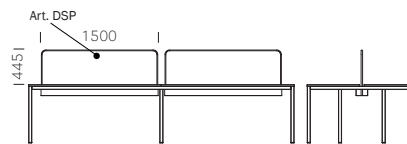

LAJA

Fixed tables / Tavoli fissi



| Frame Telaio | | Top Ripiano | Solid laminate top included Incluso ripiano in stratificato | | | Steel top included Incluso ripiano in lamiera | |
|------------------|-----------------------------|---------------------|--|-----------------------------|-----------------------------|--|-----------------------------|
| Item Articolo | Finish Finitura | Sizes Dimensioni | CFC_BI (mm 10) | COI_NE (mm 12) | FNP_NE (mm 10) | BI200E (mm 12) | NERO (mm 12) |
| 5420 C | POWDER COATED Verniciato | Ø790 | € 499,00 € 408,85 | € 366,50 € 300,30 | € 467,50 € 382,85 | - | - |
| | | 690x690 | € 446,50 € 365,95 | € 329,50 € 269,75 | € 415,00 € 339,95 | - | - |
| | | 700x700 | - | - | - | € 411,00 € 336,70 | € 385,50 € 315,90 |
| 5430 C | POWDER COATED Verniciato | Ø990 | € 745,50 € 611,00 | € 504,50 € 413,40 | € 701,50 € 574,60 | - | - |
| | | 890x890 | € 624,50 € 511,55 | € 467,50 € 382,85 | € 580,00 € 475,15 | - | - |

Prices in bold are VAT included (VAT 22%)
I prezzi in grassetto si intendono IVA inclusa (IVA 22%)

TECHNICAL DETAILS / Dettagli tecnici

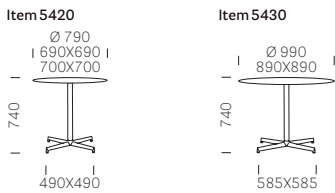

Solid laminate top finishes
Finiture ripiano in stratificato



*Anti-fingerprint finish
Finitura anti-impronta

Steel top finishes
Finiture ripiano in lamiera



Frame finishes
Finiture telaio

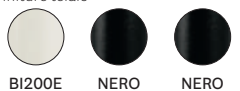

Frame finishes
Finiture telaio





| Frame Telaio | | Top Ripiano | Solid laminate top included Incluso ripiano in stratificato | | | Steel top included Incluso ripiano in lamiera | |
|------------------|-----------------------------|---------------------|--|-----------------------------|-----------------------------|--|-----------------------------|
| Item Articolo | Finish Finitura | Sizes Dimensioni | CFC_BI (mm 10) | COI_NE (mm 12) | FNP_NE (mm 10) | BI200E (mm 12) | NERO (mm 12) |
| 5420 H400 C | POWDER COATED Verniciato | Ø790 | € 500,50 € 410,15 | € 368,00 € 301,60 | € 475,50 € 389,35 | - | - |
| | | 690x690 | € 448,50 € 367,25 | € 331,00 € 271,05 | € 423,00 € 346,45 | - | - |
| | | 700x700 | - | - | - | € 419,00 € 343,20 | € 393,50 € 322,40 |
| 5430 H400 C | POWDER COATED Verniciato | Ø990 | € 753,50 € 617,50 | € 512,50 € 419,90 | € 709,00 € 581,10 | - | - |
| | | 890x890 | € 632,50 € 518,05 | € 475,50 € 389,35 | € 588,00 € 481,65 | - | - |

Prices in bold are VAT included (VAT 22%)
I prezzi in grassetto si intendono IVA inclusa (IVA 22%)

TECHNICAL DETAILS / Dettagli tecnici

Item 5420H400



Item 5430H400



Solid laminate top finishes Finiture ripiano in stratificato



*Anti-fingerprint finish
Finitura anti-impronta

Steel top finish Finitura ripiano in lamiera



Frame finishes Finiture telaio

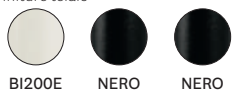

Frame finish Finitura telaio

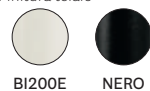



| Frame Telaio | | Top Ripiano | Solid laminate top included Incluso ripiano in stratificato | | | |
|----------------------------|-----------------------------|---------------------|--|--|-------------------|--|
| Item Articolo | Finish Finitura | Sizes Dimensioni | CFC_BI (mm 10)  | VAT NOT INCLUDED Iva esclusa 22% | FNP_NE (mm 10) | VAT NOT INCLUDED Iva esclusa 22% |
| 5420 H400 C 70X57 LOG C | POWDER COATED Verniciato | 700X570 | € 530,00 | € 434,20 | € 504,50 | € 413,40 |

TECHNICAL DETAILS / Dettagli tecnici

Item 5420 H400



Solid laminate top finishes

Finiture ripiano in stratificato

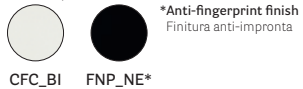

*Anti-fingerprint finish
Finitura anti-impronta

Table base finishes

Finiture basamento



LOGICO

Fixed tables / Tavoli fissi



| Frame Telaio | | | Frosted glass top included Incluso ripiano in vetro acidato | | |
|------------------|---------------------|--------------------|--|-------------------|--|
| Item Articolo | Sizes Dimensioni | Finish Finitura | Item Articolo | SAT (mm 12) | VAT NOT INCLUDED Iva esclusa 22% |
| TL_80X80 | 800X800 | AC | _80X80 SAT TL | € 1.052,00 | € 861,90 |
| TL_90X90 | 900X900 | | _90X90 SAT TL | € 1.140,50 | € 934,70 |
| TL_140X80 | 1400X800 | | 140X80 SAT TL | € 1.275,50 | € 1.045,20 |
| TL_180X90 | 1800X900 | | 180X90 SAT TL | € 1.367,50 | € 1.120,60 |

TECHNICAL DETAILS / Dettagli tecnici

Item TL_80X80

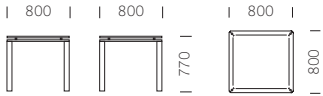

Item TL_140X80

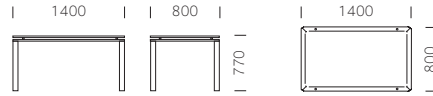

Item TL_90X90

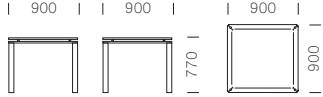

Item TL_180X90

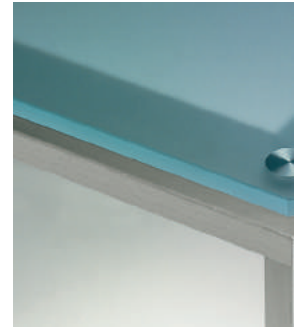
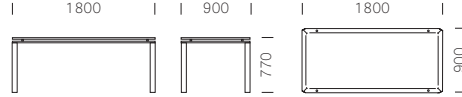

| Frame Telaio | | | Solid laminate top included Incluso ripiano in stratificato | | | |
|------------------|---------------------|--------------------|--|-------------------|-------------------|--|
| Item Articolo | Sizes Dimensioni | Finish Finitura | Item Articolo | CFC_BI (mm 6) | COM_NE (mm 8) | VAT NOT INCLUDED Iva esclusa 22% |
| TL_79X79 | 790X790 | BI | _79X79 CFC | € 820,00 | - | € 672,10 |
| | | NERO | _79X79 COM | - | € 820,00 | |
| TL_89X89 | 890X890 | BI | _89X89 CFC | € 990,00 | - | € 811,20 |
| | | NERO | _89X89 COM | - | € 990,00 | |
| TL_139X79 | 1390X790 | BI | 139X79 CFC | € 1.029,50 | - | € 843,70 |
| | | NERO | 139X79 COM | - | € 1.029,50 | |
| TL_179X89 | 1790X890 | BI | 179X89 CFC | € 1.565,50 | - | € 1.283,10 |
| | | NERO | 179X89 COM | - | € 1.565,50 | |

TECHNICAL DETAILS / Dettagli tecnici

Item TL_79X79

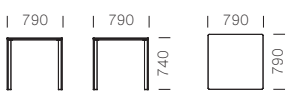

Item TL_139X79

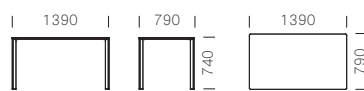

Item TL_89X89

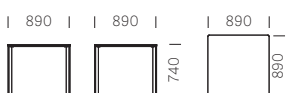

Item TL_179X89

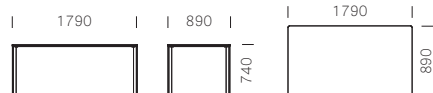

Glass top finish Finitura ripiano in vetro



Solid laminate top finishes Finiture ripiano in stratificato



Frame finishes Finiture telaio

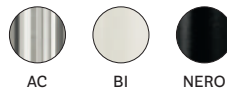

LUNAR

Fixed tables / Tavoli fissi



| Frame Telaio | | Top Ripiano | Solid laminate top included Incluso ripiano in stratificato | | Steel top included Incluso ripiano in lamiera | | Marble top included Incluso ripiano in marmo |
|------------------|-----------------------------|---------------------|--|----------------------|--|-----------------|---|
| Item Articolo | Finish Finitura | Sizes Dimensioni | CFC_BI (mm 10) | FNP_NE (mm 10) | BI200 (mm 12) | NERO (mm 12) | MBA MGC (mm 20) |
| 5440 C | POWDER COATED Verniciato | Ø600 | - | - | - | - | € 650,50 € 533,00 |
| | | Ø690 | € 431,00 € 352,95 | € 431,00 € 352,95 | - | - | - |
| | | 590x590 | € 376,00 € 308,10 | € 376,00 € 308,10 | - | - | - |
| | | 700x700 | - | - | € 401,50 € 328,90 | - | - |
| 5443 C | POWDER COATED Verniciato | Ø500 | - | - | - | - | € 642,50 € 526,50 |
| | | Ø690 | € 423,00 € 346,45 | € 423,00 € 346,45 | - | - | - |
| | | 590x590 | € 368,00 € 301,60 | € 368,00 € 301,60 | - | - | - |
| | | 700x700 | - | - | € 393,50 € 322,40 | - | - |

Prices in bold are VAT included (VAT 22%)
I prezzi in grassetto si intendono IVA inclusa (IVA 22%)

TECHNICAL DETAILS / Dettagli tecnici

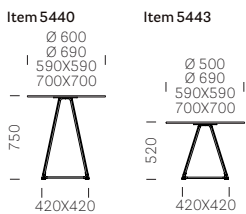

Solid laminate top finishes Finiture ripiano in stratificato



Marble top finishes Finiture ripiano in marmo

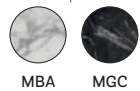

Steel top finishes Finiture ripiano in lamiera

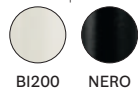

Table base finishes Finiture basamento

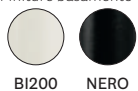
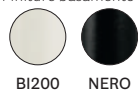

Table base finishes Finiture basamento



Table base finishes Finiture basamento



MAGIC

Extensible tables / Tavoli allungabili



| Frame Telaio | | | Glass top included Incluso ripiano in vetro | | | |
|------------------|---------------------|--------------------|--|----------------|----------------|--|
| Item Articolo | Sizes Dimensioni | Finish Finitura | Item Articolo | TRA (mm 12) | SAT (mm 12) | VAT NOT INCLUDED Iva esclusa 22% |
| TM_160X90 | 1600X900 → 2400X900 | AC | 160X90 TRA TS | € 2.189,00 | - | € 1.794,00 |
| TM_200X90 | 2000X900 → 2800X900 | | 200X90 TRA TS | € 2.347,50 | - | € 1.924,00 |
| | | | 200X90 SAT TS | - | € 2.442,50 | € 2.002,00 |

TECHNICAL DETAILS / Dettagli tecnici

Item TM_160X90

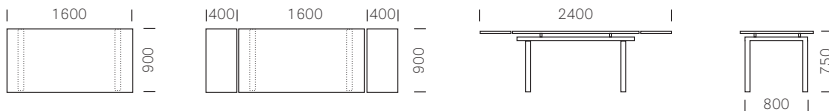

Item TM_200X90

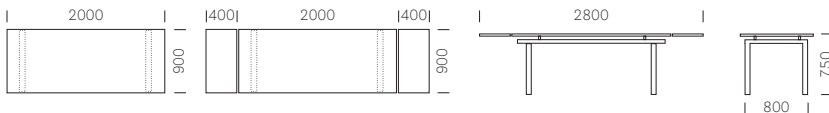

Glass top finishes Finiture ripiano in vetro

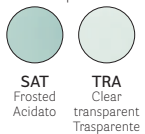

Frame finish Finitura telaio



MALMÖ

Fixed and extensible tables / Tavoli fissi e allungabili



| Frame Telaio | | | Solid laminate top included Incluso ripiano in stratificato | | | |
|------------------|---------------------|--------------------|--|-------------------|---------------------|--|
| Item Articolo | Sizes Dimensioni | Finish Finitura | Item Articolo | CFP_BI (mm 12) | COP_NERO (mm 12) | VAT NOT INCLUDED Iva esclusa 22% |
| TMLF_90X90 | 900X900 | FR | 90X90 | € 1.174,50 | - | € 962,65 |
| | | AN | | - | € 1.055,50 | € 865,15 |
| TMLF_140X90 | 1400X900 | FR | 140X90 | € 1.507,00 | - | € 1.235,00 |
| | | AN | | - | € 1.229,50 | € 1.007,50 |
| TMLF_180X90 | 1800X900 | FR | 180X90 | € 2.043,00 | - | € 1.674,40 |
| | | AN | | - | € 1.592,50 | € 1.305,20 |

TECHNICAL DETAILS / Dettagli tecnici

Item TMLF_90X90



Item TMLF_140X90

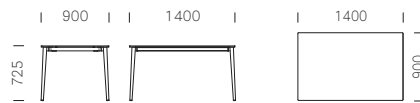

Item TMLF_180X90

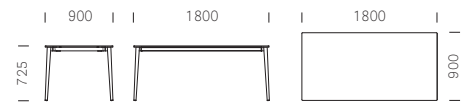

| Item Articolo | Frame Telaio Sizes Dimensioni | Finish Finitura | Veneered top included Incluso ripiano in impiallacciato | | | Solid laminate top included Incluso ripiano in stratificato | |
|------------------|--|--------------------|--|---------------|--|--|--|
| | | | FR (mm 14) | AN (mm 14) | VAT NOT INCLUDED Iva esclusa 22% | CFP_BI (mm 12) | VAT NOT INCLUDED Iva esclusa 22% |
| TML_190X90 | 1900X900 → 2900X900 | FR | € 2.815,50 | - | € 2.307,50 | € 2.769,50 | € 2.269,80 |
| | | AN | - | € 2.815,50 | | - | |

TECHNICAL DETAILS / Dettagli tecnici

Item TML_190X90

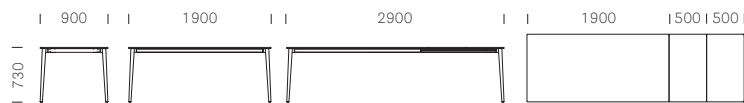

Solid laminate top finishes
Finiture ripiano in stratificato



Veneered top finishes
Finiture ripiano in impiallacciato



Ash frame
Telaio in frassino



MALMÖ

Coffee tables / Tavolini



| Item Articolo | Frame Telaio Sizes Dimensioni | Finish Finitura | Veneered top included Incluso ripiano in impiallacciato | Solid laminate top included Incluso ripiano in stratificato | | | MDF lacquered top included Incluso ripiano in MDF laccato |
|------------------------------|--|--------------------|--|--|-----------------------------|-----------------------------|--|
| | | | FR/AN (mm 22) | CFP_BI (mm 12) | COP_NE (mm 12) | FPN_NE (mm 10) | RAL3018/RAL1019 (mm 22) |
| MLTD_60X36 MLTD_60X48 | Ø 600X360h Ø 600X480h | FR/AN | € 618,00 € 506,35 | - | - | - | € 541,00 € 443,30 |
| | | FR | - | € 408,00 € 334,10 | - | - | - |
| | | AN | - | - | € 331,00 € 271,05 | € 487,00 € 399,10 | - |
| MLT_50X50X36 MLT_50X50X48 | 500X500X360h 500X500X480h | FR/AN | € 621,00 € 508,95 | - | - | - | € 549,00 € 449,80 |
| | | FR | - | € 490,50 € 401,70 | - | - | - |
| | | AN | - | - | € 405,50 € 332,15 | € 557,00 € 456,30 | - |
| MLT_60X60X36 MLT_60X60X48 | 600X600X360h 600X600X480h | FR/AN | € 684,50 € 560,95 | - | - | - | € 604,50 € 495,30 |
| | | FR | - | € 490,50 € 401,70 | - | - | - |
| | | AN | - | - | € 405,50 € 332,15 | € 557,00 € 456,30 | - |
| MLTD100X36 | Ø 1000X360h | FR/AN | € 1.078,00 € 883,35 | - | - | - | € 868,00 € 711,10 |
| | | FR | - | € 868,00 € 711,10 | - | - | - |
| MLT120X74X36 | 1200X740X360h | FR/AN | € 1.029,50 € 843,70 | - | - | - | - |
| | | AN | - | - | - | € 785,50 € 643,50 | - |

Prices in bold are vat included (IVA 22%)
I prezzi in grassetto si intendono iva inclusa (22%)

TECHNICAL DETAILS / Dettagli tecnici

Item MLTD100X36*

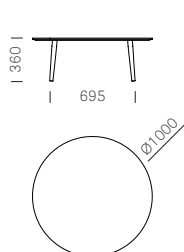

Item MLTD_60X36*

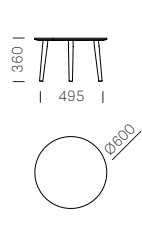

Item MLTD_60X48*

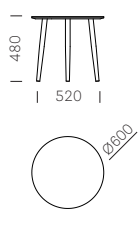

Item MLT_60X60X36*

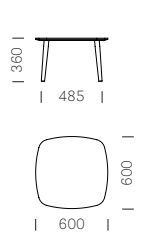

Item MLT_60X60X48*

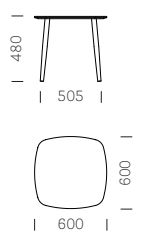

Item MLT120X74X36*

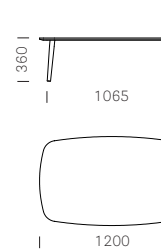

Item MLT_50X50X36*

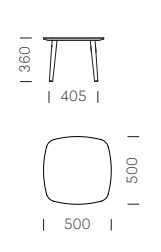

Item MLT_50X50X48*

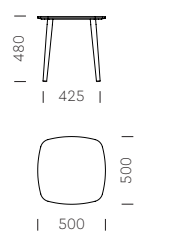

* Table height decreases of 1 cm for solid laminate top versions / L'altezza del tavolo si riduce di 1 cm per le versioni con ripiano in stratificato

MDF lacquered top finishes

Finiture ripiano MDF



RAL3018 RAL1019

Solid laminate top finishes

Finiture ripiano in stratificato



CFP_BI COP_NE FNP_NE*

*Anti-fingerprint finish
Finitura anti-impronta

Veneered top finishes

Finiture ripiano in impiallacciato



FR AN

Frame finishes

Finiture telaio



FR AN

MALMÖ marble

Coffee tables / Tavolini



| Item Articolo | Sizes Dimensioni | Finish Finitura | Marble top included Incluso ripiano in marmo | | VAT NOT INCLUDED Iva esclusa 22% |
|------------------|---------------------|--------------------|---|----------------|--|
| | | | MBA (mm 20) | MGC (mm 20) | |
| MLTD_60X36 | Ø 600X360h | FR | € 904,50 | - | € 741,00 |
| | | AN | - | € 904,50 | |
| MLTD_60X48 | Ø 600X480h | FR | € 904,50 | - | € 741,00 |
| | | AN | - | € 904,50 | |
| MLTD_70X36 | Ø 700X360h | FR | € 1.094,50 | - | € 897,00 |
| | | AN | - | € 1.094,50 | |
| MLTD_70X48 | Ø 700X480h | FR | € 1.094,50 | - | € 897,00 |
| | | AN | - | € 1.094,50 | |
| MLT_50X50X36 | 500X500X360h | FR | € 939,00 | - | € 769,60 |
| | | AN | - | € 939,00 | |
| MLT_50X50X48 | 500X500X480h | FR | € 939,00 | - | € 769,60 |
| | | AN | - | € 939,00 | |
| MLT_60X60X36 | 600X600X360h | FR | € 971,00 | - | € 795,60 |
| | | AN | - | € 971,00 | |
| MLT_60X60X48 | 600X600X480h | FR | € 971,00 | - | € 795,60 |
| | | AN | - | € 971,00 | |

TECHNICAL DETAILS / Dettagli tecnici

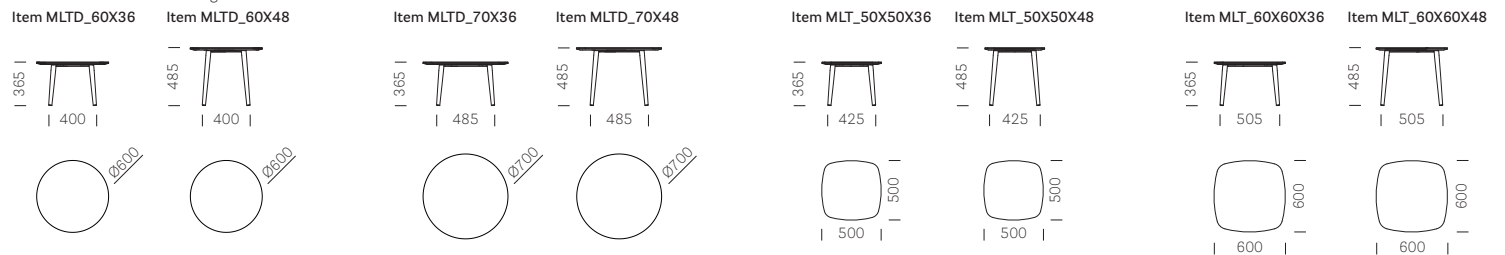

Marble top finishes Finiture ripiano in marmo

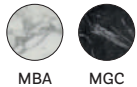

Frame finishes Finiture telaio



MATRIX

Extensible tables / Tavoli allungabili



| Item Articolo | Frame Telaio | Sizes Dimensioni | Finish Finitura | Glass top included Incluso ripiano in vetro | | Laminated top included Incluso ripiano in laminato |
|------------------|-----------------|---------------------|--------------------|--|-------------------|---|
| | | | | NER (mm 12) | BIA (mm 12) | ABET 312, 406_0020 (mm 20) |
| TMA_88X86 | | 880X860 → 1380X860 | AA | - | - | € 1.554,50 |
| | | | BI | - | - | € 1.274,00 |
| TMA_130X86 | | 1300X860 → 2100X860 | AA | € 2.146,00 | € 2.273,00 | € 1.848,00 |
| | | | NERO | € 1.758,90 | € 1.862,90 | € 1.514,50 |
| | | | BI | € 2.222,00 | - | - |
| TMA_165X86 | | 1650X860 → 2650X860 | AA | - | € 2.349,00 | € 1.924,00 |
| | | | NERO | € 1.821,30 | € 1.925,30 | € 1.576,90 |
| | | | BI | - | - | - |
| TMA_165X86 | | 1650X860 → 2650X860 | AA | € 2.368,00 | € 2.526,50 | € 2.006,50 |
| | | | NERO | € 1.940,90 | € 2.070,90 | € 1.644,50 |
| | | | BI | € 2.444,50 | - | - |
| | | | | - | € 2.603,00 | € 2.082,50 |
| | | | | - | € 2.133,30 | € 1.706,90 |

Prices in bold are VAT included (VAT 22%)
I prezzi in grassetto si intendono IVA inclusa (IVA 22%)

TECHNICAL DETAILS / Dettagli tecnici

Item TMA_88X86



Item TMA_130X86



Item TMA_165X86



Folding extension finish: laminate (for laminate top) or silver lacquered MDF (for glass top)
Finitura allunga: laminato (per ripiano in laminato) o MDF laccato argento (per ripiano in vetro)

Glass top finishes
Finiture ripiano in vetro

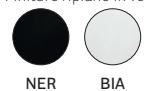

Laminate top finishes
Finiture ripiano in laminato



Frame finishes
Finiture telaio

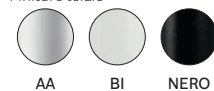

MATRIX console

Extensible tables / Tavoli allungabili



| Item Articolo | Sizes Dimensioni | Finish Finitura | Glass top included Incluso ripiano in vetro | |
|------------------|---------------------|--------------------|--|--|
| | | | NER (mm 12) | VAT NOT INCLUDED Iva esclusa 22% |
| TMC_160X50 | 1600X500 → 1600X875 | NERO | € 2.157,00 | € 1.768,00 |

TECHNICAL DETAILS / Dettagli tecnici

Item TMC_160X50

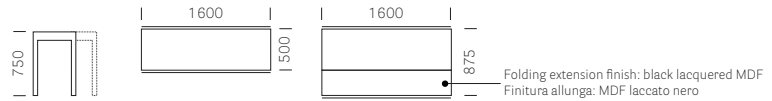

Glass top finish
Finitura ripiano in vetro



NER

Frame finish
Finitura telaio



NERO

MATRIX outdoor



Fixed tables / Tavoli fissi



| Item Articolo | Sizes Dimensioni | Finish Finitura | Solid laminate top included Incluso ripiano in stratificato | |
|------------------|---------------------|--------------------|--|--|
| | | | CFC_BI (mm 10) | VAT NOT INCLUDED Iva esclusa 22% |
| TMD_200X86 | 2000X860 | AA | € 2.125,50 | € 1.742,00 |

TECHNICAL DETAILS / Dettagli tecnici

Item TMD_200X86

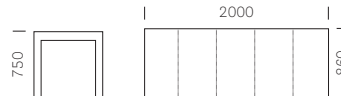

Solid laminate top finish
Finitura ripiano in stratificato



CFC_BI

Frame finish
Finitura telaio



AA

MATRIX Desk

Fixed tables / Tavoli fissi



| Item Articolo | Frame Telaio | | Laminated top included Incluso ripiano in laminato | | |
|--|---------------------|--------------------|---|-----------------------|--|
| | Sizes Dimensioni | Finish Finitura | ABET 312, 406_0020, 527 (mm 20) | Fittings Accessori | VAT NOT INCLUDED Iva esclusa 22% |
| TMS_200X160 | 2000X1600 | AA | € 1.887,50 | - | € 1.547,00 |
| TMS_350X160 | 3500X1600 | | € 2.617,00 | - | € 2.145,00 |
| CC/DSP Cable management only (1 pc) Solo canalina (1 pz) | 1500X150X120h | BIANCO | - | € 157,50 | € 128,70 |
| DSP Panel only (1 pc) Solo pannello (1 pz) | 1500X440h | G H60+H64 | - | € 560,00 € 393,50 | € 458,90 € 322,40 |

TECHNICAL DETAILS / Dettagli tecnici

Item TMS_200X160

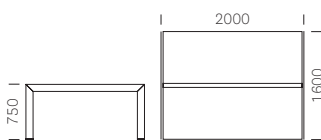

Item TMS_350X160

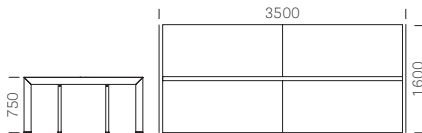

Accessori - Fittings

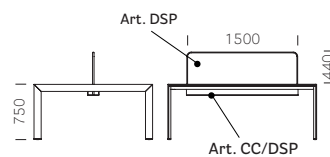

Accessori - Fittings

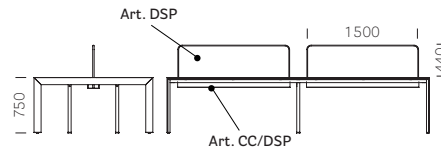

Laminate top finishes
Finiture ripiano in laminato



Frame finish
Finitura telaio



For fabrics see page 306
Per i tessuti si veda a p. 306

MORE

Extensible tables / Tavoli allungabili



| Item Articolo | Frame Telaio Sizes Dimensioni | Finish Finitura | Melamine top included Incluso ripiano in nobilitato | |
|------------------|--|--------------------|--|--|
| | | | BIANCO White (mm 16) | VAT NOT INCLUDED Iva esclusa 22% |
| TMO_110X75 | 1100 → 1600 (X750) | BI | € 1.193,00 | € 977,60 |
| TMO_140X85 | 1400 → 1900 → 2400 (X850) | | € 1.366,00 | € 1.119,30 |
| TMO_180X85 | 1800 → 2300 → 2800 (X850) | | € 1.477,00 | € 1.210,30 |

TECHNICAL DETAILS / Dettagli tecnici

Item TMO_110X75

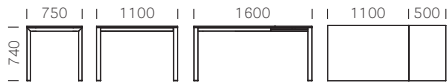

Item TMO_140X85



Item TMO_180X85



Melamine top finish
Finitura ripiano in nobilitato



BIANCO
White

Frame finish
Finitura telaio



BI



| Frame Telaio | | Top Ripiano | Solid laminate top included Incluso ripiano in stratificato | Steel top included Incluso ripiano in lamiera |
|------------------|-----------------------------|---------------------|--|--|
| Item Articolo | Finish Finitura | Sizes Dimensioni | CFP_BI (mm 10) | L (mm 12) |
| 5453 C | POWDER COATED Verniciato | Ø590 | € 301,50 € 247,00 | - - |
| | | Ø600 | - | € 311,00 € 254,80 |
| 5453 H480 C | POWDER COATED Verniciato | Ø590 | € 285,50 € 234,00 | - - |
| | | Ø600 | - | € 295,00 € 241,80 |
| 5454 C | POWDER COATED Verniciato | Ø690 | € 358,00 € 293,15 | - - |
| | | 690X690 | € 358,00 € 293,15 | - - |
| | | 700X700 | - | € 328,50 € 269,10 |

Prices in bold are VAT included (VAT 22%)

I prezzi in grassetto si intendono IVA inclusa (IVA 22%)

TECHNICAL DETAILS / Dettagli tecnici

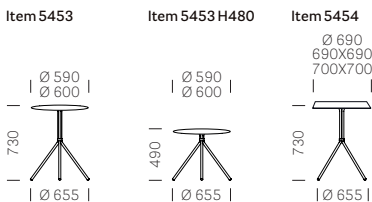

Solid laminate top finish Finitura ripiano in stratificato



CFP_BI

Table base finish Finitura basamento



BI200E

Steel tops Ripiani in lamiera



BI200E GI100E AR500E RO200E TEE GAE BE200E AZ100E VE100E VE300E

Table base finishes Finiture basamento



BI200E GI100E AR500E RO200E TEE GAE BE200E AZ100E VE100E VE300E

PARENTHESIS

Coffee tables / Tavolini



| Item Articolo | Frame Telaio | | Top Ripiano | Solid laminate top included Incluso ripiano in stratificato | | | VAT NOT INCLUDED Iva esclusa 22% |
|------------------|------------------|---------------------|------------------|--|-------------------|-------------------|--|
| | Item Articolo | Sizes Dimensioni | | Finish Finitura | CFP_BI (mm 10) | FNP_NE (mm 10) | |
| P10001 C | Ø 425X450h | RS/BI | D_40_CFP_BI | € 628,50 | - | - | € 514,80 |
| | | AN | D_40_FNP_NERO | - | € 628,50 | - | |
| | | GC | D_40_COP_234 | - | - | € 647,50 | |
| P10002 C | Ø 425X640h | RS/BI | D_40_CFP_BI | € 685,50 | - | - | € 561,60 |
| | | AN | D_40_FNP_NERO | - | € 685,50 | - | |
| | | GC | D_40_COP_234 | - | - | € 704,50 | |
| P10005 C | Ø 730X300h | RS/BI | D_70_CFP_BI | € 680,50 | - | - | € 557,70 |
| | | AN | D_70_FNP_NERO | - | € 680,50 | - | |
| | | GC | D_70_COP_234 | - | - | € 617,00 | |
| P10006 C | 1200X300h | RS/BI | 0117X70_CFP_BI | € 737,50 | - | - | € 604,50 |
| | | AN | 0117X70_FNP_NERO | - | € 737,50 | - | |
| | | GC | 0117X70_COP_234 | - | - | € 823,50 | |

TECHNICAL DETAILS / Dettagli tecnici

Item P10001

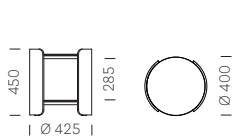

Item P10002

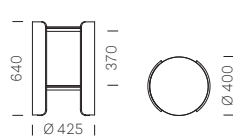

Item P10005

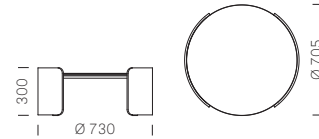

Item P10006

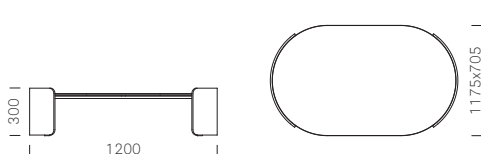

Solid laminate top finishes Finiture ripiano in stratificato

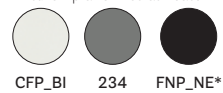

*Anti-fingerprint finish
Finitura anti-impronta

Frame finishes Finiture telaio



PARENTHESIS marble

Coffee tables / Tavolini



| Item Articolo | Frame Telaio | | Top Ripiano Item Articolo | Marble top included Incluso ripiano in marmo | | VAT NOT INCLUDED Iva esclusa 22% |
|------------------|---------------------|--------------------|------------------------------------|---|----------------|--|
| | Sizes Dimensioni | Finish Finitura | | MBA (mm 20) | MGC (mm 20) | |
| P10001 C | Ø 425X450h | RS | D_40 | € 815,50 | - | € 668,20 |
| | | AN | | - | € 815,50 | |
| P10002 C | Ø 425X640h | RS | D_40 | € 872,50 | - | € 715,00 |
| | | AN | | - | € 872,50 | |
| P10005 C | Ø 730X300h | RS | D_70 | € 912,00 | - | € 747,50 |
| | | AN | | - | € 912,00 | |
| P10006 C | 1200X300h | RS | 0117X70 | € 1.380,00 | - | € 1.131,00 |
| | | AN | | - | € 1.380,00 | |

TECHNICAL DETAILS / Dettagli tecnici

Item P10001

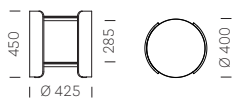

Item P10002

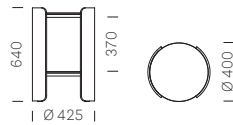

Item P10005

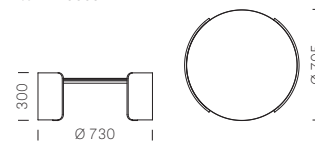

Item P10006

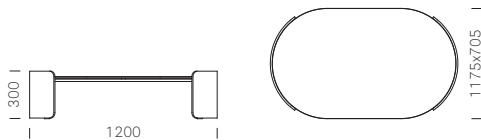

Marble top finishes Finiture ripiano in marmo

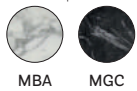

Frame finishes Finiture telaio



PLANO

Fixed tables / Tavoli fissi



| Frame only Solo telaio | | | | | Solid laminate top included Incluso ripiano in stratificato | | | | | | |
|---------------------------|---------------------|--------------------------|-------------------|--------------------|--|-------------------|--|------------------------------------|--|------------|------------|
| Item Articolo | Sizes Dimensioni | Table bases Basamenti | Cross Crociera | Finish Finitura | Cable management Canalina | CFC_BI (mm 10) | VAT NOT INCLUDED Iva esclusa 22% | COI 263 Bianco White (mm 12) | VAT NOT INCLUDED Iva esclusa 22% | | |
| PLO_240X120CC | 2400X1200 | N.2. ART.4431 | 4016 | AC | With cable management Con canalina | € 2.463,50 | € 2.018,90 | € 1.992,50 | € 1.632,80 | | |
| PLO_240X140CC | 2400X1400 | | | | | € 2.691,50 | € 2.206,10 | € 2.154,00 | € 1.765,40 | | |
| PLO_300X120CC | 3000X1200 | | | | | € 3.053,50 | € 2.502,50 | € 2.444,50 | € 2.003,30 | | |
| PLO_300X140CC | 3000X1400 | | | | | € 3.324,50 | € 2.724,80 | € 2.706,00 | € 2.217,80 | | |
| PLO_360X120CC | 3600X1200 | | | | | € 3.691,00 | € 3.025,10 | € 3.027,00 | € 2.481,05 | | |
| PLO_360X140CC | 3600X1400 | | | | | € 4.100,00 | € 3.360,50 | € 3.243,50 | € 2.658,50 | | |
| PLO_240X120 | 2400X1200 | | | | Without cable management Senza canalina | 4016 | AC | € 2.224,00 | € 1.822,60 | € 1.753,00 | € 1.436,50 |
| PLO_240X140 | 2400X1400 | | | | | | | € 2.452,00 | € 2.009,80 | € 1.914,50 | € 1.569,10 |
| PLO_300X120 | 3000X1200 | | | | | | | € 2.614,00 | € 2.142,40 | € 2.005,00 | € 1.643,20 |
| PLO_300X140 | 3000X1400 | | | | | | | € 2.885,00 | € 2.364,70 | € 2.266,50 | € 1.857,70 |
| PLO_360X120 | 3600X1200 | | | | | | | € 3.085,00 | € 2.528,50 | € 2.421,50 | € 1.984,45 |
| PLO_360X140 | 3600X1400 | | | | | | | € 3.494,00 | € 2.863,90 | € 2.638,00 | € 2.161,90 |
| PLR_240X120CC | 2400X1200 | N.2. ART.4491 | 4016 | AC | With cable management Con canalina | € 2.607,50 | € 2.137,20 | € 2.136,50 | € 1.751,10 | | |
| PLR_240X140CC | 2400X1400 | | | | | € 2.836,00 | € 2.324,40 | € 2.298,50 | € 1.883,70 | | |
| PLR_300X120CC | 3000X1200 | | | | | € 3.197,50 | € 2.620,80 | € 2.588,50 | € 2.121,60 | | |
| PLR_300X140CC | 3000X1400 | | | | | € 3.469,00 | € 2.843,10 | € 2.850,50 | € 2.336,10 | | |
| PLR_360X120CC | 3600X1200 | | | | | € 3.835,00 | € 3.143,40 | € 3.171,50 | € 2.599,35 | | |
| PLR_360X140CC | 3600X1400 | | | | | € 4.244,50 | € 3.478,80 | € 3.388,00 | € 2.776,80 | | |
| PLR_240X120 | 2400X1200 | | | | Without cable management Senza canalina | 4016 | AC | € 2.368,00 | € 1.940,90 | € 1.897,00 | € 1.554,80 |
| PLR_240X140 | 2400X1400 | | | | | | | € 2.596,50 | € 2.128,10 | € 2.059,00 | € 1.687,40 |
| PLR_300X120 | 3000X1200 | | | | | | | € 2.758,50 | € 2.260,70 | € 2.149,50 | € 1.761,50 |
| PLR_300X140 | 3000X1400 | | | | | | | € 3.029,50 | € 2.483,00 | € 2.411,00 | € 1.976,00 |
| PLR_360X120 | 3600X1200 | | | | | | | € 3.229,50 | € 2.646,80 | € 2.565,50 | € 2.102,75 |
| PLR_360X140 | 3600X1400 | | | | | | | € 3.638,50 | € 2.982,20 | € 2.782,00 | € 2.280,20 |

TECHNICAL DETAILS / Dettagli tecnici

Rectangular top version / Versione con ripiano rettangolare (PLR)

Oval top version / Versione con ripiano ovale (PLO)

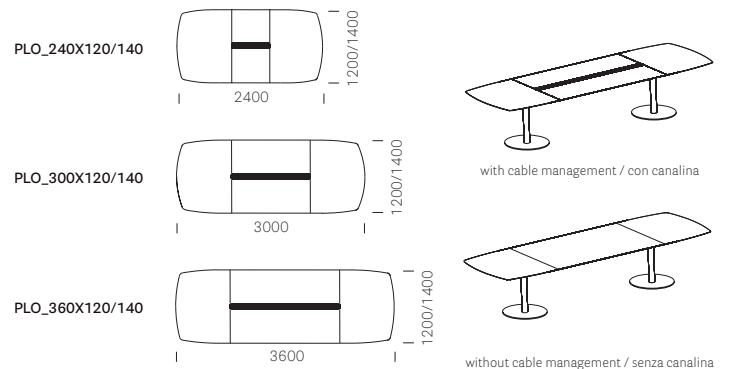
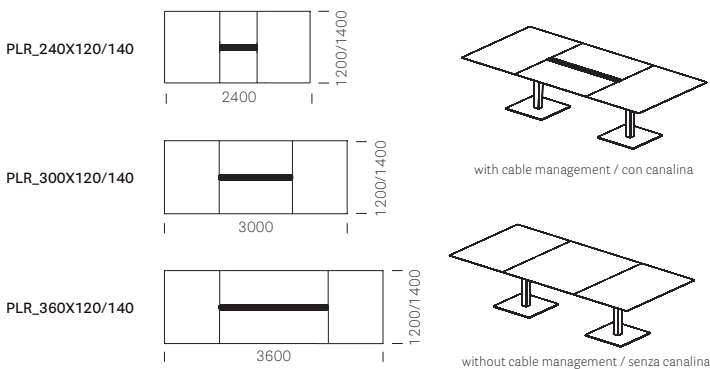

PLANO2

Fixed tables / Tavoli fissi



| Item Articolo | Sizes Dimensioni | Frame Telaio | | | Solid laminate top included Incluso ripiano in stratificato | | | | | |
|------------------|---------------------|--------------------------|-------------------|--------------------|--|-------------------|--|--|-------------------|------------|
| | | Table bases Basamenti | Cross Crociera | Finish Finitura | Cable management Canalina | CFC_BI (mm 6) | VAT NOT INCLUDED Iva esclusa 22% | | | |
| PL2_240X120 CC | 2400X1200 | N.2. ART.4490 | SPEC | BI | With cable management Con canalina 42 mm (CC) | € 2.574,50 | € 2.109,90 | | | |
| PL2_300X120 CC | 3000X1200 | | | | | € 2.758,50 | € 2.260,70 | | | |
| PL2_360X120 CC | 3600X1200 | | | | | € 3.224,50 | € 2.642,90 | | | |
| PL2_240X120 | 2400X1200 | | | | N.2. ART.4491 | SPEC | AC | Without cable management Senza canalina | € 2.254,00 | € 1.847,30 |
| PL2_300X120 | 3000X1200 | | | | | | | | € 2.438,00 | € 1.998,10 |
| PL2_360X120 | 3600X1200 | | | | | | | | € 2.904,00 | € 2.380,30 |
| PL2_240X120 CC | 2400X1200 | N.2. ART.4491 | SPEC | AC | With cable management Con canalina 42 mm (CC) | € 2.733,00 | € 2.239,90 | | | |
| PL2_300X120 CC | 3000X1200 | | | | | € 2.917,00 | € 2.390,70 | | | |
| PL2_360X120 CC | 3600X1200 | | | | | € 3.383,00 | € 2.772,90 | | | |
| PL2_240X120 | 2400X1200 | | | | Without cable management Senza canalina | € 2.412,50 | € 1.977,30 | | | |
| PL2_300X120 | 3000X1200 | | | | | € 2.596,50 | € 2.128,10 | | | |
| PL2_360X120 | 3600X1200 | | | | | € 3.063,00 | € 2.510,30 | | | |

(*) On request 60 mm width (CC60) cable management also available - same price
Disponibile a richiesta il tavolo con canalina larghezza 60 mm (CC60) allo stesso prezzo

TECHNICAL DETAILS / Dettagli tecnici

With cable management / Con canalina

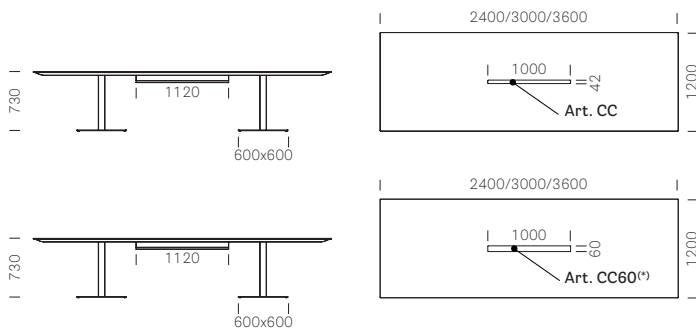

Without cable management / Senza canalina

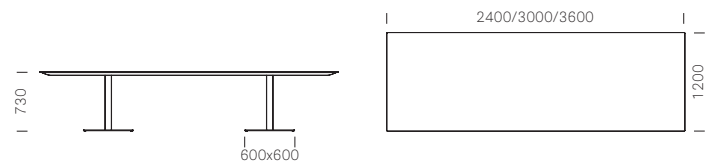

Solid laminate top finish
Finitura ripiano in stratificato



Frame finishes
Finiture telaio



SIDE-TABLE

Coffee tables / Tavolini



| Frame (mm Ø16) Telaio | | | Methacrylate top included Incluso ripiano in metacrilato | |
|--------------------------|--------------|--------------------|---|--|
| Item Articolo | Base Base | Finish Finitura | White Bianco (mm 6) | VAT NOT INCLUDED Iva esclusa 22% |
| 5900 | 460X455 | BI100 | € 205,00 | € 167,70 |

TECHNICAL DETAILS / Dettagli tecnici
Item 5900



| Frame only Solo telaio | | | Laminated top included Incluso ripiano in laminato | | |
|---------------------------|--------------|--------------------|---|----------------------------------|--|
| Item Articolo | Base Base | Finish Finitura | Item Articolo | ABET 312, 1813_244 (mm 20) | VAT NOT INCLUDED Iva esclusa 22% |
| TST_45X45 | 450X450 | ST | _46X46 BA 20 | € 289,50 | € 237,25 |

TECHNICAL DETAILS / Dettagli tecnici
Item TST_45X45



Methacrylate top finishes
Finitura ripiano in metacrilato



Laminate top finishes
Finiture ripiano in laminato



Frame finishes
Finiture telaio



SNOW

Fixed tables / Tavoli fissi



| Frame Telaio | | | Polypropylene top included Incluso ripiano in polipropilene | |
|------------------|---------------------|--------------------|--|--|
| Item Articolo | Sizes Dimensioni | Finish Finitura | BI | VAT NOT INCLUDED Iva esclusa 22% |
| 301 | 800X800X745 | BI | € 208,00 | € 170,30 |

TECHNICAL DETAILS / Dettagli tecnici

Item 301

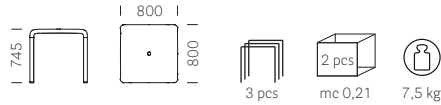

Polypropylene colour
Colore polipropilene



BI

Aluminium finish
Finitura alluminio



BI

SNOW junior

Fixed tables / Tavoli fissi



| Frame Telaio | | | Polypropylene top included Incluso ripiano in polipropilene | |
|------------------|---------------------|--------------------|--|--|
| Item Articolo | Sizes Dimensioni | Finish Finitura | BI | VAT NOT INCLUDED Iva esclusa 22% |
| 301 JR | 800X800X580 | BI | € 208,00 | € 170,30 |

TECHNICAL DETAILS / Dettagli tecnici

Item 301 JR

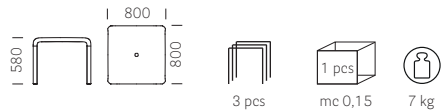

Polypropylene colour
Colore polipropilene



BI

Aluminium finish
Finitura alluminio



BI

STYLUS

Fixed tables / Tavoli fissi



Rounded corners
Angoli raggiati



| Frame Telaio | | Top Ripiano | Solid laminate top included Incluso ripiano in stratificato | | |
|------------------|-----------------------------|---------------------|--|-----------------------------|-----------------------------|
| Item Articolo | Finish Finitura | Sizes Dimensioni | CFC_BI (mm 10) | COL_NE (mm 12) | FNP_NE (mm 10) |
| 5400 C | POWDER COATED Verniciato | 590x590 | € 380,00 € 311,35 | € 286,50 € 234,78 | € 371,50 € 304,33 |
| | | 690x690 | € 440,50 € 360,75 | € 330,50 € 270,53 | € 432,00 € 353,73 |
| 5410 C | POWDER COATED Verniciato | 890x890 | € 655,50 € 537,29 | € 516,00 € 422,89 | € 647,00 € 530,14 |

Prices in bold are VAT included (VAT 22%)

I prezzi in grassetto si intendono IVA inclusa (IVA 22%)

TECHNICAL DETAILS / Dettagli tecnici

Item 5400

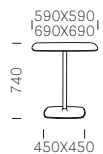

Item 5410

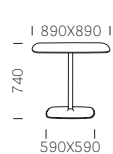

Solid laminate top finishes

Finiture ripiani in stratificato



*Anti-fingerprint finish
Finitura anti-impronta

Table base finishes

Finiture basamento



STYLUS

Fixed tables / Tavoli fissi



| Frame Telaio | | Top Ripiano | Solid laminate top included Incluso ripiano in stratificato | | |
|------------------|-----------------------------|---------------------|--|-----------------------------|-----------------------------|
| Item Articolo | Finish Finitura | Sizes Dimensioni | CFC_BI (mm 10) | COL_NE (mm 12) | FNP_NE (mm 10) |
| 5402 C | POWDER COATED Verniciato | Ø690 | € 410,00 € 336,05 | € 310,50 € 254,15 | € 396,00 € 324,35 |
| 5402 H500 C | POWDER COATED Verniciato | Ø690 | € 418,00 € 342,55 | € 318,00 € 260,65 | € 404,00 € 330,85 |

Prices in bold are VAT included (VAT 22%)
I prezzi in grassetto si intendono IVA inclusa (IVA 22%)

TECHNICAL DETAILS / Dettagli tecnici

Item 5402

Item 5402 H500

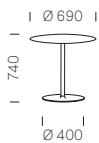

Solid laminate top finishes

Finiture ripiani in stratificato



*Anti-fingerprint finish
Finitura anti-impronta

Table base finishes

Finiture basamento



SPACE

Fixed tables / Tavoli fissi



| Item Articolo | Sizes Dimensioni | Finish Finitura | Frame only Solo telaio | Top Ripiano | Glass top included Incluso ripiano in vetro | | |
|------------------|---------------------|--------------------|---------------------------|------------------|--|----------------|---|
| | | | | Item Articolo | TRA (mm 12) | SAT (mm 12) | VAT NOT INCLUDED Iva esclusa 22% |
| TS_160X90 | 1600X900 | AC | | 160X90 TRA TS | € 1.396,00 | - | € 1.144,00 |
| | | | | 200X90 TRA TS | € 1.554,50 | - | € 1.274,00 |
| TS_200X90 | 2000X900 | AC | | 200X90 SAT TS | - | € 1.602,00 | € 1.313,00 |
| | | | | | | | |

TECHNICAL DETAILS / Dettagli tecnici

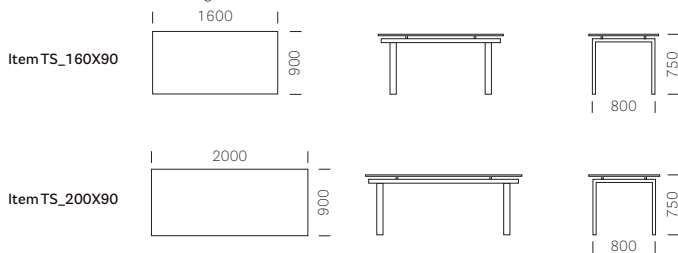

Glass top finishes Finiture ripiano in vetro

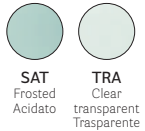

Frame finish Finitura telaio



SURFACE

Extensible tables / Tavoli allungabili



| Item Articolo | Frame Telaio | Sizes Dimensioni | Finish Finitura | Top included Incluso ripiano | |
|------------------|-----------------|---------------------------|--------------------|---------------------------------|---|
| | | | | RS - W - N - BI | VAT NOT INCLUDED Iva esclusa 22% |
| TSU2_188X90 | | 1880 → 2380 → 2880 (X900) | RS - W - N - BI | € 3.093,00 | € 2.535,00 |

TECHNICAL DETAILS / Dettagli tecnici

Item TSU2_188X90

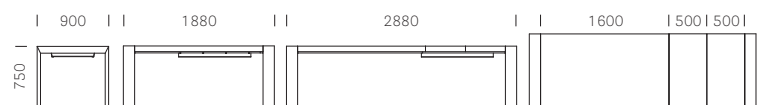

Finishes Finiture

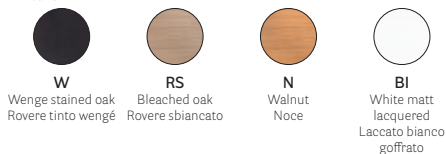



| Frame only Solo telaio | | Top Ripiano | Solid laminate top included Incluso ripiano in stratificato | | Laminate top included Incluso ripiano in laminato |
|---------------------------|--------------------|---------------------|--|-------------------------------|--|
| Item Articolo | Finish Finitura | Sizes Dimensioni | COM black nero, (mm 12) | CFC_BI (mm 10) | ABET 421, 263 (mm 30) |
| TG | BI/NERO | 790X790 | € 471,50 € 386,10 | € 562,50 € 460,85 | € 421,50 € 345,15 |
| | | 1190X790 | € 646,00 € 529,10 | € 780,50 € 639,60 | € 492,50 € 403,65 |
| | | 1390X890 | € 739,50 € 605,80 | € 966,00 € 791,70 | € 562,50 € 460,85 |
| | | 1590X890 | € 850,50 € 696,80 | € 1.018,50 € 834,60 | € 585,50 € 479,70 |

Prices in bold are VAT included (VAT 22%)
I prezzi in grassetto si intendono IVA inclusa (IVA 22%)

TECHNICAL DETAILS / Dettagli tecnici

Item TG



Solid laminate top finishes Finiture ripiani in stratificato



CFC_BI COM_NE

Laminate top finishes Finiture ripiani in laminato



421 263

Frame finishes Finiture telaio



BI NERO

YPSILON - YPSILON 4

Fixed tables / Tavoli fissi



4790



4797



4795

| Item Articolo | Frame Telaio Finish Finitura | Top Ripiano Sizes Dimensioni | Solid laminate top included Incluso ripiano in stratificato | | Steel top included Incluso ripiano in lamiera | | Glass top included Incluso ripiano in vetro | |
|------------------|--|---------------------------------------|--|-------------------------------|---|-----------------------------|--|-----------------------------|
| | | | CFC_BI (mm 10) | FNP_NE (mm 10) | BI200E, VE100E, GI100E, AZ100E, RO200E (mm 12) | NERO (mm 12) | BIA (mm 10) | NER (mm 10) |
| 4790/AA C | ANODIZED ALUMINIUM Alluminio anodizzato | Ø690 | € 500,50 € 410,15 | € 500,50 € 410,15 | - | - | - | - |
| 4790/LU C | POLISHED ALUMINIUM Alluminio lucidato | Ø690 | € 469,00 € 384,15 | € 469,00 € 384,15 | - | - | - | - |
| 4795/LU C | POLISHED ALUMINIUM Alluminio lucidato | Ø1290 | € 1.095,00 € 897,52 | € 1.095,00 € 897,52 | - | - | - | - |
| | | 890x890 | € 601,00 € 492,57 | € 601,00 € 492,57 | - | - | - | - |
| 4795 C | POWDER COATED Verniciato | Ø1290 | € 1.112,00 € 911,30 | € 1.074,00 € 880,10 | - | - | - | - |
| | | 890x890 | € 618,00 € 506,35 | € 580,00 € 475,15 | - | - | - | - |
| 4797 C | POWDER COATED Verniciato | 700x700 | - | - | € 417,50 € 341,90 | € 385,50 € 315,90 | - | - |
| | | 790x790 | € 499,00 € 408,85 | € 467,50 € 382,85 | - | - | - | - |
| | | 800x800 | - | - | € 465,00 € 380,90 | € 433,00 € 354,90 | - | - |
| 4797V H500 C | POWDER COATED Verniciato | Ø900 | - | - | - | - | € 522,00 € 427,70 | € 506,00 € 414,70 |

Prices in bold are VAT included (VAT 22%)
I prezzi in grassetto si intendono IVA inclusa (IVA 22%)

TECHNICAL DETAILS / Dettagli tecnici

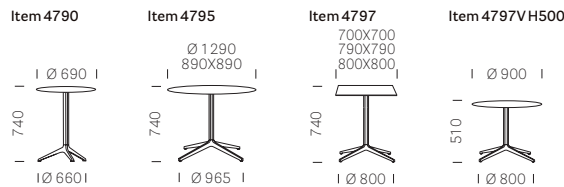

Solid laminate top finishes
Finiture ripiani in stratificato

*Anti-fingerprint finish
Finitura anti-impronta

CFC_BI FNP_NE*

Steel top finishes
Finiture ripiani in lamiera

BI200E VE100E GI100E AZ100E RO200E NERO

Glass top finishes
Finiture ripiani in vetro

BIA NER

Table base finishes
Finiture basamento

BI200E NERO LU AA

Table base finishes
Finiture basamento

BI200E VE100E GI100E AZ100E RO200E NERO

Table base finishes
Finiture basamento

BI NERO

YPSILON Tilting

Tilting tables / Tavoli ribaltabili



| Item Articolo | Frame Telaio | Top Ripiano | Solid laminate top included Incluso ripiano in stratificato | | | Laminate top included Incluso ripiano in laminato | |
|------------------|--|----------------|--|--|---|--|--|
| | | | CFP_BI (mm 12) white core anima bianca | COP_623 (mm 10) black core anima nera | FNP_NE (mm 10) black core anima nera | COP 4511, 4512, 4517, 4519, 4529, 4543 (mm 10) brown core anima marrone | BA_20 406_0020, 421, 4511, 4512, 4517, 4519, 4529, 4543 (mm 20) |
| TYT 119X79 C | POWDER COATED Verniciato | 1190x790 | € 928,00 € 760,50 | € 899,50 € 737,10 | € 769,50 € 630,50 | € 626,50 € 513,50 | |
| | POLISHED ALUMINIUM Alluminio lucidato | | € 1.023,00 € 838,50 | € 994,50 € 815,10 | € 864,50 € 708,50 | € 722,00 € 591,50 | |
| TYT 129X79 C | POWDER COATED Verniciato | 1290x790 | € 975,50 € 799,50 | € 947,00 € 776,10 | € 801,00 € 656,50 | € 626,50 € 513,50 | |
| | POLISHED ALUMINIUM Alluminio lucidato | | € 1.071,00 € 877,50 | € 1.042,00 € 854,10 | € 896,50 € 734,50 | € 722,00 € 591,50 | |
| TYT 139X89 C | POWDER COATED Verniciato | 1390x890 | € 1.063,00 € 871,00 | € 1.023,00 € 838,50 | € 849,00 € 695,50 | € 658,50 € 539,50 | |
| | POLISHED ALUMINIUM Alluminio lucidato | | € 1.158,00 € 949,00 | € 1.118,50 € 916,50 | € 944,00 € 773,50 | € 753,50 € 617,50 | |
| TYT 158X79 C | POWDER COATED Verniciato | 1580x790 | € 1.142,00 € 936,00 | € 1.094,50 € 897,00 | € 896,50 € 734,50 | € 682,00 € 559,00 | |
| | POLISHED ALUMINIUM Alluminio lucidato | | € 1.237,50 € 1.014,00 | € 1.189,50 € 975,00 | € 991,50 € 812,50 | € 777,50 € 637,00 | |
| TYT 159X89 C | POWDER COATED Verniciato | 1590x890 | € 1.142,00 € 936,00 | € 1.094,50 € 897,00 | € 896,50 € 734,50 | € 682,00 € 559,00 | |
| | POLISHED ALUMINIUM Alluminio lucidato | | € 1.237,50 € 1.014,00 | € 1.189,50 € 975,00 | € 991,50 € 812,50 | € 777,50 € 637,00 | |
| TYT 159X99 C | POWDER COATED Verniciato | 1590x990 | € 1.216,50 € 997,10 | € 1.142,00 € 936,00 | € 912,00 € 747,50 | € 761,50 € 624,00 | |
| | POLISHED ALUMINIUM Alluminio lucidato | | € 1.312,00 € 1.075,10 | € 1.237,50 € 1.014,00 | € 1.007,50 € 825,50 | € 856,50 € 702,00 | |
| TYT 178X89 C | POWDER COATED Verniciato | 1780x890 | € 1.253,00 € 1.027,00 | € 1.174,00 € 962,00 | € 936,00 € 767,00 | € 706,00 € 578,50 | |
| | POLISHED ALUMINIUM Alluminio lucidato | | € 1.348,50 € 1.105,00 | € 1.269,00 € 1.040,00 | € 1.031,00 € 845,00 | € 801,00 € 656,50 | |
| TYT 189X99 C | POWDER COATED Verniciato | 1890x990 | € 1.340,50 € 1.098,50 | € 1.253,00 € 1.027,00 | € 999,50 € 819,00 | € 761,50 € 624,00 | |
| | POLISHED ALUMINIUM Alluminio lucidato | | € 1.435,50 € 1.176,50 | € 1.348,50 € 1.105,00 | € 1.094,50 € 897,00 | € 856,50 € 702,00 | |
| TYT 198X99 C | POWDER COATED Verniciato | 1980x990 | € 1.412,00 € 1.157,00 | € 1.324,50 € 1.085,50 | € 1.031,00 € 845,00 | € 761,50 € 624,00 | |
| | POLISHED ALUMINIUM Alluminio lucidato | | € 1.507,00 € 1.235,00 | € 1.419,50 € 1.163,50 | € 1.126,50 € 923,00 | € 856,50 € 702,00 | |

Prices in bold are VAT included (VAT 22%)

I prezzi in grassetto si intendono IVA inclusa (IVA 22%)

On request, version without wheels also available – same price

Disponibile a richiesta il tavolo fisso, senza rotelle, allo stesso prezzo

TECHNICAL DETAILS / Dettagli tecnici

Item TYT 119/129x79



Item TYT 139x89



Item TYT 158x79

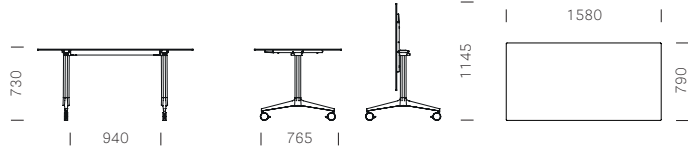

Item TYT 159x89/99

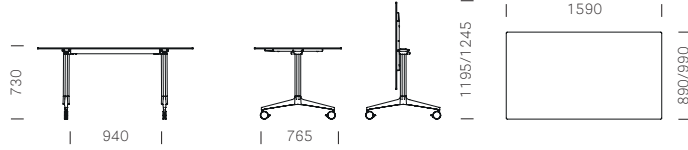

Item TYT 178x89

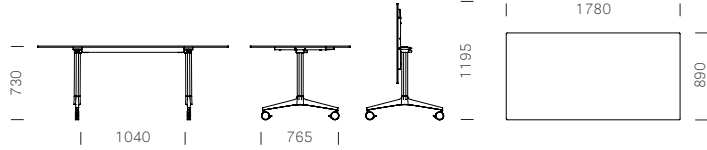

Item TYT 189/198x99

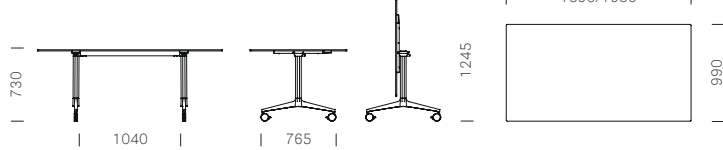

Solid laminate top and powder coated or polished frame finishes

Finiture ripiano in stratificato e telaio verniciato o lucidato

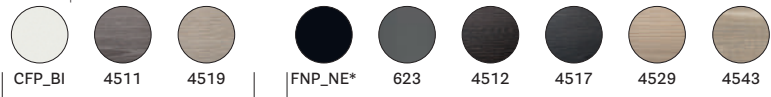

*Anti-fingerprint finish
Finitura anti-impronta



Laminate top and powder coated or polished frame finishes

Finiture ripiano in laminato e telaio verniciato o lucidato

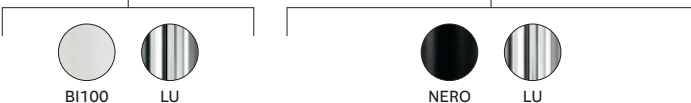
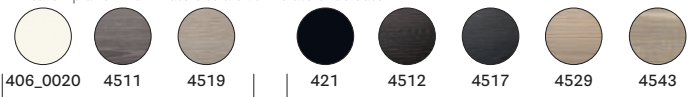

BOXIE

Storage system / Sistema contenitore



| Item Articolo | Frame Telaio | Sizes Dimensioni | Polypropylene tops and drawers Ripiani e cassetti in polipropilene | VAT NOT INCLUDED Iva esclusa 22% |
|------------------|-----------------------------|---------------------|---|--|
| BXL_2C | POWDER COATED Verniciato | 515X530X460h | € 381,00 | € 312,00 |
| BXL_1C | | | € 365,00 | € 299,00 |
| BXM_3C | POWDER COATED Verniciato | 515X530X630h | € 476,00 | € 390,00 |
| BXM_2C | | | € 460,00 | € 377,00 |
| BXH_4C | POWDER COATED Verniciato | 515X530X800h | € 587,00 | € 481,00 |
| BXH_3C | | | € 571,00 | € 468,00 |

CATAS

TECHNICAL DETAILS / Dettagli tecnici

| | | |
|--------------------|--------------------|--------------------|
| <p>Item BXL_2C</p> | <p>Item BXM_3C</p> | <p>Item BXH_4C</p> |
| <p>Item BXL_1C</p> | <p>Item BXM_2C</p> | <p>Item BXH_3C</p> |

Polypropylene and powder coated steel frame colours



FLAG

Coat stand / Appendiabiti



Frame
Telaio

| Item Articolo | Base Base | Height Altezza | Column Colonna | Finish Finitura | Polypropylene colours Colori polipropilene | Price Prezzo | VAT NOT INCLUDED Iva esclusa 22% |
|------------------|--------------|-------------------|-------------------|---|---|-----------------|--|
| 5145 | Ø 400 | 1730 | Ø 35 | BI100 - NERO - BE200 - AR400 - VE500 - RA200 | BI - NE - BE - AR - VE - RA | € 236,50 | € 193,70 |
| 5144B | | | | BI100 - NERO - BE200 - AR400 - VE500 - RA200 | BI - NE - BE - AR - VE - RA | | |

TECHNICAL DETAILS / Dettagli tecnici

Item 5145

Item 5144B

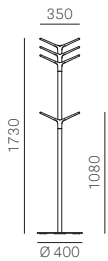
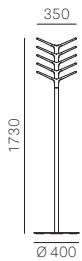

Polypropylene and powder coated steel frame colours

Colori polipropilene e struttura in acciaio verniciato

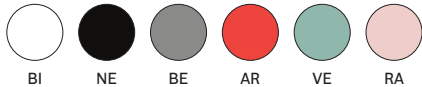

FLAG wall

Coat hanger / Appendiabiti



Frame
Telaio

| Item Articolo | Finish Finitura | Polypropylene colours Colori polipropilene | Price Prezzo | VAT NOT INCLUDED Iva esclusa 22% |
|------------------|------------------------------|---|-----------------|--|
| 5150W4 | BI100 - NERO - BE200 - AR400 | BI - NE - BE - AR | € 98,50 | € 80,60 |
| 5150W8 | | | € 165,00 | € 135,20 |
| 5150W12 | | | € 230,00 | € 188,50 |

TECHNICAL DETAILS / Dettagli tecnici

Item 5150W4

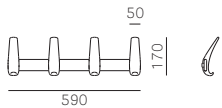

Item 5150W8

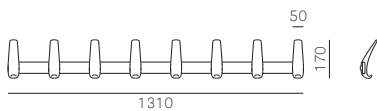

Item 5150W12

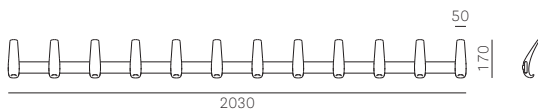

Polypropylene and powder coated steel frame colours

Colori polipropilene e struttura in acciaio verniciato



RAY

Coat hanger / Appendiabiti



Frame
Telaio

| Item Articolo | Base Base | Height Altezza | Column Colonna | Finish Finitura | Price Prezzo | VAT NOT INCLUDED Iva esclusa 22% |
|------------------|--------------|-------------------|-------------------|---|-----------------|--|
| 5166 | Ø 400 | 1715 | Ø 35 | WHITE/BLACK POWDER COATED Verniciato bianco/nero | € 523,50 | € 429,00 |

TECHNICAL DETAILS / Dettagli tecnici

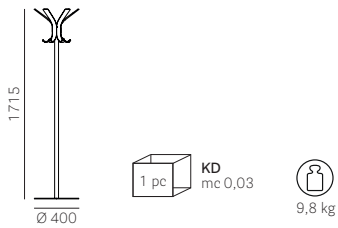

Ash colours Colori frassino

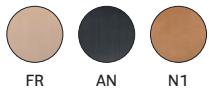



| Item Articolo | Frame Telaio | Polyethylene Polietilene | VAT NOT INCLUDED Iva esclusa 22% |
|------------------|-----------------|-----------------------------|--|
| BRIK | PET | € 205,00 | € 167,70 |
| BRIK4 | PET | € 119,00 | € 97,50 |

TECHNICAL DETAILS / Dettagli tecnici

Item BRIK

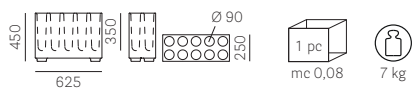

Item BRIK4

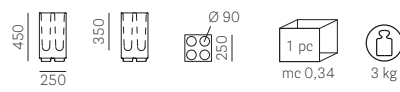

PET colours
Colori PET





| Item Articolo | Frame Telaio | Polyethylene Polietilene | Lighting kit Kit illuminazione | Steel Acciaio | VAT NOT INCLUDED Iva esclusa 22% |
|--|-----------------|-----------------------------|---|------------------|--|
| KADO | PET H600 | € 270,00 | | | € 221,00 |
| KADO2 | PET H1000 | € 412,50 | | | € 338,00 |
| KADO_LUCE Solo kit illuminazione Lighting kit only | | | € 111,50 KADO + KADO_LUCE = € 381,00 | | € 91,00 € 312,00 |
| KADO_FIX Solo kit per fissaggio a terra Floor fixing kit only | | | | € 87,50 | € 71,50 |

TECHNICAL DETAILS / Dettagli tecnici

Item KADO

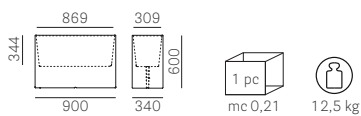

Item KADO2

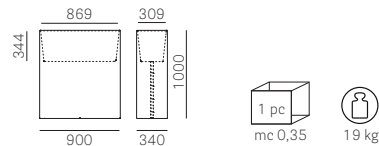

Item KADO_LUCE

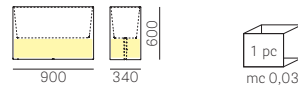

Item KADO_FIX

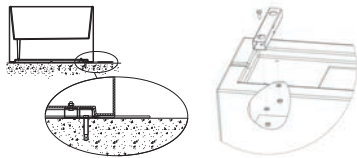

PET colours
Colori PET



SNOOZE

Sound absorbing / Pannello fonoassorbente



| Item Articolo | Finish Finitura | Price Prezzo | VAT NOT INCLUDED Iva esclusa 22% |
|------------------|--------------------|-----------------|--|
| SNZ01P | C83+C101 | € 282,50 | € 231,40 |
| | G21+G25, G110+G116 | € 365,00 | € 299,00 |

TECHNICAL DETAILS / Dettagli tecnici

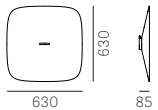

Metal element finish
Finitura elemento metallico



ST

For fabrics see page 306
Per i tessuti si veda a p. 306

EXAMPLES OF COMBINATIONS / ESEMPI DI CONFIGURAZIONI

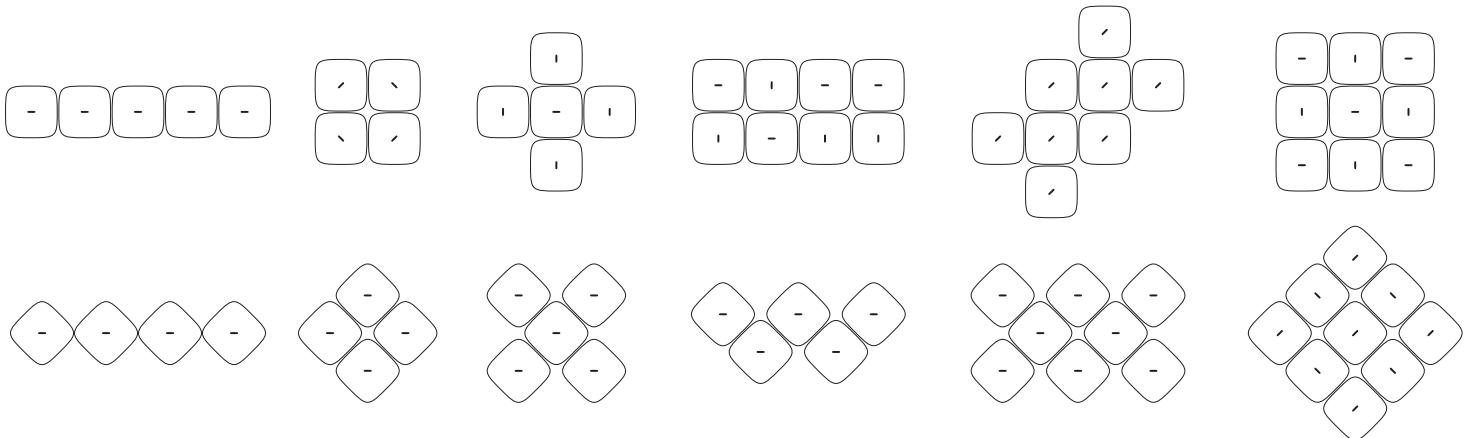

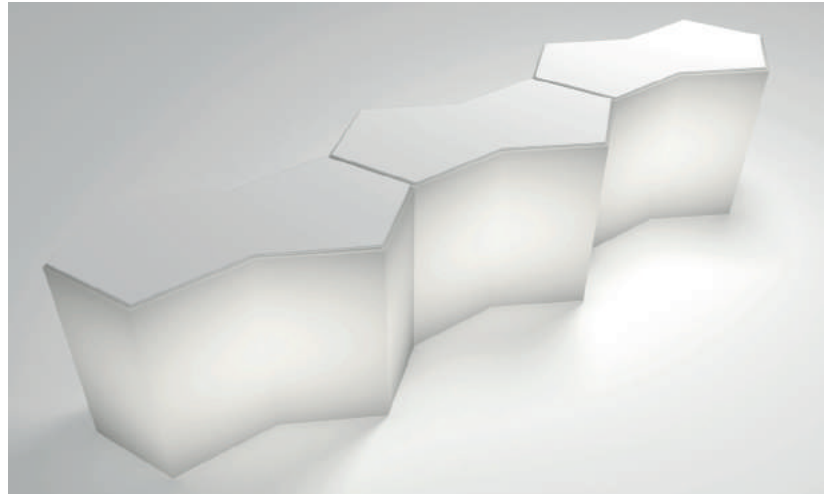

| Item Articolo | Frame Telaio | Polyethylene Polietilene | Lighting kit Kit illuminazione | Methacrylate Metacrilato | White powder coated Verniciato bianco | VAT NOT INCLUDED Iva esclusa 22% |
|---|-----------------|--|-----------------------------------|-----------------------------|--|--|
| IBE_BI | PET | € 1.078,50 | | | | € 884,00 |
| IBE_LUCE Solo kit illuminazione Lighting kit only | | IBE_BI + IBE_LUCE = € 1.304,00 English plug version: upcharge € 48,00 (item IBE_LUCE_UK) Versione con presa britannica: supplemento € 48,00 (Art.IBE_LUCE_UK) | € 225,50 | | | € 184,60 € 1.068,60 € 39,00 |
| IBE_SUP_MET_BI Solo ripiano superiore Upper top only | | IBE_BI + IBE_SUP_MET_BI = € 1.561,50 | | € 483,00 | | € 395,85 € 1.279,85 |
| IBE_INF__BI Solo ripiano inferiore Lower top only | | IBE_BI + IBE_INF__BI = € 1.164,50 | | | € 86,00 | € 70,20 € 954,20 |

TECHNICAL DETAILS / Dettagli tecnici

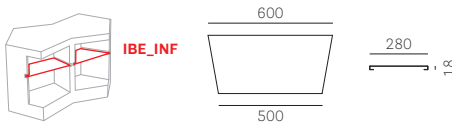
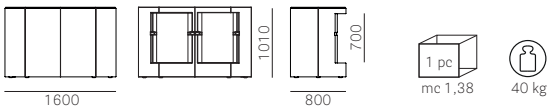

PET colours Colori PET



BI



| Item Articolo | Frame Telaio | Polyethylene Polietilene | Lighting kit Kit illuminazione | Methacrylate Metacrilato | White powder coated Verniciato bianco | VAT NOT INCLUDED Iva esclusa 22% |
|--|--|--|-----------------------------------|-----------------------------|--|--|
| IGL_BI/RIP_BI | PET + Top LBI sp 15 mm White steel top Lamiera bianca | € 1.050,00 | | | | € 860,60 |
| IGL_LUCE Solo kit illuminazione Lighting kit only | | | € 159,00 | | | € 130,00 |
| | | IGL_BI/RIP_BI + IGL_LUCE = € 1.209,00 | | | | € 990,60 |
| IGL_SUP_MET_BI Solo ripiano superiore Upper top only | | | | € 219,00 | | € 179,40 |
| | | IGL_BI/RIP_BI + IGL_SUP_MET_BI = € 1.269,00 | | | | € 1.040,00 |
| K_RIP_INF_BI100E Solo ripiani inferiori Lower tops only | | | | | € 293,50 (Set composed by 3 tops Set composto da 3 ripiani) | € 240,50 |
| | | IGL_BI/RIP_BI + K_RIP_INF_BI100E = € 1.343,50 | | | | € 1.101,10 |

TECHNICAL DETAILS / Dettagli tecnici

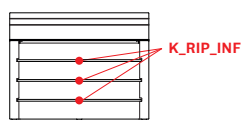
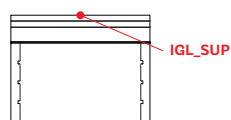
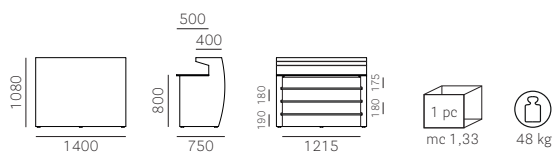

PET colours Colori PET



BI

IGLOO corner



Bar counter / Banco bar



| Item Articolo | Frame Telaio | Polyethylene Polietilene | Lighting kit Kit illuminazione | VAT NOT INCLUDED Iva esclusa 22% |
|---|---|---|-----------------------------------|--|
| IGLC_CORNER | PET + Top LBI White steel top Lamiera bianca | € 921,50 Module to be used only in combination with item IGL_BI/RIP_BI and IGL_WORKSTATION Modulo da utilizzare esclusivamente in abbinamento all'articolo IGL_BI/RIP_BI e IGL_WORKSTATION | | € 755,30 |
| IGLC_LUCE Solo kit illuminazione Lighting kit only | | IGLC_CORNER + IGLC_LUCE = € 1.080,50 | € 159,00 | € 130,00 € 885,30 |

TECHNICAL DETAILS / Dettagli tecnici

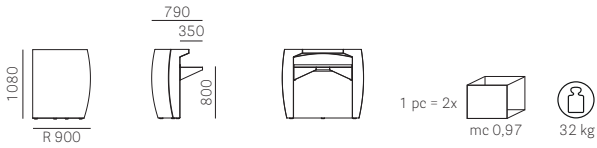

SOME POSSIBLE COMBINATIONS / ALCUNE POSSIBILI CONFIGURAZIONI

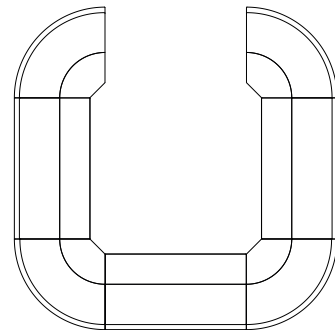
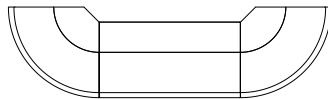
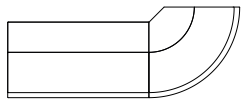

PET colours
Colori PET



BI

IGLOO consolle



Bar counter / Banco bar



| Item Articolo | Frame Telaio | Polyethylene Polietilene | Lighting kit Kit illuminazione | VAT NOT INCLUDED Iva esclusa 22% |
|---|---|---|-----------------------------------|--|
| IGLC_CONSOLLE | PET + Top LBI sp 15 mm White steel top Lamiera bianca | € 1.721,00 | | € 1.410,50 |
| IGLC_LUCE Solo kit illuminazione Lighting kit only | 2x IGLC_LUCE | IGLC_CONSOLLE + 2 x IGLC_LUCE = € 2.038,50 | € 317,50 | € 260,00 € 1.670,50 |

TECHNICAL DETAILS / Dettagli tecnici

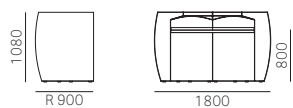

1 pc = 3x
mc 1,85
61 kg

PET colours
Colori PET



BI

IGLOO workstation



Bar counter / Banco bar



| Item Articolo | Frame Telaio | Polyethylene Polietilene | Lighting kit Kit illuminazione | Methacrylate Metacrilato | VAT NOT INCLUDED Iva esclusa 22% |
|--|--|--|-----------------------------------|--|--|
| IGL_WORKSTATION | PET + n° 1 stainless steel work top / piano di lavoro in acciaio inox n° 1 stainless steel tray with holes for ice / contenitore portaghiaccio formato in acciaio inox n° 5 five trays for fresh fruit / contenitori porta frutta in acciaio inox n° 1 polyethylene cutting board / tagliere in polietilene n° 1 white powder coated bottle carrier / portabottiglie verniciato bianco n° 1 stainless steel liquid recovery tank (kit for drainage included) / vasca di recupero liquidi in acciaio inox (kit raccordi per scarico inclusi) | € 2.466,50 | | | € 2.021,50 |
| IGL_LUCE Solo kit illuminazione Lighting kit only | | IGL_WORKSTATION + IGL_LUCE = € 2.625,00 | € 159,00 | | € 130,00 € 2.151,50 |
| IGL_SUP_MET_BI Solo ripiano superiore Upper top only | | IGL_WORKSTATION + IGL_SUP_MET_BI = € 2.685,50 | | € 219,00 | € 179,40 € 2.200,90 |
| K_RIP_INF_BI100E Solo ripiani inferiori Lower tops only | | IGL_WORKSTATION + K_RIP_INF_BI100E = € 2.760,00 | | € 293,50 (Set composed by 3 tops Set composto da 3 ripiani) | € 240,50 € 2.262,00 |

TECHNICAL DETAILS / Dettagli tecnici

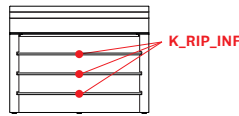
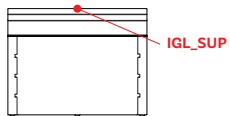
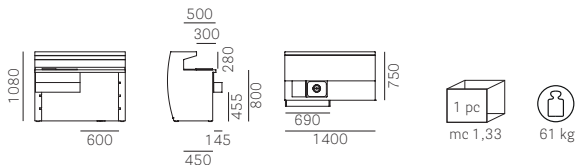

PET colours Colori PET



BI



| Item Articolo | Frame Telaio | Polyethylene Polietilene | Lighting kit Kit illuminazione | Methacrylate Metacrilato | White powder coated Verniciato bianco | VAT NOT INCLUDED Iva esclusa 22% |
|--|-----------------|--|-----------------------------------|-----------------------------|--|--|
| OBL_BI | PET | € 1.047,00 | | | | € 858,00 |
| IGL_LUCE Solo kit illuminazione Lighting kit only | | | € 159,00 | | | € 130,00 |
| | | OBL_BI + IGL_LUCE = € 1.205,50 | | | | € 988,00 |
| OBL_SUP_MET_BI Solo ripiano superiore Upper top only | | | | € 219,00 | | € 179,40 |
| | | OBL_BI + IGL_LUCE + OBL_SUP_MET_BI = € 1.424,50 | | | | € 1.167,40 |
| OBL_RIP_MET_BI Solo ripiano superiore Upper top only | | | | € 270,00 | | € 221,00 |
| | | OBL_BI + IGL_LUCE + OBL_RIP_MET_BI = € 1.475,00 | | | | € 1.209,00 |
| | | OBL_BI + IGL_LUCE + OBL_SUP_MET_BI + OBL_RIP_MET_BI = € 1.694,00 | | | | € 1.388,40 |
| K_RIP_INF_BI100E Solo ripiani inferiori Lower tops only | | | | | € 293,50 (Set composed by 3 tops Set composto da 3 ripiani) | € 240,50 |
| | | OBL_BI + IGL_LUCE + K_RIP_INF_BI100E = € 1.499,00 | | | | € 1.228,50 |
| | | OBL_BI + IGL_LUCE + OBL_RIP_MET_BI + OBL_SUP_MET_BI + K_RIP_INF_BI100E = € 1.987,50 | | | | € 1.628,90 |

TECHNICAL DETAILS / Dettagli tecnici

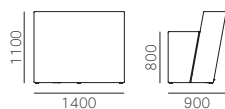

Adjustable feet included
Piedini regolabili inclusi

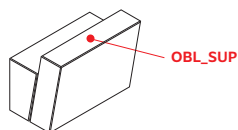

OBL_SUP

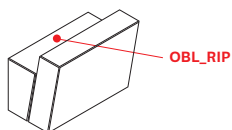
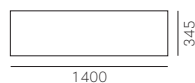

OBL_RIP

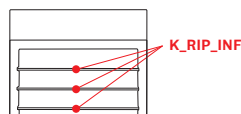

K_RIP_INF



PET colours Colori PET



BI

OBLIQUE soft

Bar counter / Banco bar



| Item Articolo | Frame Telaio | Smooth Liscio | Stitches Cuciture | White powder coated Verniciato bianco | Black powder coated Verniciato nero | VAT NOT INCLUDED Iva esclusa 22% |
|--|--|-------------------|----------------------|--|--|--|
| OBL/A | BI + TOP (sp 8 mm) upper and work top in white methacrylate ripiano superiore e di lavoro in metacrilato bianco H20 | € 2.347,50 | € 2.347,50 | | | € 1.924,00 |
| K_RIP_INF_BI100E Solo ripiani inferiori Lower tops only | | | | € 293,50 (Set composed by 3 tops Set composto da 3 ripiani) | | € 240,50 |
| OBL/A | GA + TOP (sp 8 mm) upper and work top in black methacrylate ripiano superiore e di lavoro in metacrilato nero H26 | € 2.452,00 | € 2.452,00 | | | € 2.009,80 |
| K_RIP_INF_NPE Solo ripiani inferiori Lower tops only | | | | | € 293,50 (Set composed by 3 tops Set composto da 3 ripiani) | € 240,50 |

TECHNICAL DETAILS / Dettagli tecnici

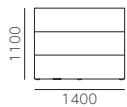

Adjustable feet included
Piedini regolabili inclusi

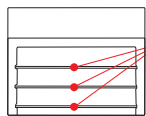

K_RIP_INF



PET colours Colori PET



For fabrics see page 306
Per i tessuti si veda a p. 306

OBLIQUE corner



Bar counter / Banco bar

Complements / Complementi



| Item Articolo | Frame Telaio | Polyethylene Polietilene | Lighting kit Kit illuminazione | Methacrylate Metacrilato | VAT NOT INCLUDED Iva esclusa 22% |
|---|-----------------|---|-----------------------------------|-----------------------------|--|
| OBA_BI | PET | € 888,50 | | | € 728,00 |
| TTS_LUCE Solo kit illuminazione Lighting kit only | | OBA_BI + TTS_LUCE = € 1.063,00 | € 174,50 | | € 143,00 € 871,00 |
| OBA_SUP_MET_BI Solo ripiano superiore Upper top only | | OBA_BI + TTS_LUCE + OBA_SUP_MET_BI = € 1.375,50 | | € 312,50 | € 256,10 € 1.127,10 |
| OBA_RIP_MET_BI Solo ripiano superiore Upper top only | | OBA_BI + TTS_LUCE + OBA_RIP_MET_BI = € 1.269,00 OBA_BI + TTS_LUCE + OBA_SUP_MET_BI + OBA_RIP_MET_BI = € 1.581,50 | | € 206,50 | € 169,00 € 1.040,00 € 1.296,10 |

TECHNICAL DETAILS / Dettagli tecnici

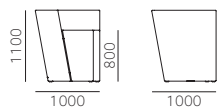

Adjustable feet included
Piedini regolabili inclusi

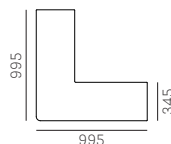
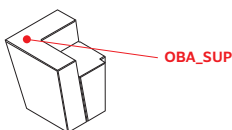
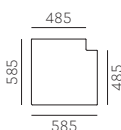
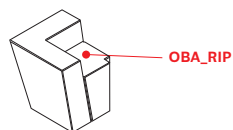

PET colours Colori PET



BI

OBLIQUE corner soft

Bar counter / Banco bar



| Item Articolo | Frame Telaio | Smooth Liscio | Stitches Cuciture | VAT NOT INCLUDED Iva esclusa 22% |
|------------------|---|-------------------|----------------------|--|
| OBA/A | BI + TOP (sp 8 mm) upper and work top in white methacrylate ripiano superiore e di lavoro in metacrilato bianco H20 | € 2.799,50 | € 2.799,50 | € 2.294,50 |
| OBA/A | GA + TOP (sp 8 mm) upper and work top in black methacrylate ripiano superiore e di lavoro in metacrilato nero H26 | € 2.888,50 | € 2.888,50 | € 2.367,30 |

TECHNICAL DETAILS / Dettagli tecnici

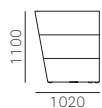

Adjustable feet included
Piedini regolabili inclusi

PET colours Colori PET



For fabrics see page 306
Per i tessuti si veda a p. 306



| Item Articolo | Frame Telaio | Polyethylene Polietilene | Lighting kit Kit illuminazione | Brushed s/steel Inox satinato | White powder coated Verniciato bianco | VAT NOT INCLUDED Iva esclusa 22% |
|--|-----------------|--|-----------------------------------|----------------------------------|--|--|
| TTS_BI | PET | € 1.078,50 | | | | € 884,00 |
| | | When single modules are joint the use of the upper tops is suggested. See page 280 In caso di accostamento dei singoli moduli è consigliato l'utilizzo dei ripiani superiori. Vedere a pagina 280 | | | | |
| TTS_LUCE Solo kit illuminazione Lighting kit only | | | € 174,50 | | | € 143,00 |
| TTS_LED Solo kit illuminazione Lighting kit only | | | € 619,00 | | | € 507,00 |
| TTS_LED_LINK Solo kit illuminazione Lighting kit only | | | € 309,50 | | | € 253,50 |
| | | To link and light up 2 Tetris bar-counter at same time Da utilizzare in abbinamento a TTS_LED per collegare e illuminare contemporaneamente 2 Tetris | | | | |
| TTS_SUP_130/140/150 Solo ripiano superiore Upper top only | | | | € 373,00 | € 373,00 | € 305,50 |
| TTS_SUP_185 Solo ripiano superiore Upper top only | | | | € 389,00 | € 389,00 | € 318,50 |
| TTS_RIP Solo ripiano inferiore Lower top only | | | | € 341,00 | | € 279,50 |
| TTS_INF Solo ripiano inferiore Lower top only | | | | € 214,50 | | € 175,50 |

TECHNICAL DETAILS / Dettagli tecnici

Item TTS_BI

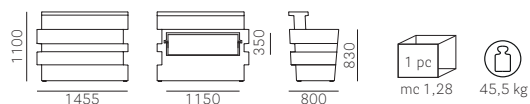

Item TTS_LUCE / TTS_LED

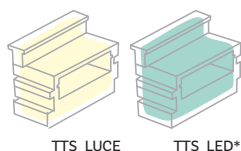

With LED that changes colours: red, yellow, green, violet, blue, light blue.
Wireless controller included.
Con LED che cambiano colore: rosso, giallo, verde, viola, blu, azzurro.
Controllo wireless in dotazione

*LED RGB

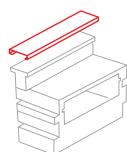

TTS_SUP

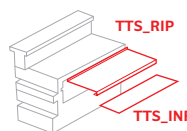
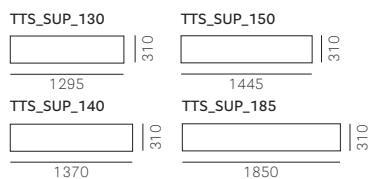

TTS_RIP

TTS_INF

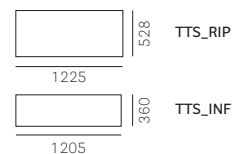

PET colours
Colori PET



BI



| Item Articolo | Frame Telaio | Polyethylene Polietilene | Lighting kit Kit illuminazione | VAT NOT INCLUDED Iva esclusa 22% |
|---|-----------------|---|-----------------------------------|--|
| T TSA_BI | PET | € 856,50 | | € 702,00 |
| T TS_LUCE Solo kit illuminazione Lighting kit only | | | € 174,50 | € 143,00 |
| T TS_LED Solo kit illuminazione Lighting kit only | | | € 619,00 | € 507,00 |
| T TS_LED_LINK Solo kit illuminazione Lighting kit only | | To link and light up 2 Tetris bar-counter at same time Da utilizzare in abbinamento a T TSA_LED per collegare e illuminare contemporaneamente 2 Tetris | € 309,50 | € 253,50 |

TECHNICAL DETAILS / Dettagli tecnici

Item T TS_BI

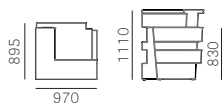

mc 1,00



40 kg

Item T TS_LUCE / T TS_LED

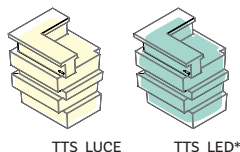

*LED RGB

With LED that changes colours: red, yellow, green, violet, blue, light blue.
Wireless controller included.
Con LED che cambiano colore: rosso, giallo, verde, viola, blu, azzurro.
Controllo wireless in dotazione

PET colours Colori PET



BI

EXAMPLES OF COMBINATIONS upper top (TTS_SUP) / ESEMPI DI CONFIGURAZIONI ripiano superiore (TTS_SUP)

TTS (1 pc/pz)

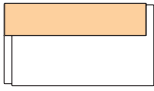

TTS (2 pcs/pz)

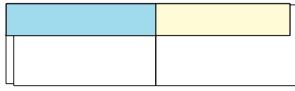

TTS (3 pcs/pz)

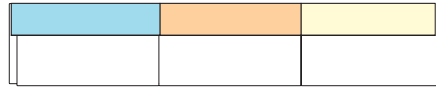

TTS (4 pcs/pz)

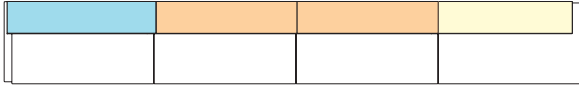

TTS (1 pc/pz), TTSA (1 pc/pz)

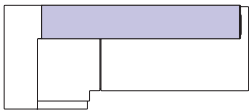

TTS (2 pcs/pz), TTSA (1 pc/pz)

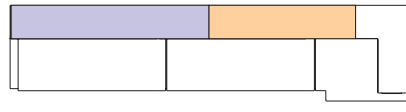

TTS (2 pcs/pz), TTSA (1 pc/pz)

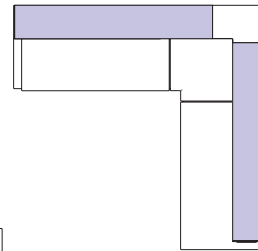

TTS (3 pcs/pz), TTSA (2 pcs/pz)

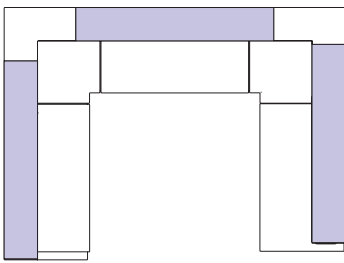

TTS (3 pcs/pz), TTSA (2 pcs/pz)

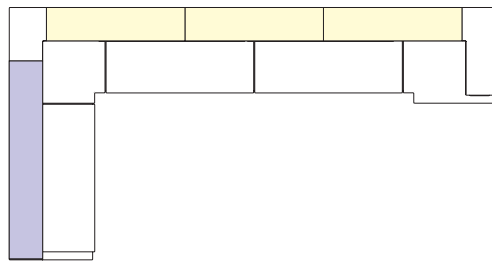

TTS (3 pcs/pz), TTSA (1 pc/pz)

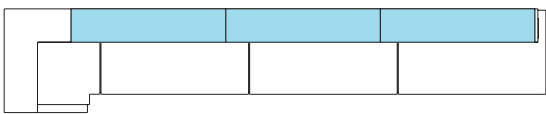

TTS (3 pcs/pz), TTSA (2 pcs/pz)

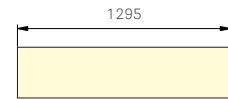
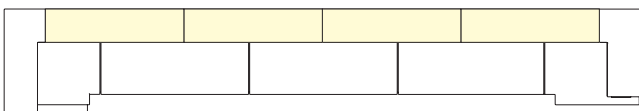

TTS_SUP_130



TTS_SUP_140



TTS_SUP_150



TTS_SUP_185

In case of orders for more than 2 pieces for Tetris bar counter (TTS_BI) with upper top (TTS_SUP), we kindly ask you to confirm us if they are combined together, in order to supply you the correct tops' length.

Per ordini superiori ai 2 pezzi di bancone Tetris (TTS_BI) con ripiano superiore (TTS_SUP) preghiamo di specificare eventuale accostamento in modo da fornire il ripiano nella misura corretta.

COLETTE - COLETTE 50



COLETTE

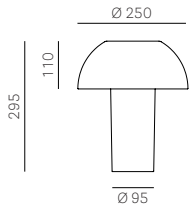

L003TA/BI

FBT 1x12W E14 220-240V
CE IP 20

€ 89,00

VAT not included
22%
€ 72,80



English plug version: upcharge € 48,00 (€ 39,00 vat not included)
Versione con presa britannica: supplemento € 48,00 (€ 39,00 iva esclusa)



BI
White
Bianco



RT
Transparent
red
Rosso
trasparente



FU
Smoky grey
Fumé



TR
Clear
transparent
Trasparente



BT
Transparent
blue
Blu
trasparente



GT
Transparent
yellow
Giallo
trasparente



COLETTE 50

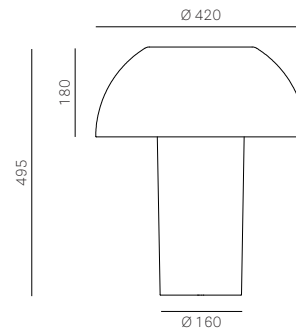

L003TB/BI

FBT 1x24W E27 220-240V
CE IP 20

€ 174,50

VAT not included
22%
€ 143,00



English plug version: upcharge € 48,00 (€ 39,00 vat not included)
Versione con presa britannica: supplemento € 48,00 (€ 39,00 iva esclusa)



BI
White
Bianco



RT
Transparent
red
Rosso
trasparente



FU
Smoky grey
Fumé



TR
Clear
transparent
Trasparente

The device is provided with bulb of energy class: A+ / Il dispositivo è venduto con una lampadina di classe energetica: A+

Price includes light bulb / La lampadina è compresa nel prezzo

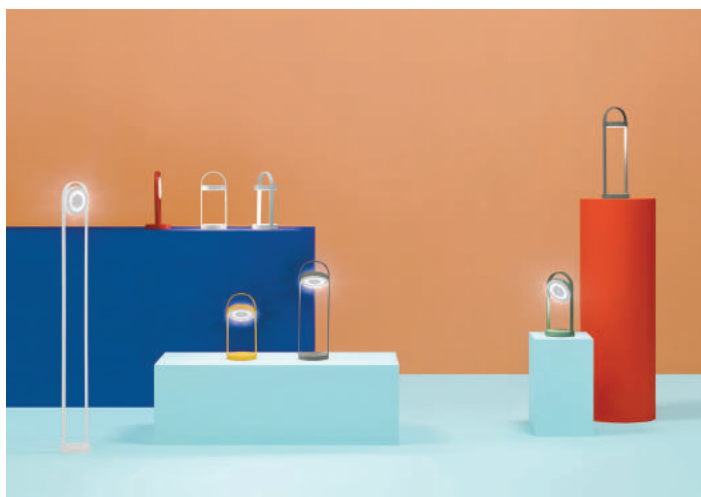

1799
LED 2W 500mA 3000K 5V
CE IP 65 
€ 222,50
VAT not included
22%
€ 182,00

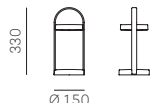

1799/50
LED 2W 500mA 3000K 5V
CE IP 65 
€ 254,00
VAT not included
22%
€ 208,00

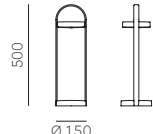

1799/130
LED 2W 500mA 3000K 5V
CE IP 65 
€ 381,00
VAT not included
22%
€ 312,00

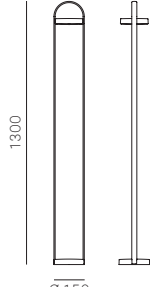

1799_MGN_10
Magnet kit (10 pcs) **€ 159,00** (€ 130,00 vat not included)
Kit magnete (10 pz) **€ 159,00** (€ 130,00 iva esclusa)
Suitable for items 1799 and 1799/50
Valido per art. 1799 e 1799/50



PACKAGING / Imballo



The packaging includes one micro USB cable and one battery charger with Europlug type C.

L'imballo include un cavo di ricarica micro USB e un carica-batterie con spina europea tipo C.

COLOURS / Colori



BATTERY / Batteria

Lithium battery (Li-Po): over 8 hours operating time.
Batteria al litio (Li-Po): durata per oltre 8 ore.



FLOOR/HANGING LAMP / Lampada da terra/a sospensione

330E

FBT 1x15W E27 220-240V

CE IP 65

€ 178,00

VAT not included

22%

€ 145,60



MC 0,12

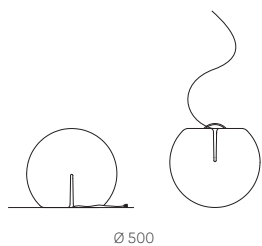

Ø 500

Preparation for hanging, to be done by the customer
Predisposizione per l'appensione a cura del cliente

331E

FBT 1x23W E27 220-240V

CE IP 65

€ 292,00

VAT not included

22%

€ 239,20



MC 0,47

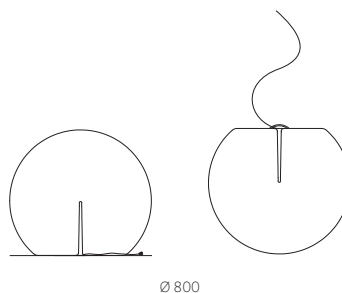

Ø 800

Preparation for hanging, to be done by the customer
Predisposizione per l'appensione a cura del cliente

FLOOR LAMP / Lampada da terra

332E

FBT 1x32W E27 220-240V

CE IP 65

€ 501,50

VAT not included

22%

€ 410,80



MC 1,56

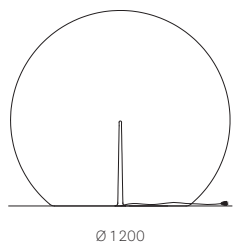

Ø 1200

HAPPY_APPLE_FIX

Floor fixing kit: upcharge **€ 78,00** (€ 63,70 vat not included)

Kit per il fissaggio a terra: supplemento **€ 78,00** (€ 63,70 iva esclusa)

CABLE COLOUR

Colore cavo



VE
Green
Verde

CAP AND HANDLE COLOUR

Colore tappo e maniglia



VE
Green
Verde

POLYETHYLENE FINISH

Finitura polietilene



BI
White
Bianco

The device is provided with bulb of energy class: A+ / Il dispositivo è venduto con una lampadina di classe energetica: A+

Price includes light bulb / La lampadina è compresa nel prezzo

HAPPY APPLE



HANGING LAMP / Lampada a sospensione

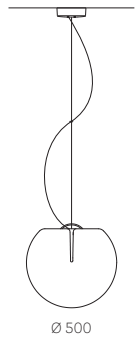

330S
 FBT 1x15W E27 220-240V
 € IP 20 
€ 254,00
 VAT not included
 22%
 € 208,00

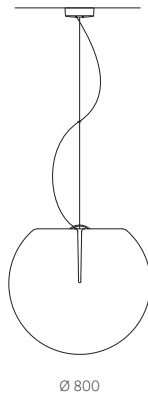

331S
 FBT 1x23W E27 220-240V
 € IP 20 
€ 368,00
 VAT not included
 22%
 € 301,60



WALL/CEILING LAMP / Lampada a muro/soffitto

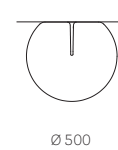

330A
 FBT 1x15W E27 220-240V
 € IP 20 
€ 255,50
 VAT not included
 22%
 € 209,30



FLOOR LAMP / Lampada da terra

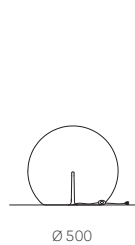

330
 FBT 1x15W E27 220-240V
 € IP 20 
€ 178,00
 VAT not included
 22%
 € 145,60

330_UK
 English plug version
 Versione con presa britannica
 VAT not included
 22%
€ 225,50
 € 184,60

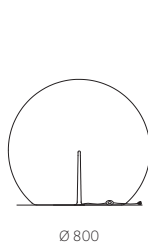

331
 FBT 1x23W E27 220-240V
 € IP 20 
€ 292,00
 VAT not included
 22%
 € 239,20

331_UK
 English plug version
 Versione con presa britannica
 VAT not included
 22%
€ 339,50
 € 278,20

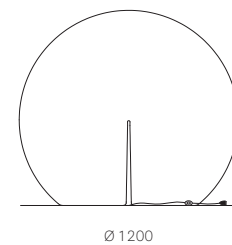

332
 FBT 1x32W E27 220-240V
 € IP 20 
€ 501,50
 VAT not included
 22%
 € 410,80

332_UK
 English plug version
 Versione con presa britannica
 VAT not included
 22%
€ 549,00
 € 449,80



FITTING COLOUR
 Colore rosone



RB
 White
 Bianco

CABLE COLOUR
 Colore cavo



TR
 Transparent
 Trasparente

CAP AND HANDLE COLOUR
 Colore tappo e maniglia



BI
 White
 Bianco

POLYETHYLENE FINISH
 Finitura polietilene



BI
 White
 Bianco

The device is provided with bulb of energy class: A+ / Il dispositivo è venduto con una lampadina di classe energetica: A+

Price includes light bulb / La lampadina è compresa nel prezzo

L001S



*Inner diffuser = colour BI only
Diffusore interno = solo colore BI

DIFFUSER COLOURS / Colori diffusore

Transparent

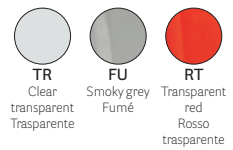

Full colour



Minimum order quantity: 4 hanging lamps / Ordine minimo: 4 lampade a sospensione

The device is compatible with bulbs of the following energy classes: from E to A++ / Questo dispositivo è compatibile con lampadine di classi energetiche: da E a A++

Price doesn't include light bulb / La lampadina non è compresa nel prezzo

L001S

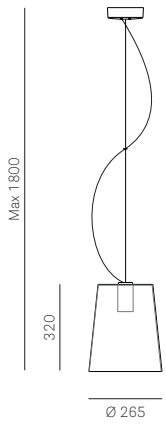

L001S/A

MAX 1x75W E27 220-240V

CE IP 20

€ 103,50

VAT not included
22%

€ 84,50



Cable length > 4m: upcharge € 32,00
(€ 26,00 vat not included)
Lunghezza cavo > 4m: supplemento € 32,00
(€ 26,00 iva esclusa)

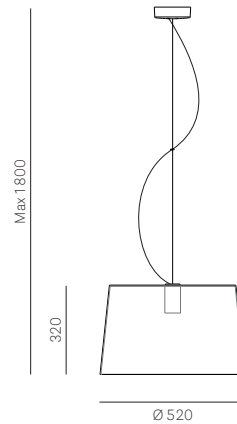

L001S/B

MAX 1x75W E27 220-240V

CE IP 20

€ 159,00

VAT not included
22%

€ 130,00



Cable length > 4m: upcharge € 32,00
(€ 26,00 vat not included)
Lunghezza cavo > 4m: supplemento € 32,00
(€ 26,00 iva esclusa)

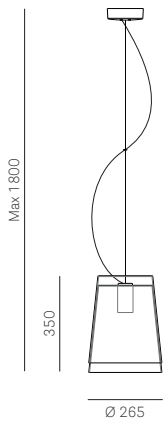

L001S/AA

MAX 1x75W E27 220-240V

CE IP 20

€ 159,00

VAT not included
22%

€ 130,00



Cable length > 4m: upcharge € 32,00
(€ 26,00 vat not included)
Lunghezza cavo > 4m: supplemento € 32,00
(€ 26,00 iva esclusa)

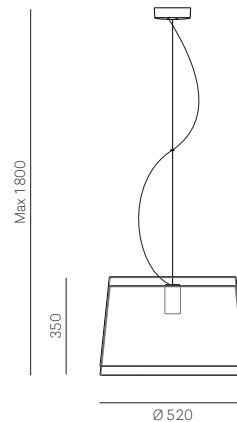

L001S/BB

MAX 1x75W E27 220-240V

CE IP 20

€ 270,00

VAT not included
22%

€ 221,00



Cable length > 4m: upcharge € 32,00
(€ 26,00 vat not included)
Lunghezza cavo > 4m: supplemento € 32,00
(€ 26,00 iva esclusa)

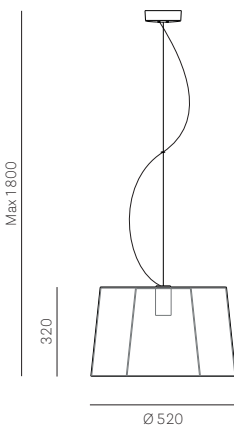

L001S/BA

MAX 1x75W E27 220-240V

CE IP 20

€ 214,50

VAT not included
22%

€ 175,50



Cable length > 4m: upcharge € 32,00
(€ 26,00 vat not included)
Lunghezza cavo > 4m: supplemento € 32,00
(€ 26,00 iva esclusa)

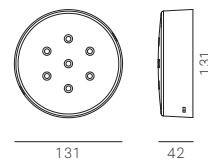

FITTING COLOUR / Colore rosone



Black colour fitting version (item RN): upcharge € 8,00 (€ 6,50 vat not included)
Versione con rosone colore nero (art. RN): supplemento € 8,00 (€ 6,50 iva esclusa)

Minimum order quantity: 4 hanging lamps / Ordine minimo: 4 lampade a sospensione

The device is compatible with bulbs of the following energy classes: from E to A++ / Questo dispositivo è compatibile con lampadine di classi energetiche: da E a A++

Price doesn't include light bulb / La lampadina non è compresa nel prezzo

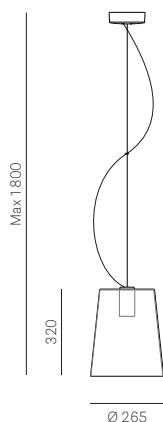

L001S/A

MAX 1x75W E27 220-240V

CE IP 20

€ 159,00

VAT not included
22%

€ 130,00



Cable length > 4m: upcharge **€ 32,00** (€ 26,00 vat not included)
Lunghezza cavo > 4m: supplemento **€ 32,00** (€ 26,00 iva esclusa)

DIFFUSER COLOURS / Colori diffusore

Soft-touch powder coating
Verniciato finitura soft-touch

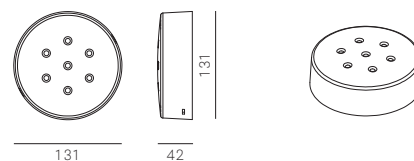
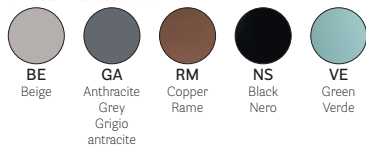

FITTING COLOUR / Colore rosone



Black colour fitting version (item RN): upcharge **€ 8,00** (€ 6,50 vat not included)
Versione con rosone colore nero (art. RN): supplemento **€ 8,00** (€ 6,50 iva esclusa)

Minimum order quantity: 4 hanging lamps / Ordine minimo: 4 lampade a sospensione

The device is compatible with bulbs of the following energy classes: from E to A++ / Questo dispositivo è compatibile con lampadine di classi energetiche: da E a A++

Price doesn't include light bulb / La lampadina non è compresa nel prezzo

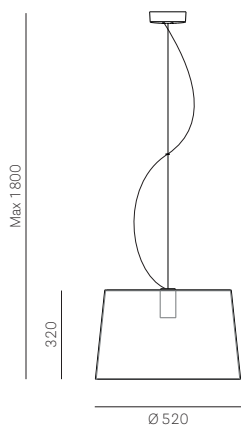

L001S/B

MAX 1x75W E27 220-240V

CE IP 20

€ 238,00

VAT not included
22%

€ 195,00



Cable length > 4m: upcharge **€ 32,00**

(€ 26,00 vat not included)

Lunghezza cavo > 4m: supplemento **€ 32,00**

(€ 26,00 iva esclusa)

DIFFUSER COLOURS / Colori diffusore

Soft-touch powder coating

Verniciato finitura soft-touch

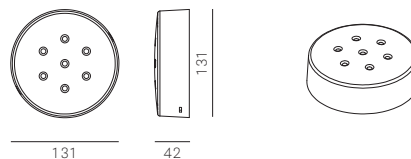
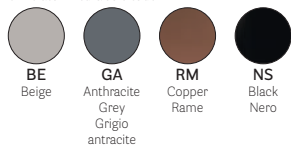

FITTING COLOUR / Colore rosone



Black colour fitting version (item RN): upcharge **€ 8,00** (€ 6,50 vat not included)
Versione con rosone colore nero (art. RN): supplemento **€ 8,00** (€ 6,50 iva esclusa)

Minimum order quantity: 4 hanging lamps / Ordine minimo: 4 lampade a sospensione

The device is compatible with bulbs of the following energy classes: from E to A++ / Questo dispositivo è compatibile con lampadine di classi energetiche: da E a A++

Price doesn't include light bulb / La lampadina non è compresa nel prezzo

L001SW

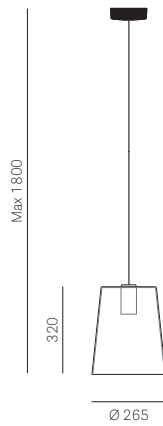

L001SW/A

MAX 1x23W E27 220-240V

CE IP 20

€ 119,00 (TR, FU, RT, VL)

€ 174,50 (BE, GA, RM, NS, VE)

VAT not included
22%

€ 97,50 (TR, FU, RT, VL)

€ 143,00 (BE, GA, RM, NS, VE)



Cable length 1,5 m
Lunghezza cavo 1,5 m

DIFFUSER COLOURS / Colori diffusore

Transparent

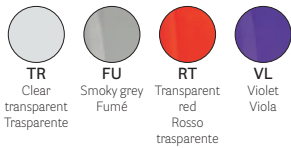

Soft-touch powder coating
Verniciato finitura soft-touch

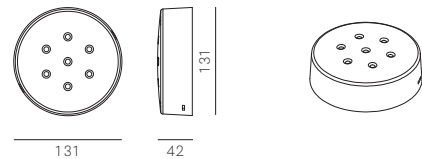
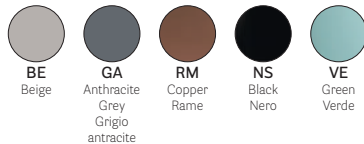

FITTING AND CABLE COLOUR / Colore rosone e cavo



Minimum order quantity: 4 hanging lamps / Ordine minimo: 4 lampade a sospensione

The device is compatible with bulbs of the following energy classes: from B to A++ / Questo dispositivo è compatibile con lampadine di classi energetiche: da B a A++

Price doesn't include light bulb / La lampadina non è compresa nel prezzo

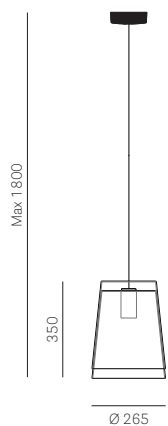

L001SW/AA

MAX 1x23W E27 220-240V

€ IP 20

€ 174,50 (TR, FU, RT)

VAT not included
22%

€ 143,00 (TR, FU, RT)



Cable length 1,5 m
Lunghezza cavo 1,5 m

DIFFUSER COLOURS / Colori diffusore

Transparent



TR
Clear
transparent
Trasparente



FU
Smoky grey
Fumé



RT
Transparent
red
Rosso
trasparente

Full colour



BI*
White
Bianco

***For inner diffuser A**
Solo per diffusore interno A

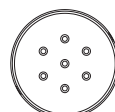

131

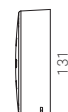

42

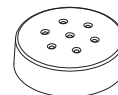

FITTING AND CABLE COLOUR / Colore rosone e cavo



Matt black
Nero opaco

Minimum order quantity: 4 hanging lamps / Ordine minimo: 4 lampade a sospensione

The device is compatible with bulbs of the following energy classes: from B to A++ / Questo dispositivo è compatibile con lampadine di classi energetiche: da B a A++

Price doesn't include light bulb / La lampadina non è compresa nel prezzo

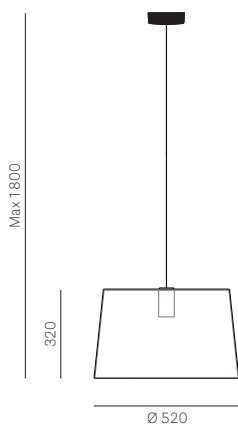
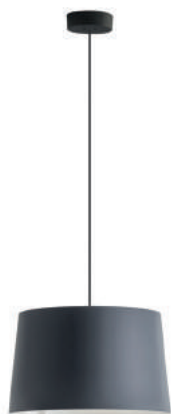

L001SW/B

MAX 1x23W E27 220-240V

CE IP 20

€ 174,50 (TR, FU, RT)

€ 254,00 (BE, GA, RM, NS)

VAT not included
22%

€ 143,00 (TR, FU, RT)

€ 208,00 (BE, GA, RM, NS)



Cable length 1,5 m
Lunghezza cavo 1,5 m

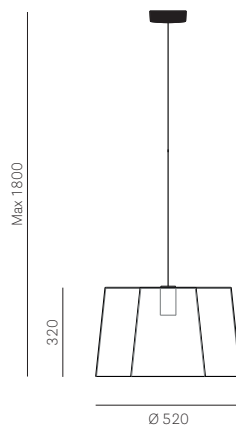

L001SW/BA

MAX 1x23W E27 220-240V

CE IP 20

€ 230,00 (TR, FU)

VAT not included
22%

€ 188,50 (TR, FU)



Cable length 1,5 m
Lunghezza cavo 1,5 m

DIFFUSER COLOURS / Colori diffusore

Transparent



TR
Clear
transparent
Trasparente



FU
Smoky grey
Fumé



RT
Transparent
red
Rosso
trasparente

Full colour



BI*
White
Bianco

*For diffuser A
Solo per diffusore A

Soft-touch powder coating
Verniciato finitura soft-touch



BE
Beige



GA
Anthracite
Grey
Grigio
antracite



RM
Copper
Rame



NS
Black
Nero

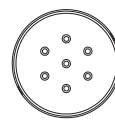

131



42

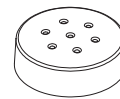

FITTING AND CABLE COLOUR / Colore rosone e cavo



Matt black
Nero opaco

Minimum order quantity: 4 hanging lamps / Ordine minimo: 4 lampade a sospensione

The device is compatible with bulbs of the following energy classes: from B to A++ / Questo dispositivo è compatibile con lampadine di classi energetiche: da B a A++

Price doesn't include light bulb / La lampadina non è compresa nel prezzo

L001TA

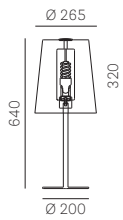

L001TA/A

FBT 1x23W E27 220-240V

CE IP 20

€ 284,00

VAT not included
22%
€ 232,70

L001TA/A_UK

English plug version
Versione con presa britannica

€ 331,50

VAT not included
22%
€ 271,70

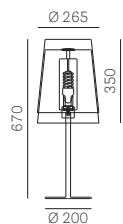

L001TA/AA

FBT 1x23W E27 220-240V

CE IP 20

€ 324,00

VAT not included
22%
€ 265,20

L001TA/AA_UK

English plug version
Versione con presa britannica

€ 371,50

VAT not included
22%
€ 304,20



L001TA/A

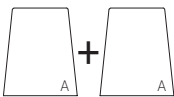

L001TA/AA*

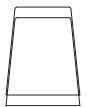

*Inner diffuser = colour BI only
Diffusore interno = solo colore BI

DIFFUSER COLOURS / Colori diffusore

Transparent



Full colour



BASE COLOURS / Colori base



The device is provided with bulb of energy class: A+ / Il dispositivo è venduto con una lampadina di classe energetica: A+

Price includes light bulb / La lampadina è compresa nel prezzo

L001T

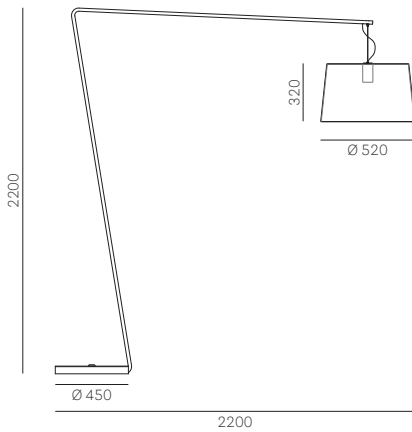

L001T/B
MAX 1x100W E27 220-240V
CE IP 20

€ 942,50

VAT not included
22%
€ 772,20

L001T/B_UK
English plug version
Versione con presa britannica

€ 990,00

VAT not included
22%
€ 811,20

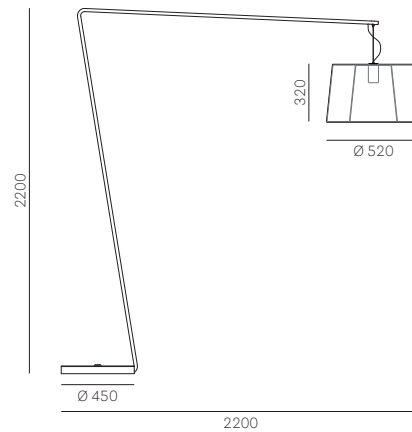

L001T/BA
MAX 1x100W E27 220-240V
CE IP 20

€ 998,00

VAT not included
22%
€ 817,70

L001T/BA_UK
English plug version
Versione con presa britannica

€ 1.045,50

VAT not included
22%
€ 856,70



L001T/B

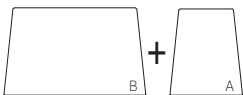

L001T/BA*

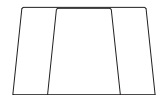

*Inner diffuser = colour BI only
Diffusore interno = solo colore BI

DIFFUSER COLOURS / Colori diffusore

Transparent

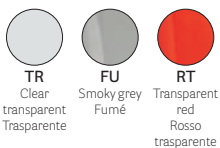

Full colour



BASE COLOURS / Colori base



The device is compatible with bulbs of the following energy classes: from E to A++ / Questo dispositivo è compatibile con lampadine di classi energetiche: da E a A++

Price doesn't include light bulb / La lampadina non è compresa nel prezzo

L001ST

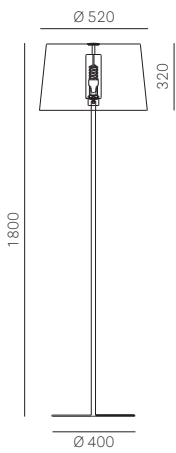

L001ST/B
 FBT 1x23W E27 220-240V
 CE IP 20

€ 557,00 (BE)

VAT not included
 22%
 € 456,30

L001ST/B_UK

English plug version
 Versione con presa britannica

€ 604,50 (BE)

VAT not included
 22%
 € 495,30

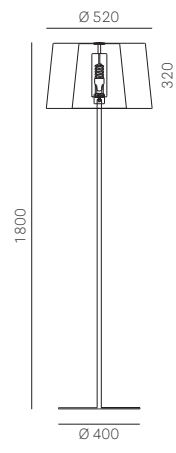

L001ST/BA
 FBT 1x23W E27 220-240V
 CE IP 20

€ 446,00 (TR, FU)

VAT not included
 22%
 € 365,30

L001ST/BA_UK

English plug version
 Versione con presa britannica

€ 493,50 (TR, FU)

VAT not included
 22%
 € 404,30



Surcharge for antique brass frame: € 159,00 (€ 130,00 vat not included)
 Supplemento struttura ottone anticato: € 159,00 (€ 130,00 iva esclusa)

Surcharge for antique brass frame: € 159,00 (€ 130,00 vat not included)
 Supplemento struttura ottone anticato: € 159,00 (€ 130,00 iva esclusa)



L001ST/B

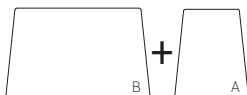

L001ST/BA*

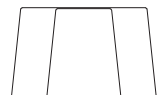

*Inner diffuser = colour BI only
 Diffusore interno = solo colore BI

DIFFUSER COLOURS / Colori diffusore

Transparent



Full colour



*For diffuser A
 Solo per diffusore A

Soft-touch powder coating
 Verniciato finitura soft-touch



BASE COLOURS / Colori base



The device is provided with bulb of energy class: A+ / Il dispositivo è venduto con una lampadina di classe energetica A+

Price includes light bulb / La lampadina è compresa nel prezzo

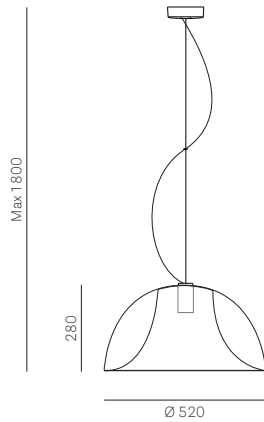

L002S/BA

MAX 1x75W E27 220-240V

CE IP 20

€ 222,50

VAT not included
22%

€ 182,00



Cable length > 4m: upcharge **€ 32,00** (€ 26,00 vat not included)
Lunghezza cavo > 4m: supplemento **€ 32,00** (€ 26,00 iva esclusa)



*Inner diffuser = colour BI only
Diffusore interno = solo colore BI

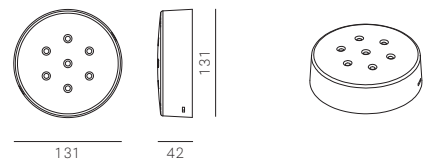

FITTING COLOUR / Colore rosone



DIFFUSER B COLOURS / Colori diffusore B

Transparent



TR
Clear
transparent
Trasparente



GT
Transparent
yellow
Giallo
trasparente



RT
Transparent
red
Rosso
trasparente

Full colour



NE
Black
Nero



BI
White
Bianco

Black colour fitting version (item RN): upcharge **€ 8,00** (€ 6,50 vat not included)
Versione con rosone colore nero (art. RN): supplemento **€ 8,00** (€ 6,50 iva esclusa)

Minimum order quantity: 4 hanging lamps / Ordine minimo: 4 lampade a sospensione

The device is compatible with bulbs of the following energy classes: from E to A++ / Questo dispositivo è compatibile con lampadine di classi energetiche: da E a A++

Price doesn't include light bulb / La lampadina non è compresa nel prezzo

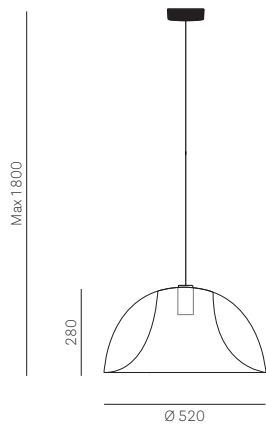
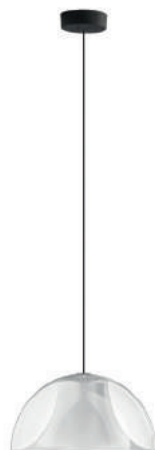

L002SW/BA

MAX 1x23W E27 220-240V

€ IP 20

€ 238,00 (TR)

€ 376,00 (GA)

VAT not included
22%

€ 195,00 (TR)

€ 308,10 (GA)



Cable length 1,5 m
Lunghezza cavo 1,5 m

DIFFUSER COLOURS / Colori diffusore

Transparent



TR
Clear
transparent
Trasparente

Full colour



BI*
White
Bianco

*For diffuser A
Solo per diffusore A

Soft-touch powder coating
Verniciato finitura soft-touch



GA
Anthracite
Grey
Grigio
antracite

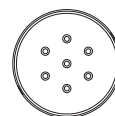

131

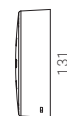

42

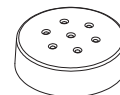

FITTING AND CABLE COLOUR / Colore rosone e cavo



Matt black
Nero opaco

Minimum order quantity: 4 hanging lamps / Ordine minimo: 4 lampade a sospensione

The device is compatible with bulbs of the following energy classes: from B to A++ / Questo dispositivo è compatibile con lampadine di classi energetiche: da B a A++

Price doesn't include light bulb / La lampadina non è compresa nel prezzo

L002T - L002ST

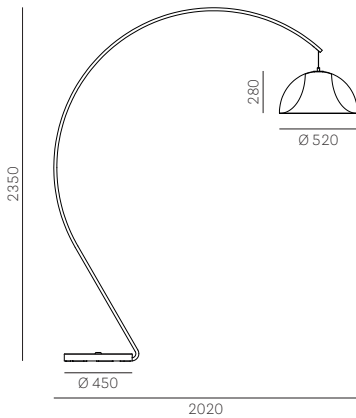

L002T/BA

MAX 1x100W E27 220-240V

€ IP 20

VAT not included
22%
€ 950,50 € 778,70

L002T/BA_UK

English plug version
Versione con presa britannica

VAT not included
22%
€ 998,00 € 817,70

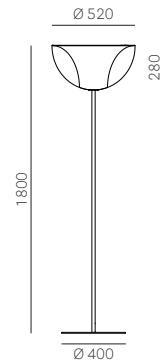

L002ST/BA

FBT 1x23W E27 220-240V

€ IP 20

VAT not included
22%
€ 446,00 € 365,30

L002ST/BA_UK

English plug version
Versione con presa britannica

VAT not included
22%
€ 493,50 € 404,30



Surcharge for antique brass frame: € 159,00 (€ 130,00 vat not included)
Supplemento struttura ottone anticato: € 159,00 (€ 130,00 iva esclusa)

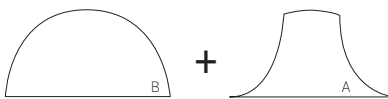

L002T/BA*
L002ST/BA*

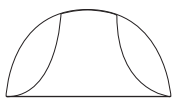

*Inner diffuser = colour BI only
Diffusore interno = solo colore BI

L002T/BA
DIFFUSER B COLOURS / Colori diffusore B

Transparent

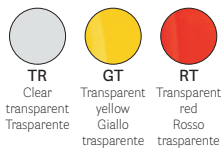

Full colour



BASE COLOURS / Colori base



L002ST/BA
DIFFUSER B COLOURS / Colori diffusore B

Full colour



BASE COLOURS / Colori base



* White diffuser combined with white or antique brass base
Black diffuser combined with black or antique brass base
Diffusore bianco abbinato alla base bianca oppure ottone anticato
Diffusore nero abbinato alla base nera oppure ottone anticato

The device is compatible with bulbs of the following energy classes: from E to A++
Questo dispositivo è compatibile con lampadine di classi energetiche: da E a A++

Price doesn't include light bulb / La lampadina non è compresa nel prezzo

The device is provided with bulb of energy class: A+
Il dispositivo è venduto con una lampadina di classe energetica: A+

Price includes light bulb / La lampadina è compresa nel prezzo

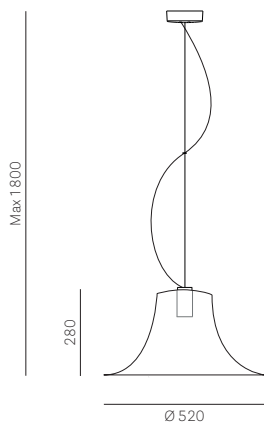

L004S/A

MAX 1x75W E27 220-240V

CE IP 20

€ 252,50

VAT not included
22%

€ 206,70



Cable length > 4m: upcharge **€ 32,00** (€ 26,00 vat not included)
Lunghezza cavo > 4m: supplemento **€ 32,00** (€ 26,00 iva esclusa)

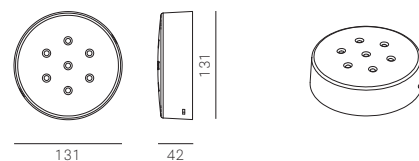

FITTING COLOUR / Colore rosone



RB
White
Bianco

Black colour fitting version (item RN): upcharge **€ 8,00** (€ 6,50 vat not included)
Versione con rosone colore nero (art. RN): supplemento **€ 8,00** (€ 6,50 iva esclusa)

DIFFUSER COLOURS / Colori diffusore

Soft-touch powder coating
Verniciato finitura soft-touch



BE

Beige

GA

Anthracite

Grey

Grigio

antracite

RM

Copper

Rame

NS

Black

Nero

VE

Green

Verde

Minimum order quantity: 4 hanging lamps / Ordine minimo: 4 lampade a sospensione

The device is compatible with bulbs of the following energy classes: from E to A++ / Questo dispositivo è compatibile con lampadine di classi energetiche: da E a A++

Price doesn't include light bulb / La lampadina non è compresa nel prezzo

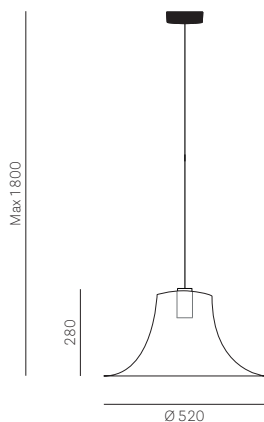
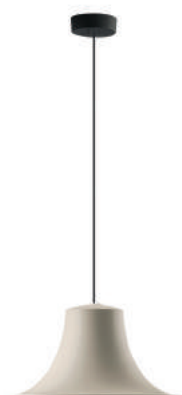

L004SW/A

MAX 1x23W E27 220-240V

CE IP 20

€ 268,50

VAT not included
22%

€ 219,70



MC0,10

Cable length 1,5 m
Lunghezza cavo 1,5 m

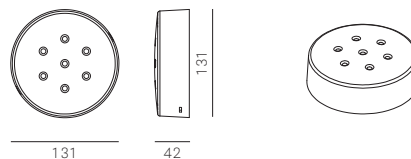

DIFFUSER COLOURS / Colori diffusore

Soft-touch powder coating
Verniciato finitura soft-touch

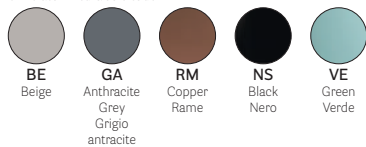

FITTING AND CABLE COLOUR / Colore rosone e cavo



Matt black
Nero opaco

Minimum order quantity: 4 hanging lamps / Ordine minimo: 4 lampade a sospensione

The device is compatible with bulbs of the following energy classes: from B to A++ / Questo dispositivo è compatibile con lampadine di classi energetiche: da B a A++

Price doesn't include light bulb / La lampadina non è compresa nel prezzo

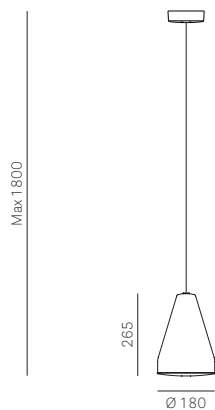

L005S/A

LED 13W 120mA 3000K 220-240V

€ IP 20

€ 254,00

€ 287,50 (OS, RM2)

VAT not included
22%

€ 208,00

€ 235,30 (OS, RM2)



Cable length 1,5 m
Lunghezza cavo 1,5 m

DIFFUSER COLOURS / Colori diffusore

Soft-touch powder coating
Verniciato finitura soft-touch



FITTING AND CABLE COLOUR / Colore rosone e cavo



Minimum order quantity: 4 hanging lamps / Ordine minimo: 4 lampade a sospensione

The device provided with bulb of energy class: A+ / Il dispositivo è venduto con una lampadina di classe energetica A+

Price includes light bulb / La lampadina è compresa nel prezzo

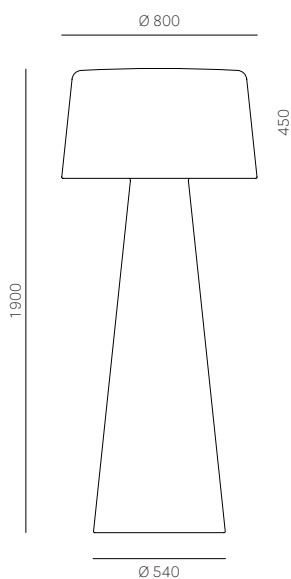

T_OUT/BI_LUCE

230V MAX 2X27W

CE IP 44

€ 1.039,00

VAT not included
22%

€ 851,50



T_OUT_FIX

Floor fixing kit: upcharge **€ 119,00** (€ 97,50 vat not included)

Kit per il fissaggio a terra: supplemento **€ 119,00** (€ 97,50 iva esclusa)

COLOUR / Colore



BI

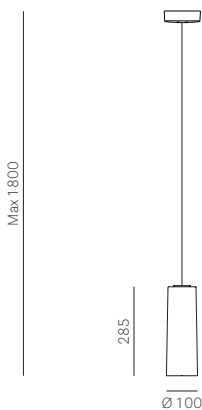

L006S/A
MAX 1x23W E27 220-240V
CE IP 20

€ 155,50

VAT not included
22%

€ 127,40



Cable length 1,5 m
Lunghezza cavo 1,5 m

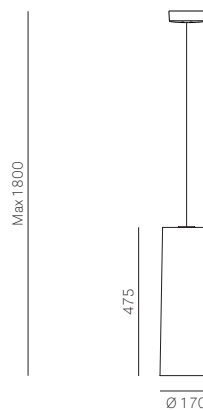

L006SW/B
MAX 1x23W E27 220-240V
CE IP 20

€ 205,00

VAT not included
22%

€ 167,70



Cable length 1,5 m
Lunghezza cavo 1,5 m

DIFFUSER COLOURS / Colori diffusore

Soft-touch powder coating
Verniciato finitura soft-touch



NS
Black
Nero

Powder coating
Verniciato



EC
Corten



OR2
Pink brass
Ottone rosa

FITTING AND CABLE COLOUR / Colore rosone e cavo



Matt black
Nero
opaco



*** Matt white**
Bianco
opaco

*** L006S/A only**
Solo L006S/A

Minimum order quantity: 4 hanging lamps / Ordine minimo: 4 lampade a sospensione

The device is compatible with bulbs of the following energy classes: from B to A++ / Questo dispositivo è compatibile con lampadine di classi energetiche: da B a A++

Price doesn't include light bulb / La lampadina non è compresa nel prezzo

Finishes / Finiture

Steel and stainless steel / Acciaio e acciaio inox



CR
Chromed steel
Acciaio cromato



ST
Satinized steel
Acciaio satinato

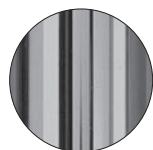

CN
Black chromed steel
Acciaio cromato nero



LU
Polished s/steel
Acciaio inox lucidato

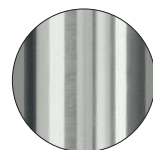

AC
Brushed s/steel
Acciaio inox satinato

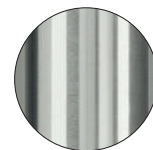

AC 316
Brushed s/steel AISI 316
for outdoor
Acciaio inox AISI 316 per
esterno

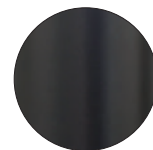

TN
Titanium steel
Acciaio finitura titanio



BS
Brushed bronze
Bronzo satinato



OA
Antique brass steel
Acciaio ottone anticato

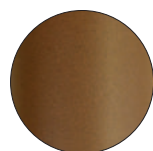

EC
Corten steel
Acciaio effetto Corten

Aluminium / Alluminio



LU
Polished aluminium
Alluminio lucidato



AS
Satinized aluminium
Alluminio satinato

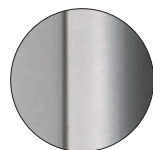

AA
Anodized aluminium
Alluminio anodizzato



TN
Titanium
Titanio

Indoor finishes / Finiture per interno

Powder coated cast-iron, steel and aluminium / Ghisa, acciaio e alluminio verniciato

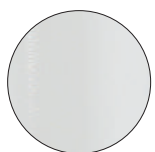

BI100
White,
textured-matt finish
Bianco,
finitura goffrata-opaca



BI200
White,
textured-matt finish
Bianco,
finitura goffrata-opaca

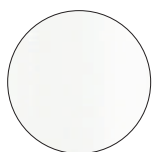

BI300
White,
smooth-matt finish
Bianco,
finitura liscia-opaca

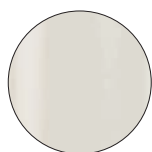

BI400
White,
smooth-glossy finish
Bianco,
finitura liscia-lucida

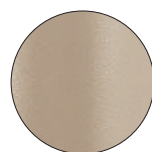

SA200
Sand,
textured-matt finish
Sabbia,
finitura goffrata-opaca

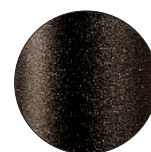

MG
Brown,
textured-matt finish
Marrone,
finitura goffrata-opaca

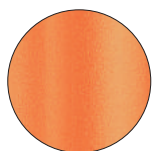

AR200
Orange,
textured-matt finish
Arancio,
finitura goffrata-opaca

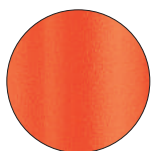

AR400
Orange,
textured-matt finish
Arancio,
finitura goffrata-opaca

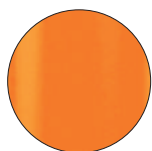

AR300
Orange,
smooth-glossy finish
Arancio,
finitura liscia-lucida

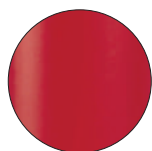

RO200
Red,
textured-matt finish
Rosso,
finitura goffrata-opaca

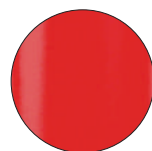

RO100
Red,
smooth-glossy finish
Rosso,
finitura liscia-lucida

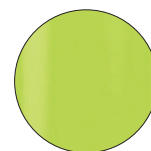

VE200
Green,
smooth-glossy finish
Verde,
finitura liscia-lucida

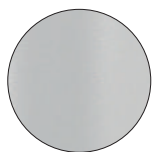

BE100
Beige,
textured-matt finish
Beige,
finitura goffrata-opaca

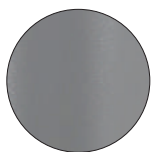

BE200
Beige,
textured-matt finish
Beige,
finitura goffrata-opaca

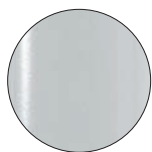

AL
Aluminium,
smooth-glossy finish
Alluminio,
finitura liscia-lucida



GA
Anthracite grey,
textured-matt finish
Grigio antracite,
finitura goffrata-opaca



_NERO
Black,
hammered-matt finish
Nero,
finitura bucciata-opaca



NEF
Black soft-touch,
smooth-matt finish
Nero soft-touch,
finitura liscia-opaca



TR
Transparent powder coated,
smooth-matt finish
Verniciatura trasparente,
finitura liscia-opaca

Colours are indicative. Pedrali reserves the right to modify or upgrade the product without prior notice.
I colori sono indicativi. Pedrali si riserva la facoltà di apportare modifiche o migliorie senza alcun preavviso.

Outdoor finishes / Finiture per esterno



Powder coated cast-iron, steel and aluminium / Ghisa, acciaio e alluminio verniciato

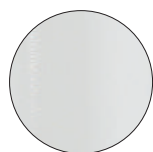

BI100E
White,
textured-matt finish
Bianco,
finitura goffrata-opaca



BI200E
White,
textured-matt finish
Bianco,
finitura goffrata-opaca

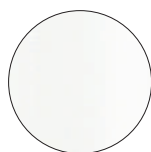

BI300E
White,
smooth-matt finish
Bianco,
finitura liscia-opaca

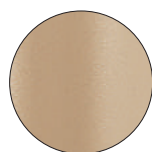

SA100E
Sand,
textured-matt finish
Sabbia,
finitura goffrata-opaca

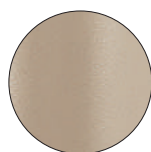

SA200E
Sand,
textured-matt finish
Sabbia,
finitura goffrata-opaca

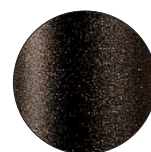

MGE
Brown,
textured-matt finish
Marrone,
finitura goffrata-opaca

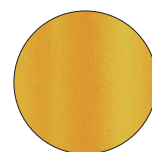

GI100E
Yellow,
textured-matt finish
Giallo,
finitura goffrata-opaca

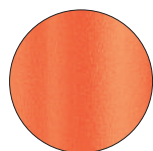

AR500E
Orange,
textured-matt finish
Arancio,
finitura goffrata-opaca

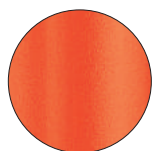

AR400E
Orange,
textured-matt finish
Arancio,
finitura goffrata-opaca

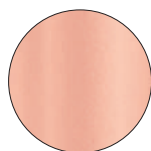

RA100E
Pink,
textured-matt finish
Rosa,
finitura goffrata-opaca

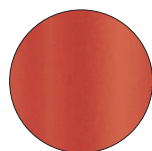

RO400E
Red,
textured-matt finish
Rosso,
finitura goffrata-opaca

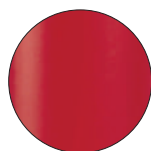

RO200E
Red,
textured-matt finish
Rosso,
finitura goffrata-opaca

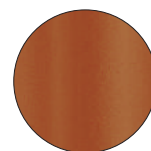

TEE
Terracotta,
textured-matt finish
Terracotta,
finitura goffrata-opaca

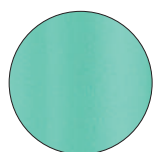

AZ100E
Light blue,
textured-matt finish
Azzurro,
finitura goffrata-opaca

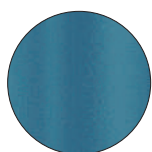

BL300E
Blue,
textured-matt finish
Blu,
finitura goffrata-opaca

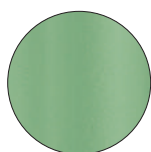

VE100E
Sage green,
textured-matt finish
Verde salvia,
finitura goffrata-opaca



VE300E
Forest green soft-touch,
smooth-matt finish
Verde bosco soft-touch,
finitura liscia-opaca

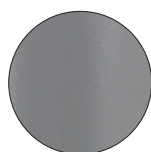

BE200E
Beige,
textured-matt finish
Beige,
finitura goffrata-opaca

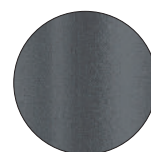

GAE
Anthracite grey,
textured-matt finish
Grigio antracite,
finitura goffrata-opaca



NPE
Black,
textured-matt finish
Nero,
finitura goffrata-opaca

Colours are indicative. Pedrali reserves the right to modify or upgrade the product without prior notice.
I colori sono indicativi. Pedrali si riserva la facoltà di apportare modifiche o migliorie senza alcun preavviso.

Category A

Simil leather / Finta pelle

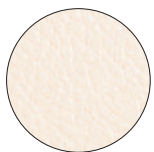

A96



A95

Category B

Nylon / Nylon

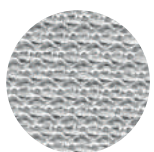

B01

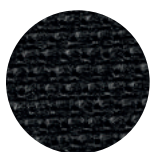

B02

For Island item 795-796-797
Per Island art. 795-796-797

Category C

Fabric / Tessuto



C36



C37

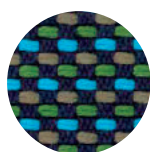

C38



C39

For Noa, Tweet, Wow, Buddy and the following cushions only:
Social Plus, Blitz, Buddy, Pasha, Gliss and Ikon bench.
Solo per Noa, Tweet, Wow, Buddy e per i seguenti cuscini:
Social Plus, Blitz, Buddy, Pasha, Gliss e Ikon bench.

Fire retardant fabric / Tessuto ignifugo

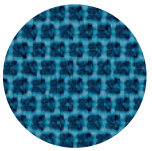

C83

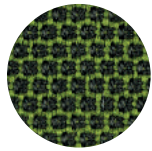

C84

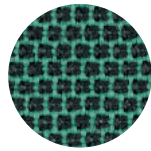

C88

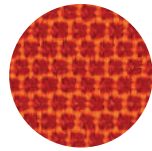

C85

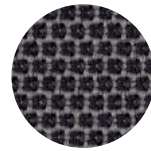

C86

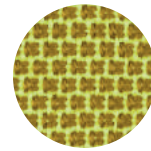

C87

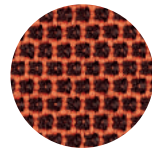

C89

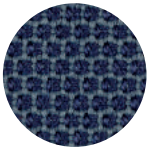

C100

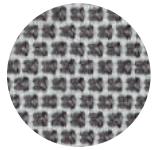

C101



BS EN 1021 1&2
BS EN 1021-1
BS 5852 PART 1 0, 1
US CA TB 117-2013

Fire retardant fabric / Tessuto ignifugo

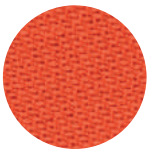

C110

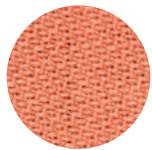

C111

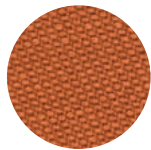

C112

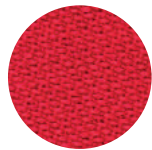

C113

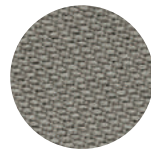

C114

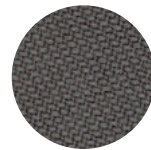

C115

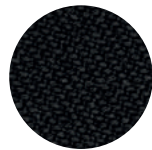

C116

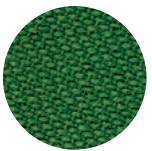

C117

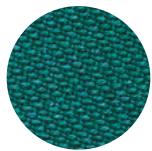

C118

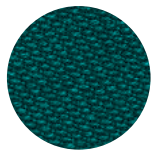

C119

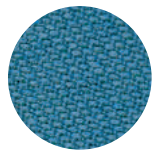

C120

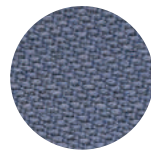

C121

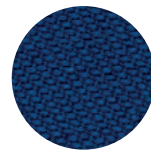

C122



BS 5852 Crib 5
EN ISO 1021 part 1&2
IMO FTP Code 2010: Part 8
UNI 9175 CLASSE 1 IM



Fire retardant simil leather / Finta pelle ignifuga



C14

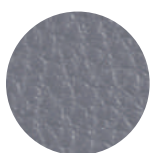

C15



C17

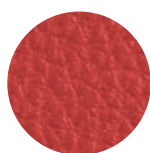

C20



C21



AM 18 (NFD 60 013)
B2 (DIN 4102)
BS 5852 crib 5
Cs3do (EN 13501-1)
CATB 117 E
CATB 133
EN 1021 1-2
FAR 25853 App F Part 1
IMO A652
M1 (NFP 92503)
NY/NJ - Port Authority
UFAC Fabric class 1
German fire standard B1



Fire retardant simil leather / Finta pelle ignifuga



C90



C94



C95

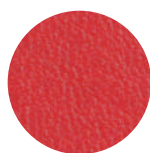

C92



C91



C93



BS 5852-1 PART 1
EN 1021-2
IMO RESOLUTION A.652 (16): 1989
UNI 9175 CLASSE 1 IM
US CA TB 117-2013



Fire retardant simil leather / Finta pelle ignifuga



C130



C131



C132

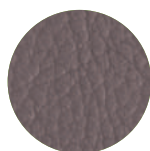

C133



C134

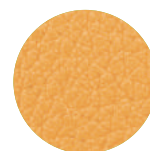

C135

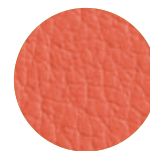

C136

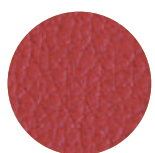

C137



C138



C139



C140



C141



EN 1021 part. 1-2
BS5852-1 match test
UNI 9175 classe 1 IM
US CA TB 117-2013

Colours are indicative. Pedrali reserves the right to modify or upgrade the product without prior notice.
I colori sono indicativi. Pedrali si riserva la facoltà di apportare modifiche o migliorie senza alcun preavviso.

Category D

Fabric / Tessuto

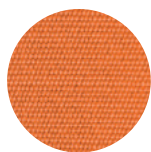

D31

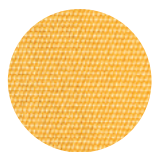

D32

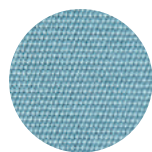

D33



D34

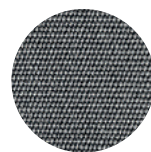

D35

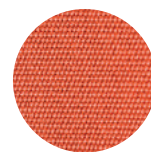

D36

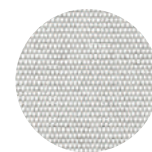

D37

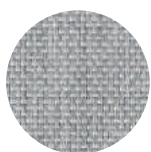

D38



D39

For cushions Intrigo, Nolita, Plus, Plus Air, Reva and Sunset
Per cuscini Intrigo, Nolita, Plus, Plus Air, Reva e Sunset

Fire retardant fabric / Tessuto ignifugo

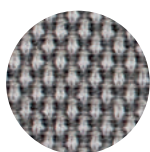

D40

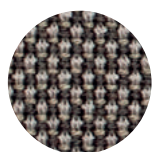

D41

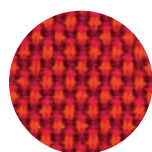

D42

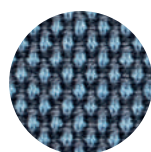

D43

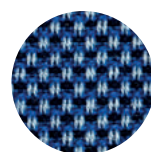

D44



BS EN 1021 1&2
BS 5852 PART 1 0, 1
UNI 9175 CLASSE 1 IM
US CA TB 117-2013

Category E

Velvet / Velluto

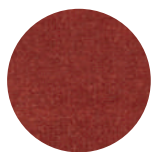

E01



E02

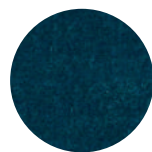

E03

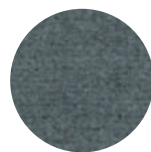

E04

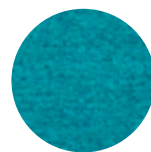

E05

Colours are indicative. Pedrali reserves the right to modify or upgrade the product without prior notice.
I colori sono indicativi. Pedrali si riserva la facoltà di apportare modifiche o migliorie senza alcun preavviso.

Category F

Genuine leather / Cuoio naturale



F05



F01

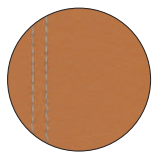

F04

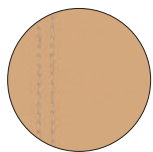

F03

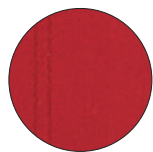

F06



F07

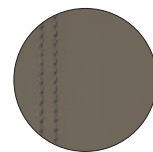

F08



F09

Regenerated leather / Cuoio rigenerato

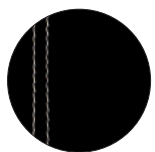

F11



F12

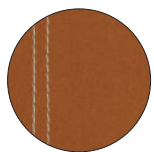

F13

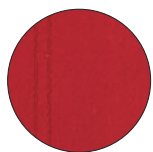

F17

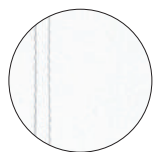

F18

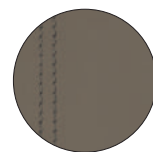

F19

The stitches are in contrast with the leather colour of items code:

341, 351, 361, 497, 904/F, 930, 966/F, 1281, 1291, 1298, 2461, 2462, 2463, 2464, 4427/F

The stitches match with the leather colour of items code:

297, 252, 256, 392, 397, 448, 720, 3727, 3728, 5663, 5669, 5664

Le cuciture sono in contrasto per gli articoli:

341, 351, 361, 497, 904/F, 930, 966/F, 1281, 1291, 1298, 2461, 2462, 2463, 2464, 4427/F

Le cuciture sono in tinta per gli articoli:

297, 252, 256, 392, 397, 448, 720, 3727, 3728, 5663, 5669, 5664

Category G

Fire retardant wool / Lana ignifuga

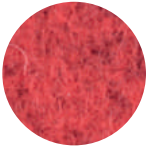

G21

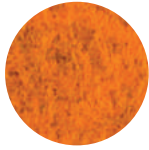

G22



G23

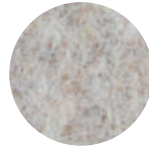

G24

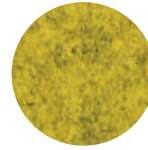

G25



AS/NZS 1530.3
BS 5852 Crib 5
BS 5852 part 1
DIN 4102 B2
EN 1021-1/2
IMO FTP Code 2010 Part 8
NFD 60 013
NFPA 260
ÖNORM B1/ Q1
SN 198 898 5.3 with treatment
UNI 9175 1 IM
US CA TB 117-2013

Fire retardant wool / Lana ignifuga



G110

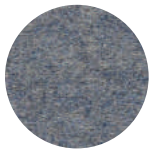

G111



G112

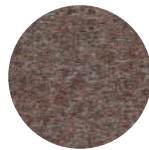

G113



G114

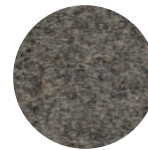

G115



G116



AS/NZS 1530.3
BS 5852 Crib 5
BS 5852 part 1
DIN 4102 B2
EN 1021-1/2
IMO FTP Code 2010 Part 8
NFD 60 013
NFPA 260
ÖNORM B1/ Q1
SN 198 898 5.3 with treatment
UNI 9175 1 IM
US CA TB 117-2013

Colours are indicative. Pedrali reserves the right to modify or upgrade the product without prior notice.
I colori sono indicativi. Pedrali si riserva la facoltà di apportare modifiche o migliorie senza alcun preavviso.

Fire retardant fabric / Tessuto ignifugo

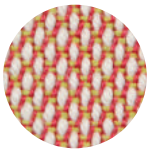

G59

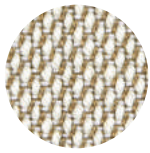

G66

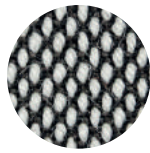

G63

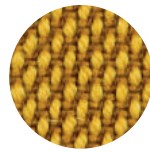

G67

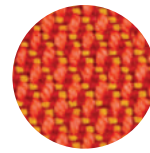

G69

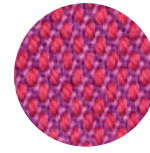

G60

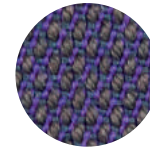

G61

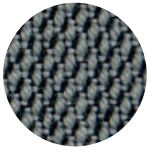

G62

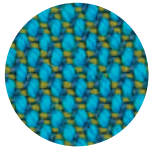

G68



G64



G65

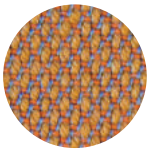

G190

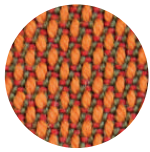

G191

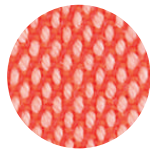

G192

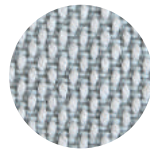

G193

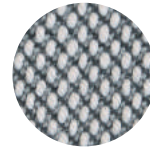

G194

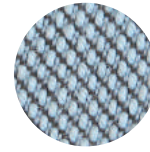

G195

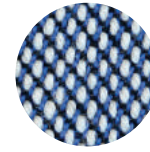

G196

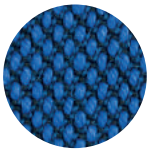

G197



G71

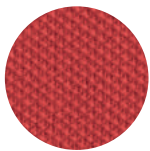

G72



G74

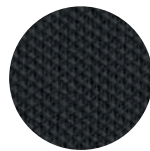

G70

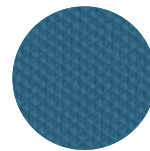

G75

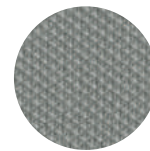

G73

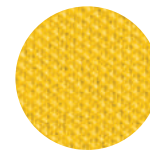

G78



AS/NZS 1530.3
 AS/NZS 3837 CLASS 2
 BS 5852 PART 1
 BS 5852 CRIB 5 with treatment
 DIN 4102 B2
 EN 1021 - 1/2
 IMO FTP CODE 2010 PART 8
 NF D 60 013
 NFPA 260
 ÖNORM B1/Q1
 SN 198 898 5.3 with treatment
 UNI 9175 CLASSE 1 IM
 US CA TB 117-2013

Colours are indicative. Pedrali reserves the right to modify or upgrade the product without prior notice.
 I colori sono indicativi. Pedrali si riserva la facoltà di apportare modifiche o migliorie senza alcun preavviso.

Fire retardant fabric / Tessuto ignifugo

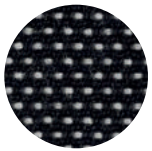

G100

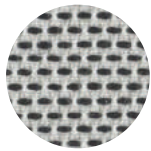

G101

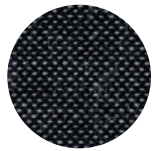

G102



DIN 4102 B2
EN 1021 - 1/2
IMO FTP CODE 2010 PART 8
NF D 60 013
ÖNORM B1/Q1
US CA TB 117-2013
UNI 9175 CLASSE 1 IM

Fire retardant fabric / Tessuto ignifugo



G120



G121

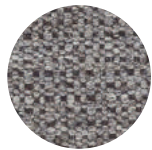

G122



DIN 4102 B2
EN 1021 - 1/2
ÖNORM B1/Q1
NFPA 260
NF D 60 013
UNI 9175 CLASSE 1 IM
US CA TB 117-2013

Fire retardant fabric / Tessuto ignifugo

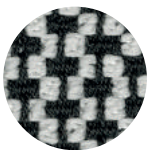

G130

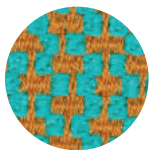

G131

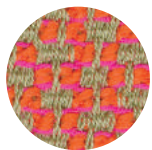

G132

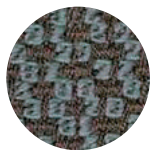

G133



BS 5852:1979 (part 1)
BS 5852:2006 (part 2) Crib 5
DIN 4102-1 B2
EN 1021 -1 and -2
EN 13501-1
FAR 25.853 (12 sec. vertical)
IMO: 2014/90/EU
US CA TB 117-2013
UNI 9175

Fire retardant fabric / Tessuto ignifugo

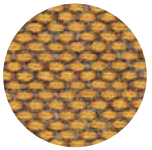

G140

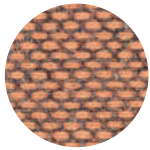

G141

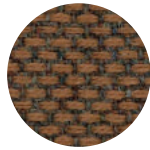

G142

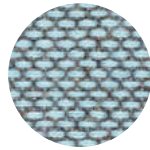

G143

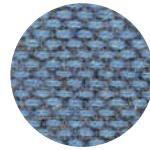

G144

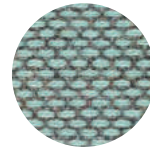

G145

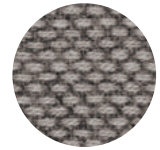

G146



AS/NZS 1530.3
BS 5852 PART 1
BS 5852 CRIB 5 with treatment
BS 5852 IGNITION SOURCE 3
EN 1021 - 1/2
IMO FTP CODE 2010 PART 8
NF D 60013
ÖNORM B1/Q1
UNI 9175 CLASSE 1IM
US CA TB 117-2013

Fire retardant fabric / Tessuto ignifugo

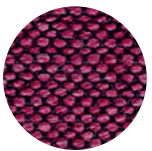

G150

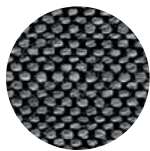

G151

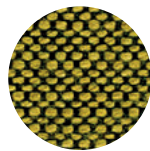

G152

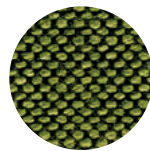

G153

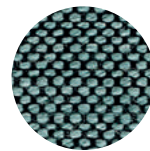

G154

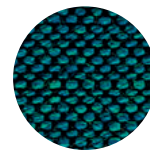

G155

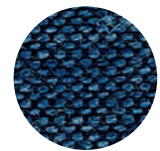

G156



BS 5852 CRIB 5
EN ISO 1021 part 1&2
IMO FTP CODE 2010: PART 8
UNI 9175 CLASSE 1 IM
US CA TB 117-2013

Fire retardant fabric / Tessuto ignifugo

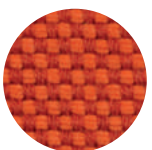

G170

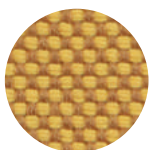

G171

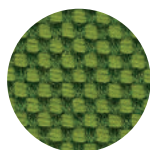

G172

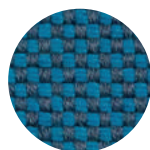

G173

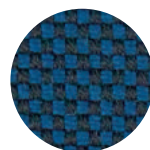

G174

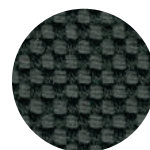

G175



G176



BS 5852:1979 (part 1)
BS 5852:2006 (part 2) Crib 5
DIN 4102-1 B2
EN 13501-1
EN 1021 -1 and -2
FAR 25.853 (12 sec. vertical)
IMO: 2014/90/EU
US CA TB 117-2013

Colours are indicative. Pedrali reserves the right to modify or upgrade the product without prior notice.
I colori sono indicativi. Pedrali si riserva la facoltà di apportare modifiche o migliorie senza alcun preavviso.



Fire retardant fabric / Tessuto ignifugo



G07



G06



G09



G01



G04

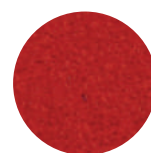

G08



BS 5852 Part 1 0,1
BS EN 1021 1&2
BS EN 1021-1
ÖNORM B 3825-B2-3800-Q1 UK
NF P 92-503 M3
CATB 117-2013



Fire retardant fabric / Tessuto ignifugo



G160



G161



G162



G163



G164

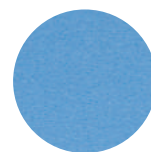

G165



G166



G167



G168



G169



BS 5852 Crib 5 with treatment
BS 5852 PART 1
DIN 4102 B2
EN 1021 - 1/2
IMO FTP CODE 2010: PART 8
NF D 60 013
NFPA 260
SN 198 898 5.3 with treatment
US CA TB 117-2013
UNI 9175 CLASSE 1 IM



Fire retardant fabric / Tessuto ignifugo



G180



G181

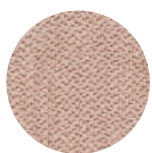

G182

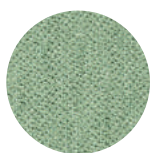

G183

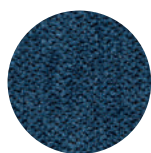

G184

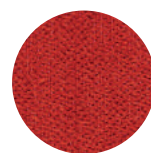

G185



BS 5852 Crib 5
BS 5852 part 1
BS 5867 Part 2 type B
DIN 4102 B1
EN 1021-1/2
IMO FTP Code 2010:Part 8

NF D 60 013
NF P 92 57 M1
ONORM B1/Q1
SN 198 898 5.2
UNI 9175 CLASSE 1 IM
US CA TB 117-2013

Colours are indicative. Pedrali reserves the right to modify or upgrade the product without prior notice.
I colori sono indicativi. Pedrali si riserva la facoltà di apportare modifiche o migliorie senza alcun preavviso.

Category H

Fire retardant simil leather / Finta pelle ignifuga

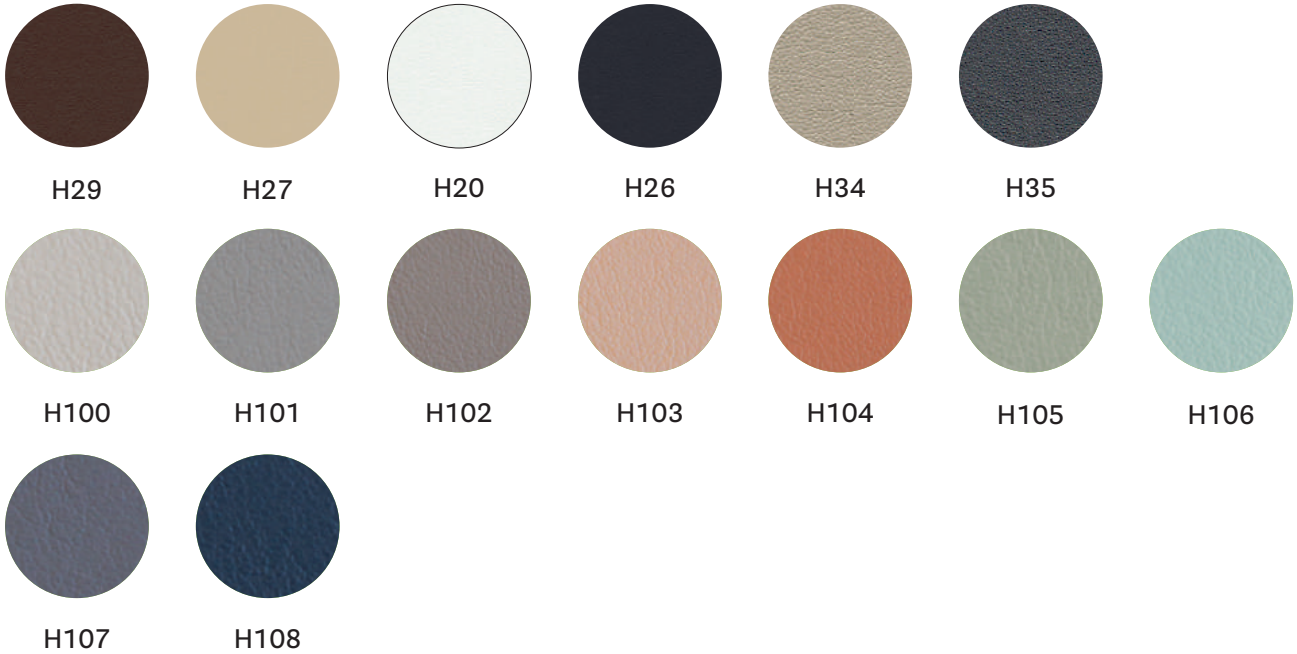

 BS 5852 Crib 5
 BS 5852 Source 1
 EN 1021 PART 1-2
 IMO FTP Code 2010
 UNI 9175 CLASSE 1 IM
 US CA TB 117-2013

Fire retardant simil leather / Finta pelle ignifuga





 BS 5852 Crib 5
 BS 5852 PART 1-2
 IMO resolution A.652 (16): 1989
 EN 1021 PART 1-2
 UNI 9175 CLASSE 1 IM
 US CA TB 117-2013

Colours are indicative. Pedrali reserves the right to modify or upgrade the product without prior notice.
 I colori sono indicativi. Pedrali si riserva la facoltà di apportare modifiche o migliorie senza alcun preavviso.

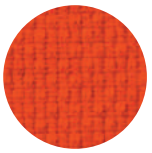
Fire retardant fabric / Tessuto ignifugo

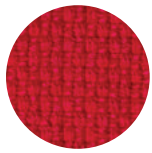

H60



H61



H62

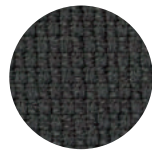

H63

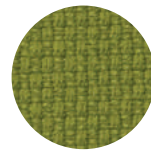

H64



BS EN 1021 1&2
BS EN 1021-1
BS 5852 PART 1 0, 1
US CA TB 117-2013
UNI 9175 CLASS 1 IM

Fire retardant velvet / Velluto ignifugo



H41

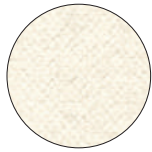

H40

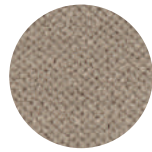

H44

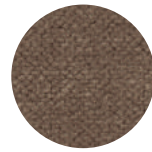

H45



H46

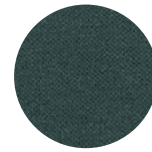

H51

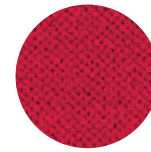

H53

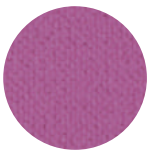

H52

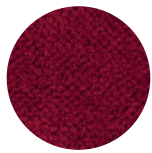

H42



H47

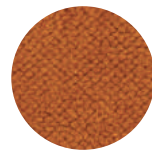

H48

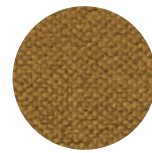

H43

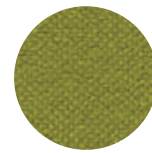

H49

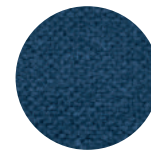

H50



BS 5852-Part 1 0,1
DIN 4102 B1
EN 1021-1&2
IMO MSC 307(88) Annex 1 Part 7-8
NF P 92-503-507 M1
UNI 9177 - Classe 1
US CA TB 117-2013

Category N



Fire retardant fabric / Tessuto ignifugo

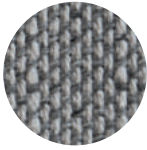

N01

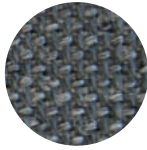

N02

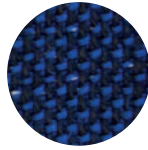

N03

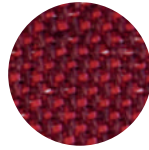

N04

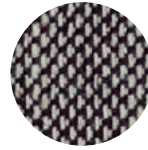

N05



AS/NZS 3837
BS 5852 PART 1
DIN 4102 B2
EN 1021 - 1/2
US CA TB 117-2013



Fire retardant velvet / Velluto ignifugo



N20



N21

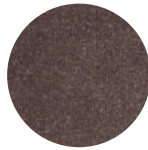

N22



N23



N24



N25



N26

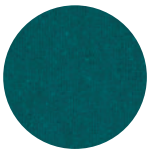

N27



BS 5852 Crib 5
BS 5852 part 1
DIN 4102 B1
EN 1021-1/2
IMO FTP Code 2010:Part 8
NF P 92 507 M1
ONORM B1/Q1
SN 198 898 5.2
UNI 9175

Category P

Mid grain leather / Pelle mezzo fiore



PBI



PSA



PGC



PGA

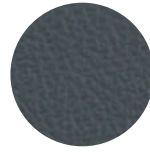

PGR



PBE



PTA



PMA



PNE



PRO



PTE



PGN



BS 5852:1979
BS EN 1021-1-2:2006

Perforated mid grain leather / Pelle mezzo fiore traforata



PGCF

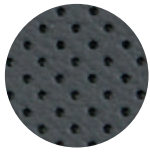

PGRF



PMAF

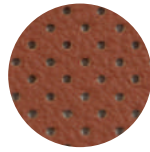

PTEF



BS 5852:1979
BS EN 1021-1-2:2006

For Vic and Vic Metal
Per Vic e Vic Metal

PEDRALI PRICELIST | Edition October 2019

Print Intese Grafiche
Copyright © 2019, Pedrali S.p.A. All rights reserved



The mark of
responsible forestry

Cerca i prodotti certificati FSC™
Look for FSC™ certified products



Weights, measurements and colours are indicative. Pedrali reserves the right to modify or upgrade the products without prior notice.

Pesi, dimensioni e colori sono indicativi. Pedrali si riserva la facoltà di apportare modifiche o migliorie senza alcun preavviso.

Industrial property right | Diritto di proprietà industriale

Pedrali's Collections are worldwide protected by the industrial property right and patents.

Tutte le collezioni Pedrali sono protette nel mondo dal diritto di proprietà industriale e da brevetti registrati.