

The background of the entire page is a light gray topographic map with white contour lines. The lines represent elevation and are more densely packed on the right side of the image, indicating a steeper slope.

VERGÉS

2019
2020

New
Collections

Company

Origen P.4

Collections

ABC Collection P.12

Bernardes Collection P.26

Glöwr Collection P.38

Kimmi Collection P.52

Mim Collection P.64

Naoshima Collection P.76

Product information

ABC Information P.92

Bernardes Information P.96

Glöwr Information P.98

Kimmi Information P.102

Mim Information P.106

Naoshima Information P.110

General finishes P.112



Las sillas y muebles Vergés son el resultado de la conjunción de experiencia, vocación, calidad y diseño. Producto de una empresa familiar nacida en Tortellà, una localidad de la Alta Garrotxa, sigue desarrollando su actividad en el mismo lugar desde su fundación hace casi cincuenta años. Una permanencia que ayuda a entender la filosofía de la empresa, su forma de ser y su manera de trabajar.

Vergés chairs and furniture are the result of a combination of experience, vocation, quality and design. A family company born in Tortellà, a town in Alta Garrotxa, Vergés has been carrying out its business in the same location for almost 50 years. Such continuance provides insight into the company's philosophy, personality and way of working.

Fundada por el matrimonio Vergés Picart, la empresa comparte las raíces de la comarca en que está radicada. La Garrotxa, en la provincia de Girona, a medio camino entre el Mediterráneo y los Pirineos, es un territorio rural privilegiado, único, apartado de las grandes ciudades. Una orografía de origen volcánico que ha condicionado el paisaje y la vegetación, con espectaculares bosques de hayas que crecen sobre coladas de lava enfriadas hace miles de años.

En cualquier estación del año, la Garrotxa es un estallido de colores. Todos los matices, del ocre al negro, del verde al rojizo, configuran un paisaje visual que marca profundamente a la gente de la comarca.

Paleta de colores espléndida y madera de haya. Inspiración más que sobrada para un fabricante de mobiliario. En sus inicios, Vergés era un pequeño taller dedicado a la fabricación de sillas artesanales de boga, algo muy ligado al territorio. Desde esos orígenes, su producción ha evolucionado junto al crecimiento de la empresa y siempre con una mirada hacia el norte a aquellos países con una sólida tradición en el diseño y el mobiliario de calidad.

Una evolución imprescindible para mantenerse en un mercado cada vez más exigente que pasa por emplear las últimas tecnologías, optimizar los recursos y convertir el taller original en una moderna y dinámica factoría con alrededor de 50 empleados. Al mismo tiempo se ha llevado a cabo un relevo generacional y, actualmente, son Esteve y Joan, hijos del matrimonio fundador, quienes se hallan impulsando la nueva etapa de la empresa.

Pese a esta transformación, Vergés no quiere renunciar a sus orígenes, al oficio, la tradición y la atención por el detalle. Unos principios reflejados en las colecciones actuales, que establecen un diálogo entre lo artesanal y lo moderno, donde la innovación va de la mano de la calidad en los materiales, el diseño y los buenos acabados.

Founded by the Vergés Picart couple, the company shares its roots with the region in which it's located. In the province of Girona, La Garrotxa is found halfway between the Mediterranean and the Pyrenees. It is a privileged and unique rural region removed from large cities. Its volcanic orography has conditioned the landscape and vegetation, endowing it with spectacular beech tree forests that grow on tracks of lava cooled down thousands of years ago.

At any time of year, La Garrotxa is an explosion of colour. From ochre to black, and green to copper, each nuance contributes to a visual landscape that leaves a deep mark on the region's people.

A splendid palette of colours and beechwood. More than enough inspiration for a furniture manufacturer. At its start, Vergés was a small workshop dedicated to the production of artisanal wicker chairs, as was the tradition in the region. From those origins, its production has evolved as business has grown, always with a view toward northern countries with a strong tradition in design and quality furniture.

Such an evolution has been essential to keeping up with an ever-more demanding market and has meant using the latest technology, optimizing resources and turning the original workshop into a modern and dynamic factory employing approximately 50 people. At the same time, there was a generational turnover and, today, Esteve and Joan, the founders' children, are driving this new stage of the company.

Despite this transformation, Vergés refuses to give up its roots, vocation, tradition and attention to detail. These principles are reflected in its current collections, which establish a dialogue between artisanship and modernity, where innovation goes hand in hand with quality material, design and good finishes.

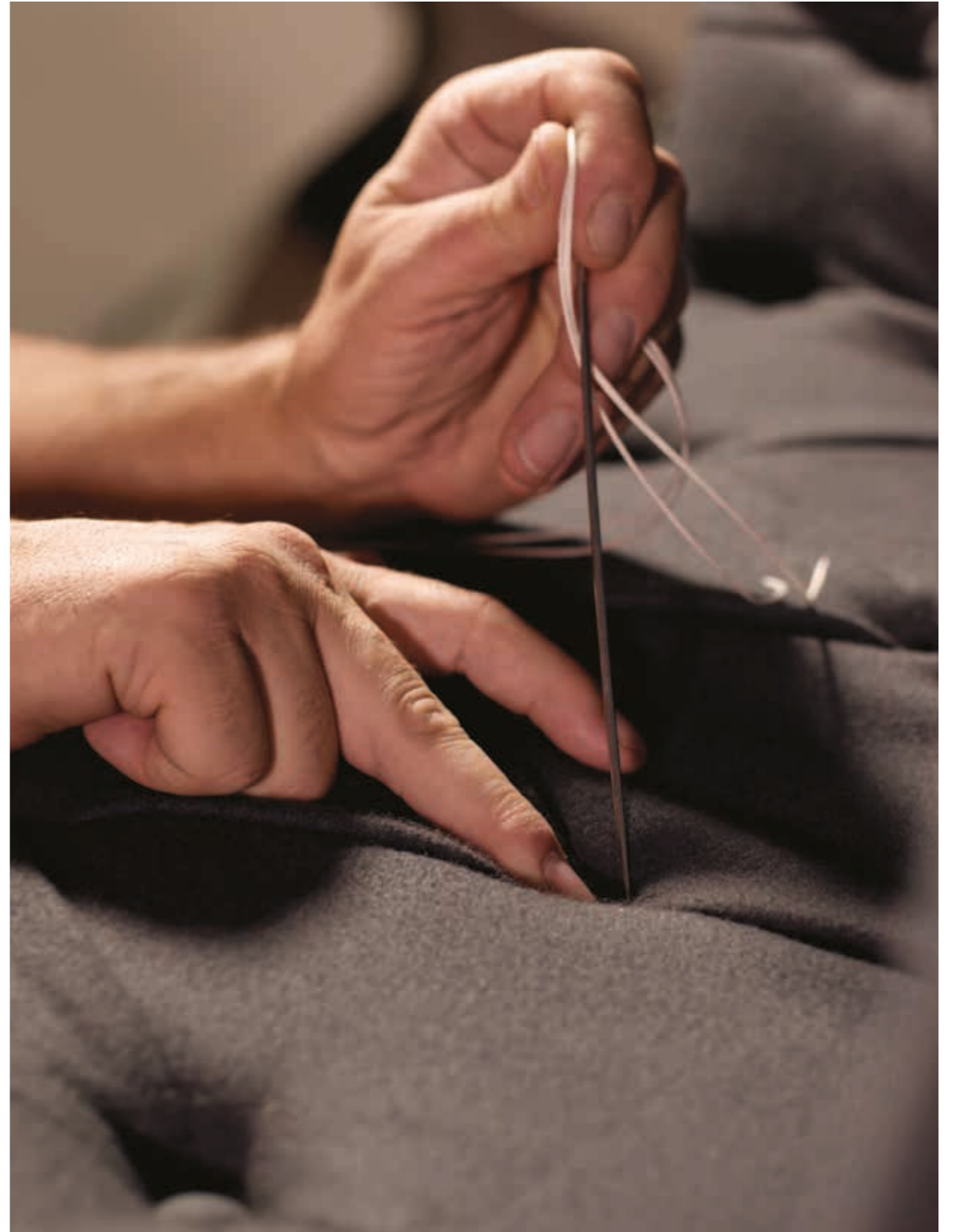

Hoy, las sillas y muebles Vergés se han convertido en un referente para arquitectos e interioristas que buscan colecciones de mobiliario contemporáneo y de alta calidad para la hostelería y espacios públicos.

El mobiliario actual de Vergés ha sido diseñado y desarrollado por figuras relevantes del diseño y elaborado con sumo cuidado en los talleres de la propia empresa, produciendo unos muebles que aseguran un óptimo resultado en la imagen visual de cualquier instalación.

Carácter, resistencia, cumplimiento de los plazos de entrega y un servicio posventa que se ajusta a las exigencias de cualquier proyecto contract.

Además, como apasionados del interiorismo y el diseño, Vergés entiende que cada proyecto es un mundo en sí mismo y que, por ese motivo, la adaptabilidad es otra de las claves para ser apreciados hoy en día.

Esto se traduce en la capacidad de amoldarse a las necesidades de todo cliente, ofreciéndole la personalización de los acabados de cualquier modelo del catálogo con tejidos de alta calidad y una amplia paleta de materiales y colores.

Today, Vergés chairs and furniture represent a benchmark for architects and interior designers in search of contemporary and high-quality furniture collections for hotels, restaurants and public spaces.

The Vergés furniture of today was designed and developed by renowned design personalities and manufactured with the utmost care at the company's own workshops, yielding furniture that ensures an optimal result in the visuals of any installation.

Character, endurance, on-time deliveries and after-sales servicing adapted to the demands of any project contract.

And with its passion for interior design, Vergés understands that each project is a world of its own, making adaptability a key to success in today's world. This translates to the ability to adapt to the needs of any client, offering customized finishes for any model from the catalogue, high-quality fabrics and a wide range of materials and colours.



ABC Collection



1

2

1. ABC table metal base code 974 – Base: powder coated RAL 7044 matte.
/ ABC wooden top code 977 Ø70 cm – Top: ash veneer lacquered RAL 7044 PO AN.
2. ABC chair code 970 – Frame: powder coated RAL 7044 matte / Seat and backrest:
beech veneer dyed Grey 74 EM / Seat and backrest: upholstered Gabriel Note 68156.

ABC Collection

– by Lázaro
Rosa Violán

En el mundo del lenguaje, ABC representa el abecedario, también nos acerca al mundo de las aulas y los colegios, en el que Lázaro Rosa Violán se ha inspirado para crear esta colección de sillas y mesas elementales. Las sillas ABC son ligeras y equilibradas, combinan un gran confort con la resistencia y durabilidad, y evocan un cierto carácter de atemporalidad.



P.14 P.15 ABC armrest chair code 971 / Frame: powder coated RAL 9004 matte / Seat and backrest: beech veneer dyed Grey 79 EM / Seat: upholstered Gabriel Harmony 1113.

In the world of language, ABC represents the alphabet and brings us closer to schools and classrooms, where Lázaro Rosa Violá found the inspiration to create this collection of elemental chairs and tables. ABC chairs are lightweight and balanced, combining great comfort with strength and durability. They evoke a certain timelessness.



1. ABC armrest chair code 973 / Frame: powder coated RAL 7030 matte / Seat and backrest: ash veneer natural varnished EM / Legs: ash solid wood natural varnished EM / Seat: upholstered Gabriel Note 61148.
2. ABC chair code 972 / Frame: powder coated RAL 6013 textured / Seat and backrest: ash veneer natural varnished EM / Legs: ash solid wood natural varnished EM / Seat: upholstered Gabriel Harmony 4104.



ABC chair code 972 / Frame: powder coated RAL 5004 satin / Seat and backrest: ash veneer lacquered RAL 5004 PO AN / Legs: ash solid wood lacquered RAL 5004 PO AN / Seat: upholstered Gabriel Note 66144.



1

2

La colección ofrece una amplia gama lo cual la hace muy versátil para diferentes entornos. ABC está formada por cuatro modelos de sillas (con o sin brazos, apilables con patas metálicas o en madera maciza) y dos mesas abatibles, de sobres redondos o cuadrados, con diferentes acabados.

+ Info P.92

The collection offers a wide variety, making it very versatile and apt for use in different settings. ABC comprises four chair models (with or without arms, stackable, with metal or solid wood) and two drop-leaf tables, with round or square tabletops and different finishes.

+ Info P.92



1. ABC chair code 970 / Frame: powder coated RAL 7044 matte / Seat and backrest: beech veneer dyed Grey 74 EM / Seat and backrest: upholstered Gabriel Note 68156.
2. ABC table metal base code 974 - Base: powder coated RAL 7044 matte.
/ ABC wooden top code 977 Ø70 cm - Top: ash veneer lacquered RAL 7044 PO AN.



ABC Collection



P.20 to P.23 1. ABC table metal base code 974 – Base: powder coated RAL 1013 matte. / ABC wooden top code 977 Ø60 cm – Top: ash veneer lacquered RAL 1027 PO AN.
2. ABC armrest chair code 973 / Frame: powder coated RAL 1027 satin / Seat and backrest: ash veneer lacquered RAL 1027 PO AN / Legs: ash solid wood lacquered RAL 1027 PO AN / Seat and backrest: upholstered Gabriel Note 62041.



1

2



ABC Collection



P.24 P.25 ABC armrest chair code 973 / Frame: powder coated RAL 7030 matte
/ Seat and backrest: ash veneer natural varnished EM / Legs: ash solid wood natural varnished EM
/ Seat: upholstered Gabriel Note 61148.

Bernardes Collection



1. Bernardes lounge code 293 / Frame: beech solid wood dyied White 93 EM
/ Backrest: cane mesh dyied White 93 EM / Seat: upholstered Gabriel Mood 1105.
2. Bernardes lounge code 293 / Frame: beech solid wood dyied Pink 32 EM
/ Backrest: cane mesh dyied Pink 32 EM / Seat: upholstered leather Penelopegi Nuvola P0151.

– by Andreu
Carulla

La colección Bernardes, creada por Andreu Carulla, pretende capturar la imagen de austeridad y discreción que asociamos a los conventos románicos medievales. El resultado de esta sugerente idea es unir en la colección la tradición, la atemporalidad y la sobriedad de aquello que debe soportar el paso del tiempo.



P.28 P.29 Bernardes chair code 290 / Frame: beech solid wood dyied Grey 74 EM / Backrest: cane mesh dyied White 13 EM / Seat: upholstered Gabriel Mood 1104.

Bernardes collection, created by Andreu Carulla, aims to capture the image of austerity and discretion that we associate with medieval Roman convents. As a result of this suggestive idea, the collection combines tradition, timelessness and the sobriety of that which must tolerate the passage of time.



1. Bernardes lounge code 293 / Frame: beech solid wood dyied White 93 EM / Backrest: cane mesh dyied White 93 EM / Seat: upholstered Gabriel Mood 1105.
2. Bernardes chair code 290 / Frame: beech solid wood dyied Grey 74 EM / Backrest: cane mesh dyied Grey 74 EM / Seat: upholstered Gabriel Mood 1104.
3. Bernardes chair code 290 / Frame: beech solid wood dyied White 13 EM / Backrest: cane mesh dyied White 13 EM / Seat: upholstered Gabriel Mood 3101.

Bernardes, confortables y sofisticadas, en sus versiones de silla, sillón y banco, combinan la madera de haya, la tela o cuero tapizados y la cestería de ratán artesanal, unos materiales que las hacen robustas y duraderas.

+ Info P.96

Bernardes, comfortable and sophisticated in its chair, armchair and bench versions, combine beechwood, upholstered fabric or leather, and artisan wickerwork to make robust and long-lasting pieces.

+ Info P.96





1



2

1. Bernardes lounge code 293 / Frame: beech solid wood dyied Pink 32 EM
/ Backrest: cane mesh dyied Pink 32 EM / Seat: upholstered leather Penelopegi Nuvola P0151.
2. Bernardes bench code 292 / Frame: beech solid wood dyied White 13 EM
/ Backrest: cane mesh dyied White 13 EM / Seat: upholstered Gabriel Mood 1105.



Bernardes Collection



P.34 P.35 Bernardes lounge code 293 / Frame: beech solid wood dyied Blue 54 EM
/ Backrest: cane mesh dyied Blue 54 EM / Seat: upholstered Spradling Dolce Indigo 6725.



1

2

1. Bernardes bench code 292 / Frame: beech solid wood dyied White 13 EM
/ Backrest: cane mesh dyied White 13 EM / Seat: upholstered Gabriel Mood 1105.
2. Bernardes lounge code 293 / Frame: beech solid wood dyied White 13 EM
/ Backrest: cane mesh dyied White 13 EM / Seat: upholstered Gabriel Mood 1105.

Glöwr Collection



1. Glöwr table wooden base code 783 – Base: beech solid wood dyied Grey 74 EM. / Glöwr wooden top code 009, 80 x 80 cm – Top: Plywood laminated Infinity Surf F7923. Edge dyied Grey 74 EM.
2. Glöwr chair code 780 / Frame: solid beech wood dyied Orange 83 EM / Seat and backrest: beech veneer dyied Orange 83 EM.

Glöwr Collection

– by Claire
Davies

Diseñada por Claire Davies, Glöwr es el tipo de silla cálida y acogedora. Es una pieza sobria, robusta y duradera. Sus líneas sencillas y tranquilas, junto al uso de la madera, aportan cierta domesticidad y calidez a los espacios de restauración y hostelería.



P.40 Glöwr chair code 780 / Frame: solid beech wood dyied White 13
/ Backrest: beech veneer dyied White 13 EM / Seat: upholstered Gabriel Fame 68148.
P.41 Glöwr chair code 780 / Frame: solid beech wood dyied Grey 74 EM
/ Backrest: beech veneer dyied Grey 74 EM / Seat: upholstered Gabriel Fame 61136.

Designed by Claire Davies, the Glöwr is a warm and welcoming chair. It's a sober, robust and long-lasting piece. Its simple and smooth lines, together with the use of wood, provide domesticity and warmth to restaurant and hotel spaces.





P.42 Glöwr chair code 780 / Frame: solid beech wood dyied White 13 EM / Backrest: beech veneer dyied White 13 EM / Seat: upholstered Gabriel Fame 61131.
P.43 1. Glöwr table wooden base code 783 – Base: beech solid wood dyied Grey 74 EM. / Glöwr wooden top code 009, 80 x 80 cm – Top: Plywood laminated Infinity Surf F7923. Edge dyied Grey 74 EM.
2. Glöwr chair code 780 / Frame: solid beech wood dyied White 13 EM / Backrest: beech veneer dyied White 13 EM / Seat: upholstered Gabriel Fame 61131.





Glöwr Collection



P.44 P.45 1. Glöwr stool code 782 / Frame: solid beech wood dyied Green 66 EM / Seat and backrest: beech veneer dyied Green 66 EM.

2. Glöwr stool code 782 / Frame: solid beech wood dyied Grey 74 EM / Backrest: beech veneer dyied Grey 74 EM / Seat and front backrest: upholstered Gabriel Fame 68148.

3. Glöwr lounge code 781 / Frame: solid beech wood dyied Grey 74 EM / Backrest: beech veneer dyied Grey 74 EM / Seat: upholstered Gabriel Fame 68148.

La colección Glöwr se compone de una silla apilable, taburete alto, sillón lounge y mesas, todas ellas con estructura de madera de haya y piezas de unión en latón que aportan un acento refinado al conjunto.

The Glöwr collection includes a stackable chair, high stool, lounge armchair and tables, all with a beechwood frame and brass joints that provide a refined touch.

1. Glöwr chair code 780 / Frame: solid beech wood dyied Grey 74 EM / Backrest: beech veneer dyied Grey 74 EM / Seat: upholstered Gabriel Fame 61136.
2. Glöwr table wooden base code 783 - Base: beech solid wood dyied Grey 74 EM. / Glöwr wooden top code 009 80 x 80 cm - Top: beech plywood dyied Green 63 EM.
3. Glöwr chair code 780 / Frame: solid beech wood dyied White 13 EM / Backrest: beech veneer dyied White 13 EM / Seat: upholstered Gabriel Fame 68148.
4. Glöwr chair code 780 / Frame: solid beech wood dyied Grey 74 EM / Seat and backrest: beech veneer dyied Green 63 EM.
5. Glöwr table wooden base code 783 - Base: beech solid wood dyied Grey 74 EM. / Glöwr wooden top code 009, 80 x 80 cm - Top: plywood laminated Infinity Surf F7923. Edge dyied Grey 74 EM.
6. Glöwr chair code 780 / Frame: solid beech wood dyied Grey 74 EM / Backrest: beech veneer dyied Grey 74 EM / Seat and front backrest: upholstered Gabriel Fame 61136.





Glöwr Collection



P.48 P.49 Glöwr lounge code 781 / Frame: solid beech wood dyied Blue 54 EM
/ Backrest: beech veneer dyied Blue 54 EM / Seat: upholstered Gabriel Fame 60017.

Mediante combinaciones con la tapicería, piel y los tonos de madera, los tres asientos permiten múltiples variaciones y cambios de aspecto.
+ Info P.98

Through combinations of tapestry, leather and wood tones, it's possible to modify the chairs in a variety of ways and change their appearance.
+ Info P.98



P.50 P.51 Glöwr lounge code 781 / Frame: solid beech wood dyied White 13 EM
/ Backrest: beech veneer dyied White 13 EM / Seat: upholstered leather Penelopeggi Nuvola P0151.

1. Kimmi chair code 255 / Frame: powder coated RAL 9003 matte / Seat: beech veneer lacquered RAL 9003 EM / Backrest: beech veneer dyed White 93 EM.
2. Kimmi table metal base code 257 – Base: powder coated RAL 9003 matte.
/ Kimmi top code 260, Ø60 cm – Top: Beech veneer dyed White 93 EM. Metal edge powder coated RAL 9003 matte.



2



Kimmi Collection

– by Roger
Vancells

Diseñada por Roger Vancells, Kimmi es una silla expresiva, de líneas sobrias y contemporáneas. Conecta de manera honesta e ingeniosa dos piezas de madera contrachapada para construir el asiento y el respaldo. Jugando con los acabados y combinando maderas naturales o lacadas, así como los tapizados, se consiguen sillas con equilibradas composiciones cromáticas.



P.54 P.55 Kimmi chair code 255 / Frame: powder coated RAL 5004 satin / Seat: upholstered Gabriel Atlantic 60011 / Backrest: ash veneer lacquered RAL 5004 PO AN.

Designed by Roger Vancells, the Kimmi is an expressive chair with sober and contemporary lines. It ingeniously and naturally joins two pieces of laminated wood to form the seat and back. Chairs with balanced chromatic compositions are created by playing with finishes and combining natural and lacquered woods, as well as upholsteries.



1. Kimmi chair code 256 / Frame: powder coated RAL 7030 matte
 / Seat and backrest: ash veneer lacquered RAL 7030 PO AN
 / Legs: ash solid wood lacquered RAL 7030 PO AN.
 2. Kimmi chair code 256 / Frame: powder coated RAL 1013 matte
 / Seat and backrest: ash veneer varnished natural EM
 / Legs: ash solid wood varnished natural EM.



Kimmi Collection



1. Kimmi chair code 253 / Frame: powder coated RAL 6006 matte / Seat: upholstered Spradling
 Dolce Moss 6717 / Backrest: ash veneer varnished natural EM.
 2. Kimmi chair code 256 / Frame: powder coated RAL 1013 matte / Seat and backrest:
 ash veneer varnished natural EM / Legs: ash solid wood varnished natural EM.

Kimmi es una colección que por su diseño se adapta a los ambientes de trabajo informales y a los espacios de restauración modernos. Se presenta en cuatro tipologías de estructura, con patas de tubo metálico o de madera, patas de patín o bien giratoria de cuatro radios.

Because of its design, the Kimmi collection can be adapted to both casual work environments and modern restaurant spaces. It comes in four frame types: metal or wood tube legs, a sled base or a swivel base with four spokes.

1. Kimmi chair code 253 / Frame: powder coated RAL 6006 matte / Seat: upholstered Spradling Dolce Moss 6717 / Backrest: ash veneer varnished natural EM.
2. Kimmi chair code 254 / Frame: powder coated RAL 6006 matte / Seat and backrest: ash veneer lacquered RAL 6006 PO AN.
3. Kimmi table metal base code 258 – Base: Powder coated RAL 6006 matte. / Kimmi top code 260, Ø70 cm – Top: ash veneer varnished natural EM. Metal edge powder coated RAL 6006 matte.
4. Kimmi table metal base code 258 – Base: powder coated RAL 6006 matte. / Kimmi top code 260, Ø70 cm – Top: Dekton Edora textured. Metal edge powder coated RAL 6006 matte.
5. Kimmi chair code 256 / Frame: powder coated RAL 7030 matte / Seat and backrest: ash veneer lacquered RAL 7030 PO AN / Legs: ash solid wood lacquered RAL 7030 PO AN.
6. Kimmi chair code 256 / Frame: powder coated RAL 1013 matte / Seat and backrest: ash veneer varnished natural EM / Legs: ash solid wood varnished natural EM.



Las sillas se complementan con mesas de tres alturas distintas. Construidas con estructura tubular metálica lacada, sus sobres están embutidos en un marco metálico perimetral.

+ Info P.102

The chairs are complemented by tables of three different heights. Built with a lacquered metal tubular structure, the tabletop is framed by a metal border.

+ Info P.102



2



Kimmi Collection



P.60 P.61 1. Kimmi table metal base code 259 – Base: powder coated RAL 8000 textured. / Kimmi top code 260, Ø50 cm – Top: Dekton Zenith matte. Metal edge powder coated RAL 8000 textured.

2. Kimmi table metal base code 258 – Base: powder coated RAL 6006 matte. / Kimmi top code 260, Ø70 cm – Top: Dekton Edora textured. Metal edge powder coated RAL 6006 matte.

1. Kimmi chair code 255 / Frame: powder coated RAL 5004 satin / Seat: upholstered Gabriel Cura 60111 / Backrest: ash veneer lacquered RAL 5004 PO AN.
2. Kimmi chair code 255 / Frame: powder coated RAL 3012 satin / Seat: upholstered Spradling Valencia Nectarine 107-6003 / Backrest: ash veneer lacquered RAL 3012 PO AN.



1

2

Mim Collection

– by Tarruella Trenchs
Studio

Mim chair code 754 / Frame: powder coated RAL 7044 matte / Seat: upholstered Crevin Dolce Imp 75
/ Backrest: beech solid wood dyied white 93 EM.

Mim Collection

65

Mim es una amplia colección de gran ligereza visual diseñada por Tarruella Trenchs Studio. Tanto su versatilidad en acabados, como su lenguaje atemporal y honesto, la hacen muy adecuada para equipar interiores rústicos y sofisticados, de restaurantes, cafeterías y zonas de espera.

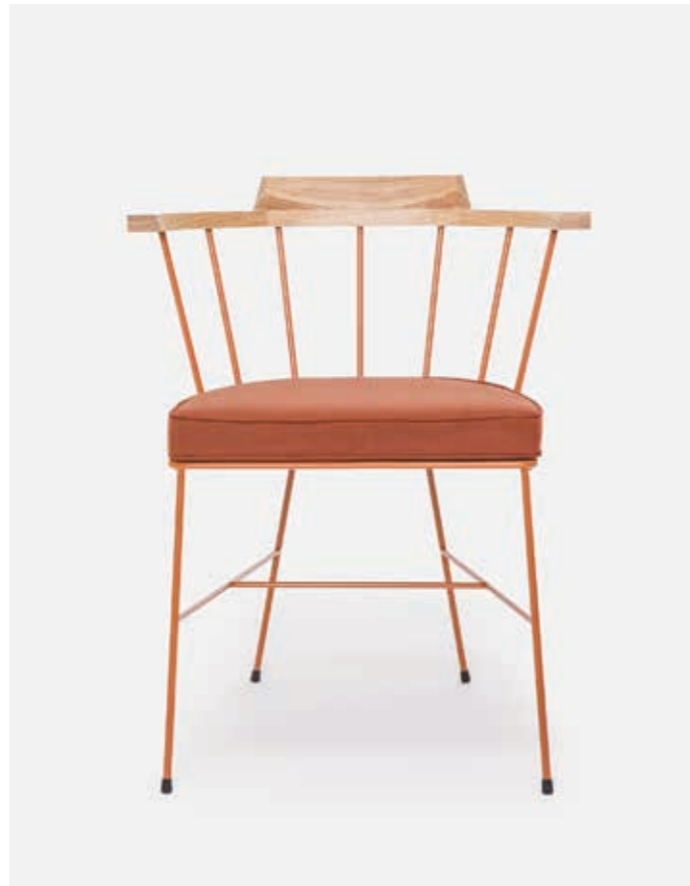

P.66 P.67 Mim chair code 754 / Frame: powder coated RAL 8023 matte / Seat: upholstered Gabriel Gocheck 63080 / Backrest: oak solid wood varnished natural EM.

Mim is an extensive, visually lightweight collection designed by Tarruella Trenchs Studio. Both its versatility in finishes and its timeless and honest language make it perfectly suited for the rustic and sophisticated interiors of restaurants, cafeterias and waiting areas.



En Mim, las sillas, bancos, taburetes y mesas combinan con sutileza las livianas estructuras metálicas con la calidez de los asientos textiles, los respaldos de madera maciza y la robustez de la piedra en el sobre de las mesas.

+ Info P.106

In Mim, the chairs, benches, stools and tables subtly combine lightweight metal frames with warm fabric seats, solid wood backs and robust stone tabletops.

+ Info P.106



1. Mim table metal base code 762 - Base: powder coated RAL 6006 matte. / Mim top code 758, Ø40 cm - Top: Dekton Galema / Walnut solid wood edge, varnished natural EM.
2. Mim bench code 757 / Frame: powder coated RAL 6006 matte / Seat: upholstered Gabriel Gocheck 61139 / Backrest: walnut solid wood varnished natural EM.
3. Mim cushion code 759 / Upholstered Gabriel Gocheck 61139.



Mim Collection



P.70 1. Mim chair code 754 / Frame: powder coated RAL 7044 matte / Seat: upholstered Gabriel Gocheck 60093 / Backrest: oak solid wood varnished natural EM.
2. Mim table metal base code 764 - Base: Powder coated RAL 7044 matte. / Mim top code 758, Ø70 cm - Top: Infinity Surf F7923. Oak solid wood edge, varnished natural EM.
P.71 Mim chair code 754 / Frame: powder coated RAL 7039 matte / Seat: upholstered Gabriel Gocheck 60093 / Backrest: oak solid wood varnished natural EM.



1. Mim chair code 754 / Frame: powder coated RAL 8023 matte / Seat: upholstered Gabriel Gocheck 63080 / Backrest: beech solid wood lacquered RAL 8023 AN.
2. Mim bench code 757 / Frame: powder coated RAL 5004 matte / Seat: upholstered Gabriel Gocheck 60080 / Backrest: beech solid wood dyied White 93 EM.
3. Mim stool code 755 / Frame: powder coated RAL 5004 matte / Seat: upholstered Gabriel Gocheck 66140 / Backrest: beech solid wood dyied White 93 EM.



Mim Collection



P.74 P.75 1. Mim chair code 754 / Frame: powder coated RAL 9004 matte / Seat: upholstered Gabriel Gocheck 60084 / Backrest: oak solid wood varnished natural EM.
2. Mim table metal base code 764 - Base: Powder coated RAL 9004 matte. / Mim top code 758, Ø70 cm - Top: Dekton Sirius. Oak solid wood edge, varnished natural EM.

Naoshima stool code 702 / Legs: beech solid wood dyied White 13 EM
/ Seat: beech veneer dyied White 13 EM.



Naoshima Collection

Naoshima Collection

– by Emiliana
Design Studio

La colección de taburetes Naoshima diseñada por Emiliana Design Studio experimenta con el potencial expresivo y estructural de la madera curvada. La sinuosa silueta del asiento, virtuosamente ensamblado, nos sugiere un juego visual entre la materia y el vacío.



P.78 P.79 Naoshima stool code 702 / Legs: oak solid wood varnished natural EM / Seat: oak veneer laquered RAL 9004 PO EM.

The Naoshima stool collection designed by Emiliana Design Studio plays with the expressive and structural potential of curved wood. The virtuously assembled meandering silhouette of the seat suggests visual play between matter and nothingness.



Naoshima stool code 702 / Legs: beech solid wood dyied White 13 EM
/ Seat: beech veneer dyied White 13 EM.



Naoshima Collection



P.82 Naoshima stool code 703 / Legs: oak solid wood lacquered RAL 6006 PO AN
/ Seat: oak veneer lacquered RAL 6006 PO AN.
P.83 Naoshima stool code 703 / Legs: oak solid wood varnished natural EM
/ Seat: oak veneer varnished natural EM.



1. Naoshima stool code 703 / Legs: oak solid wood lacquered RAL 1027 PO AN
/ Seat: oak veneer lacquered RAL 1027 PO AN.
2. Naoshima stool code 702 / Legs: beech solid wood dyied White 13 EM
/ Seat: beech veneer dyied White 13 EM.
3. Naoshima stool code 701 / Legs: oak solid wood lacquered RAL 9004 PO EM
/ Seat: oak veneer lacquered RAL 9004 PO EM.
4. Naoshima stool code 702 / Legs: oak solid wood varnished natural EM
/ Seat: oak veneer laquered RAL 9004 PO EM.
5. Naoshima stool code 703 / Legs: oak solid wood varnished natural EM
/ Seat: oak veneer varnished natural EM.



Disponibile en tres alturas diferentes, el taburete combina cuatro piezas idénticas para construir el asiento, la prolongación del cual conecta con patas de madera maciza creando un conjunto sólido y estable.

+ Info P.110

Available in three different heights, the stool joins four identical pieces to create the seat, the extension of which connects to solid wood legs, creating a strong and stable result.

+ Info P.110



Naoshima Collection



P.86 Naoshima stool code 702 / Legs: beech solid wood dyied White 13 EM
/ Seat: beech veneer dyied White 13 EM.

P.87 Naoshima stool code 703 / Legs: oak solid wood lacquered RAL 1027 PO AN
/ Seat: oak veneer lacquered RAL 1027 PO AN.

1. Naoshima stool code 703 / Legs: oak solid wood varnished natural EM
/ Seat: oak veneer varnished natural EM.
2. Naoshima stool code 703 / Legs: oak solid wood lacquered RAL 1027 PO AN
/ Seat: oak veneer lacquered RAL 1027 PO AN.
3. Naoshima stool code 703 / Legs: oak solid wood lacquered RAL 6006 PO AN
/ Seat: oak veneer lacquered RAL 6006 PO AN.



1

2

3

Product information

"Cuando Esteve y Joan Vergés nos pidieron asumir la dirección de arte de esta nueva etapa, tuvimos claro que el territorio donde se encuentra Vergés sería una sugerente fuente de inspiración. En la Garrotxa, una zona de origen volcánico en el que abundan bosques y hayedos, los cambios de estación son muy perceptibles en el entorno natural, toda esta riqueza de tonalidades y matices han sido sin duda un gran referente a la hora de seleccionar los colores y acabados para la colección de Vergés 2019/2020."

Ana Mir, emiliana design studio

'When Esteve and Joan asked to take over art direction for this new phase, we knew the land surrounding the Vergés' facilities would be an enticing source of inspiration. In Garrotxa, an area with volcanic origins where forests and beech trees flourish, seasonal changes in the natural landscape are highly noticeable. No doubt, those rich tonalities and nuances have served as a reference for selecting the colours and finishes of the 2019/2020 Vergés collection.'

Ana Mir, emiliana design studio

ABC Collection by Lázaro Rosa Violán

Modelos / Models

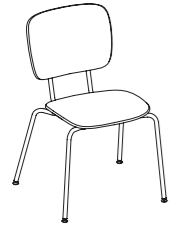

970



971



972



973

Respaldo y asiento / Backrest & seat

Contrachapado de haya o fresno acabados madera natural, haya tintada y fresno lacado./ Beech or Ash Plywood Finishes in natural wood, dye beech and lacquered ash.

Estructura / Frame Patas acero / Metal legs

Tubo de acero pintado en polvo con colores RAL./ Steel tube finished powder - coated with RAL colors.

Tapizado / Upholstery

Tapizado de asiento, o en el conjunto de asiento y respaldo./ Upholstered seat or upholstered seat and backrest.

Peso / Weight

5.1 kg/u

Volumen caja / Volumetric Packaging

2 u. 58 x 68 x 89 cm

Apilable* / Stackable*

Hasta 5 u / Up to 5 u
*Excepto con tapizado./
*Except with upholstery.

Respaldo y asiento / Backrest & seat

Contrachapado de haya o fresno acabados madera natural, haya tintada y fresno lacado./ Beech or Ash Plywood Finishes in natural wood, dye beech and lacquered ash.

Estructura / Frame Patas acero / Metal legs

Tubo de acero pintado en polvo con colores RAL./ Steel tube finished powder - coated with RAL colors.

Tapizado / Upholstery

Tapizado de asiento, o en el conjunto de asiento y respaldo./ Upholstered seat or upholstered seat and backrest.

Peso / Weight

5.1 kg/u

Volumen caja / Volumetric Packaging

2 u. 58 x 68 x 89 cm

Apilable* / Stackable*

Hasta 5 u / Up to 5 u
*Excepto con tapizado./
*Except with upholstery.

Respaldo y asiento / Backrest & seat

Contrachapado de haya o fresno acabados madera natural, haya tintada y fresno lacado./ Beech or Ash Plywood Finishes in natural wood, dye beech and lacquered ash.

Estructura / Frame

Tubo de acero pintado en polvo con colores RAL./ Steel tube finished powder - coated with RAL colors.

Patatas madera / Wooden Legs

Patatas de madera maciza de haya o fresno./ Beech or ash solid wood legs.

Tapizado / Upholstery

Tapizado de asiento, o en el conjunto de asiento y respaldo./ Upholstered seat or upholstered seat and backrest.

Peso / Weight

7 kg/u

Volumen caja / Volumetric Packaging

2 u. 49x 59 x 97 cm

Respaldo y asiento / Backrest & seat

Contrachapado de haya o fresno acabados madera natural, haya tintada y fresno lacado./ Beech or Ash Plywood Finishes in natural wood, dye beech and lacquered ash.

Estructura / Frame

Tubo de acero pintado en polvo con colores RAL./ Steel tube finished powder - coated with RAL colors.

Patatas madera / Wooden Legs

Patatas de madera maciza de haya o fresno./ Beech or ash solid wood legs.

Tapizado / Upholstery

Tapizado de asiento, o en el conjunto de asiento y respaldo./ Upholstered seat or upholstered seat and backrest.

Peso / Weight

9.8 kg/u

Volumen caja / Volumetric Packaging

1 u. 55x 55 x 90 cm

Medidas / Dimensions

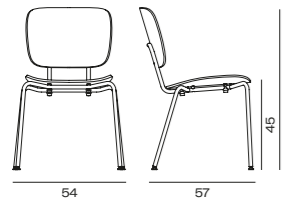

54

57

45

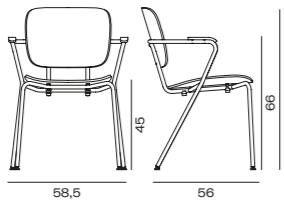

58,5

56

45

81

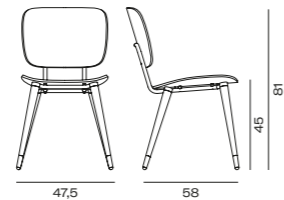

47,5

58

45

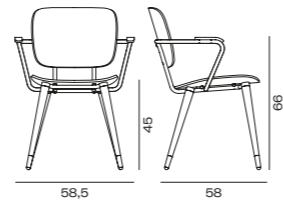

58,5

58

45

81

Respaldo y asiento / Backrest & seat

Madera contrachapada / Veneer plywood.



Haya natural / Natural beech



Haya / Beech White 93



Haya / Beech Grey 79



Fresno natural / Natural ash



Fresno / Ash 7044 PO



Fresno / Ash 1027 PO



Fresno / Ash 3011 PO



Fresno / Ash 6006 PO



Fresno / Ash 5004 PO

Patatas madera / Wooden Legs

Madera maciza / Solid Wood.

Estructura / Frame

Tubo de acero pintado en polvo con colores RAL./ Steel tube finished powder - coated with RAL colors.



RAL 7044



RAL 7039



RAL 1000



RAL 1027



RAL 3011



RAL 6013



RAL 6006



RAL 5004

Acabados metálicos./ Metal finishes.



Niquelado brillo / Nickel-plated shine



Niquelado mate / Nickel-plated matt



Niquelado negro brillante/ Bright blacknickel-plated

Tapizado / Upholstery

Textiles (lana) / Fabrics (wool), Gabriel - Note & Harmony.



Note 60005



Note 61147



Note 68156



Note 62041



Note 63036



Note 66144



Note 60051



Harmony 5101

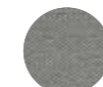

Harmony 3101



Harmony 2102



Harmony 1113



Harmony 4104



Harmony 2103



Harmony 3102



Harmony 1101



Harmony 1111



Harmony 1104

Todos los acabados que se muestran a continuación forman parte de una elaborada selección. Para ver carta completa de acabados dirigirse a pág. 112./ All finishes shown below are part of an elaborate color palette. To see the complete catalogue of finishes see page 112.

Certificados / Certificates

Modelos / Models 971 - 972. EN 1728:2012 + AC:2013.

ABC Collection by Lázaro Rosa Violán

Modelos / Models



974

Base metálica / Metal base

3 patas con niveladores ajustables. Tubo de acero pintado con pintura en polvo poliéster en colores RAL. Sobre máximo aconsejado de Ø 70 cm. Con articulación abatible./ 3 steel legs with adjustable leveling feet. polyester powder coating in RAL colors. Top recommended maximum of Ø 70 cm. With folding top pivot.

Peso / Weight
7 kg/u

Volumen caja / Volumetric Packaging
1 u. 62 x 54 x 75 cm



975

Base metálica / Metal base

4 patas con niveladores ajustables. Tubo de acero pintado con pintura en polvo poliéster en colores RAL. Sobre máximo aconsejado de 80 x 80 cm. Con articulación abatible./ 4 steel legs with adjustable leveling feet. polyester powder coating in RAL colors. Top recommended maximum of 80 x 80 cm. With folding top pivot.

Peso / Weight
7.5 kg/u

Volumen caja / Volumetric Packaging
1 u. 52 x 52 x 75 cm

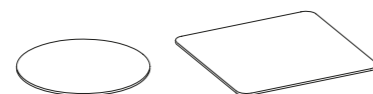

977

Sobre / Top

MDF chapado de madera de haya, fresno o laminado de Formica. Acabados disponibles en madera natural, tinte o laca./ MDF veneered with beech veneer, ash veneer or Formica laminated. Finishes are available in natural wood, dye or lacquer.

Peso / Weight
Segun medidas y acabados./ Depending on size & finish.

Volumen caja / Volumetric Packaging
Redonda / Round:
2 u. 75 x 75 x 15 cm
Cuadrada / Squared:
2 u. 85 x 85 x 30 cm

Sobre madera / Wooden top

Madera contrachapada de haya y fresno./ Beech and ash plywood.



Haya natural / Natural beech



Haya / Beech White 93



Haya / Beech Grey 79



Fresno natural / Natural ash



Fresno / Ash 7044 PO



Fresno / Ash 1027 PO



Fresno / Ash 3011 PO



Fresno / Ash 6006 PO



Fresno / Ash 5004 PO

Sobre Formica / Formica top

Laminado HPL./ HPL laminate.



Infiniti F7858



Infiniti F7923



Infiniti F7927



Infiniti F7961



Infiniti F4161



Infiniti F7966



Infiniti F2297



Infiniti F2253

Base metálica / Metal base

Tubo de acero pintado en polvo con colores RAL./ Steel tube finished powder - coated with RAL colors.



RAL 7044



RAL 7039



RAL 1000



RAL 1027



RAL 3011



RAL 6013



RAL 6006



RAL 5004

Tubo de acero en acabados metálicos./ Steel tube in metallic finishes.



Niquelado brillo / Nickel-plated shine



Niquelado mate / Nickel-plated matt



Niquelado negro brillante / Bright blacknickel-plated

Medidas / Dimensions

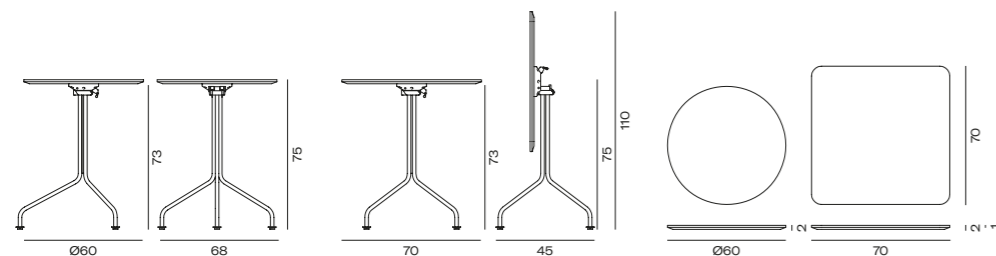

Bernardes Collection by Andreu Carulla

Modelos / Models



290

Estructura / Frame

Asiento, respaldo y patas de madera maciza de haya. Interior del respaldo con rejilla de rattan./ Seat, backrest and legs in solid beech wood. Inside of backrest with rattan mesh.

Tapizado / Upholstery
Tapizado disponible para el asiento./ Upholstery available in seat.

Peso / Weight
8,5 kg/u

Volumen caja / Volumetric Packaging
2 u. 49 x 65 x 113 cm

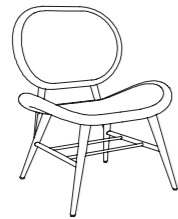

293

Estructura / Frame

Asiento, respaldo y patas de madera maciza de haya. Interior del respaldo con rejilla de rattan./ Seat, backrest and legs in solid beech wood. Inside of backrest with rattan mesh.

Tapizado / Upholstery
Tapizado disponible para el asiento./ Upholstery available in seat.

Peso / Weight
9 kg/u

Volumen caja / Volumetric Packaging
1 u. 58 x 68 x 89 cm

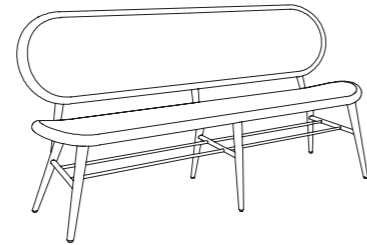

292

Estructura / Frame

Asiento, respaldo y patas de madera maciza de haya. Interior del respaldo con rejilla de rattan./ Seat, backrest and legs in solid beech wood. Inside of backrest with rattan mesh.

Tapizado / Upholstery
Tapizado disponible para el asiento./ Upholstery available in seat.

Peso / Weight
15 kg/u

Volumen caja / Volumetric Packaging
1 u. 158 x 58 x 90 cm

Premios / Awards



Silver Delta
ADI Awards
2016

Medidas / Dimensions

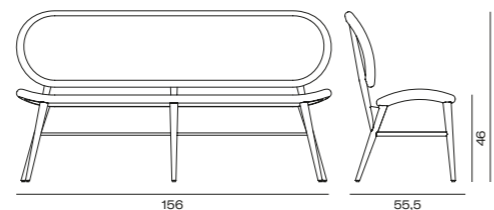
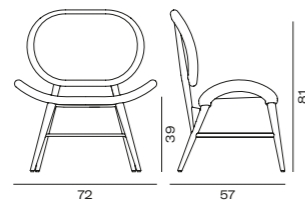
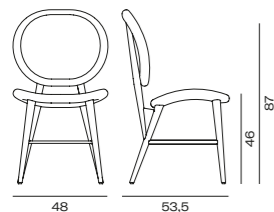

Estructura / Frame

Madera maciza de haya./ Solid beech wood.



Haya natural
/ Natural beech



White
13



Grey
74



Pink
32



Red
31



Blue
54



Black
94

Malla rattan / Cane mesh

Malla natural o tintada (celulosa)./ Natural mesh or dye (cellulose).

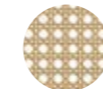

Rattan natural
/ Natural cane



White
13



Grey
74

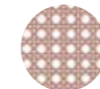

Pink
32

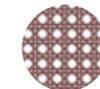

Red
31

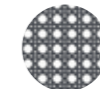

Blue
54

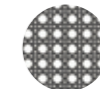

Black
94

Tapizado / Upholstery

Textiles (lana) / Fabrics (wool), Gabriel – Mood. Piel Vegana (PV) / Vegan leather, Spradling – Dolce. Piel Natural / Natural leather, Penelopeoggi – Nuvola Pesca.



Mood
1105

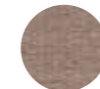

Mood
1103



Mood
3101



Mood
1106



Mood
5101



Mood
2101



Dolce
Artesian



Dolce
Bramble



Dolce
Indigo



P0151
Pesca

Todos los acabados que se muestran a continuación forman parte de una elaborada selección. Para ver carta completa de acabados dirigirse a pág. 112./ All finishes shown below are part of an elaborate color palette. To see the complete catalogue of finishes see page 112.

Certificados / Certificates

Modelo / Model 290. EN 1728:2012 + AC:2013.

Glöwr Collection by Claire Davies

Modelos / Models



780

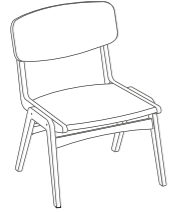

781



782

Respaldo y asiento / Backrest & seat

Contrachapado de haya.
Disponible en madera
natural o tintada./
Plywood beech. Available
in natural wood or dye.

Patas madera / Wooden legs

Madera maciza de haya
acabados natural o tinte.
Fijación lateral con
tornillos de latón./ Solid
beech wood. Available in
natural wood, dye or
lacquer. Lateral fixation
with brass screws.

Tapizado / Upholstery

Tapizado de asiento, o
en el conjunto de asiento
y respaldo./ Upholstered
seat or upholstered seat
and backrest.

Peso / Weight

5 kg/u

Volumen caja / Volumetric Packaging

2 u. 49 x 59 x 97 cm

Apilable / Stackable

Hasta 5 u / Up to 5 u

Respaldo y asiento / Backrest & seat

Contrachapado de haya.
Disponible en madera
natural o tintada./
Plywood beech. Available
in natural wood or dye.

Patas madera / Wooden legs

Madera maciza de haya
acabados natural o tinte.
Fijación lateral con
tornillos de latón./ Solid
beech wood. Available in
natural wood, dye or
lacquer. Lateral fixation
with brass screws.

Tapizado / Upholstery

Tapizado de asiento, o
en el conjunto de asiento
y respaldo./ Upholstered
seat or upholstered seat
and backrest.

Peso / Weight

7.5 kg/u

Volumen caja / Volumetric Packaging

2 u. 58 x 68 x 89 cm

Apilable / Stackable

Hasta 5 u / Up to 5 u

Respaldo y asiento / Backrest & seat

Contrachapado de haya.
Disponible en madera
natural o tintada./
Plywood beech. Available
in natural wood or dye.

Patas madera / Wooden legs

Madera maciza de haya
acabados natural o tinte.
Fijación lateral con
tornillos. Reposapiés
metálico acabado en
latón./ Solid beech wood.
Available in natural wood,
dye or lacquer. Lateral
fixation with brass
screws. Metallic footrest
finished in brass.

Tapizado / Upholstery

Tapizado de asiento, o
en el conjunto de asiento
y respaldo./ Upholstered
seat or upholstered seat
and backrest.

Peso / Weight

6 kg/u

Volumen caja / Volumetric Packaging

1 u. 45 x 52 x 115 cm

Medidas / Dimensions

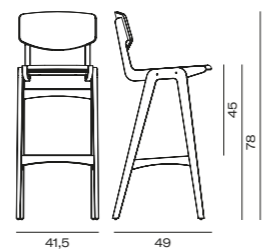
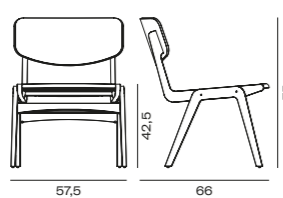
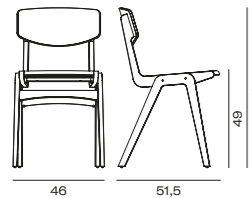

Respaldo y asiento / Backrest & seat Madera contrachapada./ Veneer plywood.

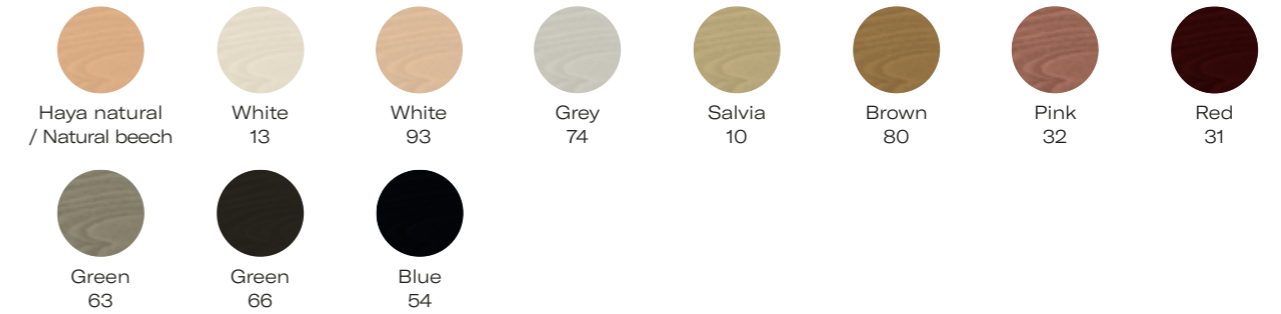

Patas madera / Wooden legs Madera maciza./ Solid Wood.

Tapizado / Upholstery

Textiles (poliéster y lana) / Fabrics (polyester & wool), Gabriel – Go Uni & Fame.
Piel Vegana (PV) / Vegan leather, Spradling – Dolce. Piel Natural / Natural leather, Penelopeggi – Nuvola Pesca.

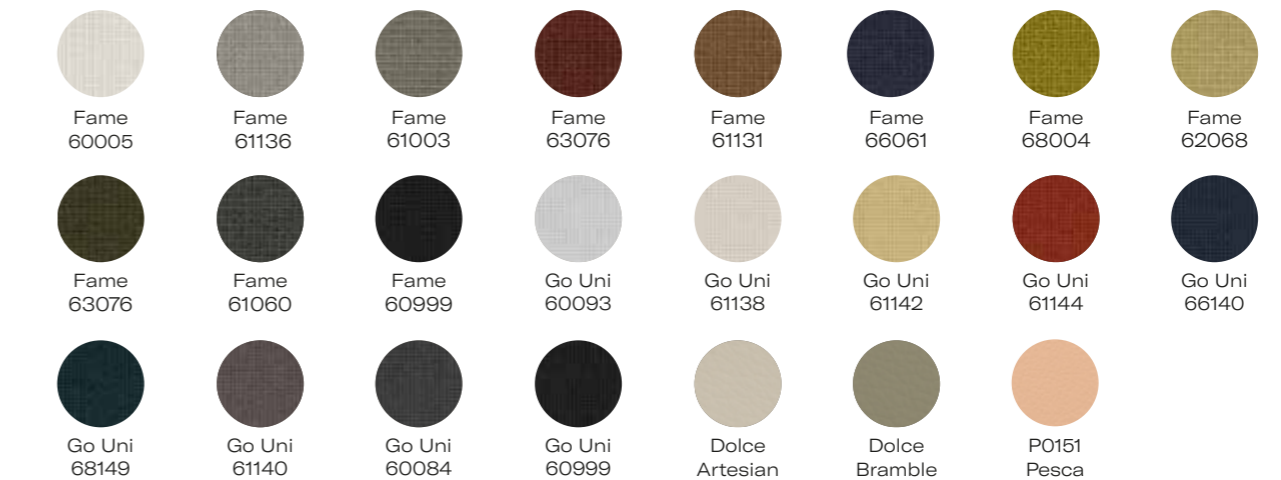

Todos los acabados que se muestran a continuación forman parte de una elaborada selección. Para ver carta completa de acabados dirigirse a pág. 112./ All finishes shown below are part of an elaborate color palette. To see the complete catalogue of finishes see page 112.

Certificados /Certificates

Modelos / Models 780 – 782. EN 1728:2012 + AC:2013.

Glöwr Collection by Claire Davies

Modelos / Models

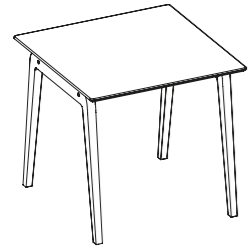

783

Sobre / Top

Contrachapado de haya.
Disponible en madera
natural, tinte o Formica./
Plywood beech.
Available in natural wood,
dye or Formica.

Base madera / Wooden base

Madera maciza de haya
acabados natural o tinte.
Fijación lateral con
tornillos de latón./ Solid
beech wood finished
natural or dye. Lateral
fixation with brass
screws.

Peso / Weight

16.5 kg/u

Volumen caja /

Volumetric Packaging

1 u. 82 x 82 x 80 cm

Medidas / Dimensions

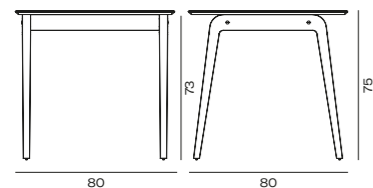

Sobre madera / Wooden Top

Rechapado de madera./ Wooden veneer.

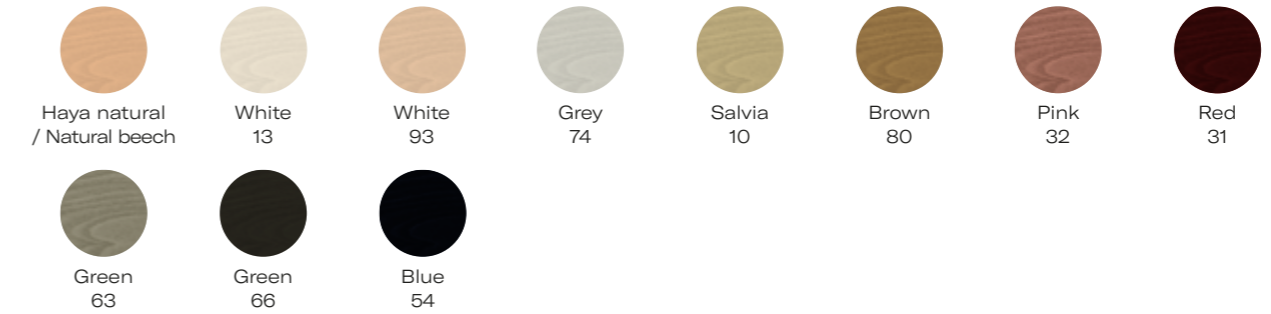

Sobre Formica / Formica top

Laminado HPL./ HPL laminate.

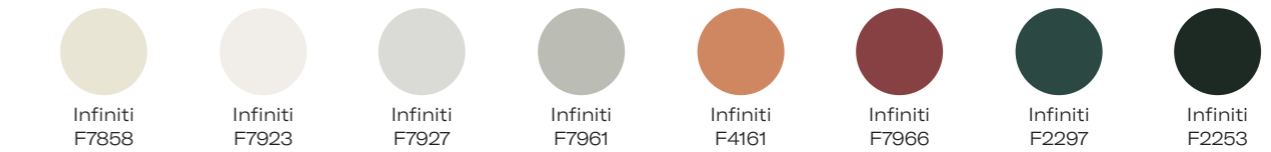

Estructura madera / Wooden frame

Madera maciza de haya./ Solid beech wood.

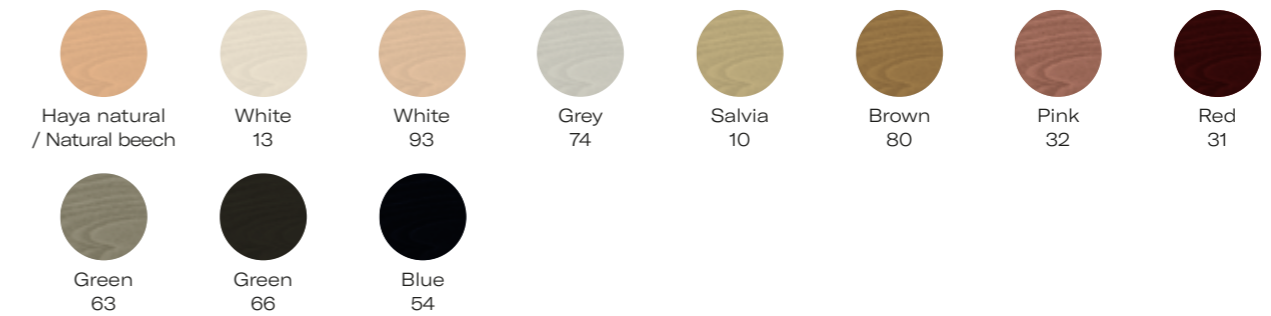

Kimmi Collection by Roger Vancells

Modelos / Models



253

Respaldo y asiento / Backrest & seat

Contrachapado de fresno acabado madera natural o lacado y contrachapado de haya acabado madera natural o tintado./ Lacquered or natural ash and tinted or natural beech plywood.

Estructura / Frame
Patatas acero / Metal legs
Tubo de acero pintado en polvo con colores RAL./ Steel tube finished powder - coated with RAL colors.

Tapizado / Upholstery
Tapizado disponible en asiento./ Upholstery available in seat.

Peso / Weight
5 kg/u

**Volumen caja /
Volumetric Packaging**
1 u. 49 x 59 x 97 cm



254

Respaldo y asiento / Backrest & seat

Contrachapado de fresno acabado madera natural o lacado y contrachapado de haya acabado madera natural o tintado./ Lacquered or natural ash and tinted or natural beech plywood.

Estructura / Frame
Patatas acero / Metal legs
Varilla de acero pintado en polvo con colores RAL. Pata tipo patin con deslizantes./ Steel rod finished powder - coated with RAL colors. Sled steel base.

Tapizado / Upholstery
Tapizado disponible en asiento./ Upholstery available in seat.

Peso / Weight
7 kg/u

**Volumen caja /
Volumetric Packaging**
1 u. 49 x 59 x 97 cm



255

Respaldo y asiento / Backrest & seat

Contrachapado de fresno acabado madera natural o lacado y contrachapado de haya acabado madera natural o tintado./ Lacquered or natural ash and tinted or natural beech plywood.

Estructura / Frame
Patatas acero / Metal legs
Tubo de acero pintado en polvo con colores RAL. Pata tipo araña giratoria con reguladores./ Steel tube finished powder - coated with RAL colors. Swivel central base.

Tapizado / Upholstery
Tapizado disponible en asiento./ Upholstery available in seat.

Peso / Weight
10 kg/u

**Volumen caja /
Volumetric Packaging**
1 u. 49 x 59 x 97 cm



256

Respaldo y asiento / Backrest & seat

Contrachapado de fresno acabado madera natural o lacado y contrachapado de haya acabado madera natural o tintado./ Lacquered or natural ash and tinted or natural beech plywood.

Estructura / Frame
Marco de acero pintado en polvo con colores RAL./ Steel frame finished powder - coated with RAL colors.

**Patatas madera /
Wooden legs**
Patatas de madera maciza de haya o fresno./ Beech or ash solid wood legs.

Tapizado / Upholstery
Tapizado disponible en asiento./ Upholstery available in seat.

Peso / Weight
6.5 kg/u

**Volumen caja /
Volumetric Packaging**
1 u. 49 x 59 x 97 cm

Respaldo y asiento / Backrest & seat

Madera contrachapada./ Veneer plywood.



Fresno Natural / Natural Ash



Fresno / Ash 7044 PO



Fresno / Ash 7039 PO



Fresno / Ash 1027 PO



Fresno / Ash 3012 PO



Fresno / Ash 6006 PO



Fresno / Ash 5004 PO



Fresno / Ash 9004 PO



Haya / Beech White 93



Haya / Beech Grey 79

Patatas madera / Wooden legs

Madera maciza./ Solid Wood.

Estructura / Frame

Acero pintado en polvo con colores RAL./ Steel finished powder - coated with RAL colors.



Niquelado brillo / Nickel-plated shine



RAL 9003



RAL 7044



RAL 1027



RAL 3012



RAL 6006



RAL 5004



RAL 9004

Tapizado / Upholstery

Textiles (poliéster) / Fabrics (polyester), Gabriel - Atlantic. Piel Vegana (PV) / Vegan leather, Spradling - Dolce.



Atlantic 60011



Atlantic 60025

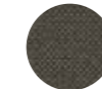

Atlantic 61163



Atlantic 61078



Atlantic 61164



Atlantic 60999



Dolce Dune



Dolce Fog



Dolce Moss

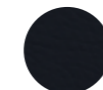

Dolce Indigo

Medidas / Dimensions

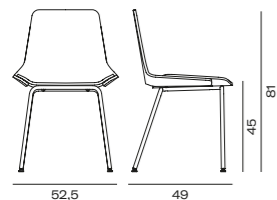

52,5 49 45 81

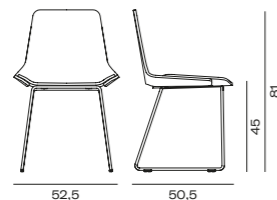

52,5 50,5 45 81

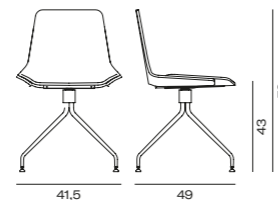

41,5 49 43 79

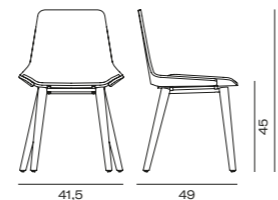

41,5 49 45 81

Todos los acabados que se muestran a continuación forman parte de una elaborada selección. Para ver carta completa de acabados dirigirse a pág. 112./ All finishes shown below are part of an elaborate color palette. To see the complete catalogue of finishes see page 112.

Certificados / Certificates

Modelo / Model 254. EN 1728:2012 + AC:2013

Kimmi Collection by Roger Vancells

Modelos / Models



257

Estructura y Marco del sobre / Structure & Top's frame

Base tubular en acero pintado con pintura en polvo poliéster en colores RAL. Sobre máximo aconsejado de Ø 60 cm./ Tubular base steel polyester powder coating in RAL colors. Top recommended maximum of Ø 60 cm.

Peso / Weight
5.5 kg/u

Volumen caja / Volumetric Packaging
1 u. 45 x 45 x 55 cm



258

Estructura y Marco del sobre / Structure & Top's frame

Base tubular en acero pintado con pintura en polvo poliéster en colores RAL. Sobre máximo aconsejado de Ø 70 cm./ Tubular base steel polyester powder coating in RAL colors. Top recommended maximum of Ø 70 cm.

Peso / Weight
8 kg/u

Volumen caja / Volumetric Packaging
1 u. 45 x 45 x 75 cm

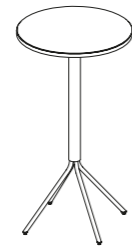

259

Estructura y Marco del sobre / Structure & Top's frame

Base tubular en acero pintado con pintura en polvo poliéster en colores RAL. Sobre máximo aconsejado de Ø 50 cm./ Tubular base steel polyester powder coating in RAL colors. Top recommended maximum of Ø 50 cm.

Peso / Weight
8 kg/u

Volumen caja / Volumetric Packaging
1 u. 45 x 45 x 110 cm



260

Sobre / Top

Ø 50 – 60 – 70 cm. MDF chapados en fresno lacado, haya tintada o laminados, o mineral de Dekton, Formica o Silestone./ MDF plated lacquered ash, dyed beech or plateds, Formica laminated or mineral Dekton, Formica or Silestone.

Marco del sobre / Top's frame

Marco de acero cromado o pintado al polvo con colores RAL./ Top's frame steel chromed or powder coated steel with RAL colors.

Peso / Weight
Segun medidas y acabados./ Depending on size & finish.

Medidas / Dimensions

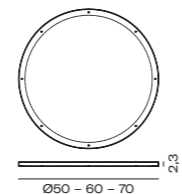
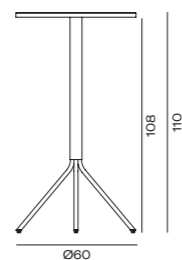
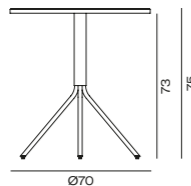
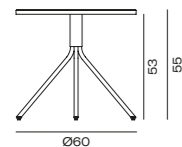

Product information

Sobre madera / Wooden top

Rechapado de madera./ Wooden veneer.



Fresno Natural / Natural Ash



Fresno / Ash 7044 PO



Fresno / Ash 7039 PO



Fresno / Ash 1027 PO



Fresno / Ash 3012 PO



Fresno / Ash 6006 PO



Fresno / Ash 5004 PO



Fresno / Ash 9004 PO



Haya / Beech White 93



Haya / Beech Grey 79

Sobre Dekton / Dekton top



Zenith



Edora



Ventus



Galema



Kandum



Sirius

Sobre Silestone / Silestone top



Iconic white



Haiku



Desert silver



Cemento spa



Unsui



Soapstone

Sobre Formica / Formica top

Laminado HPL./ HPL laminate.



Infiniti F7858



Infiniti F7923



Infiniti F7927



Infiniti F7961



Infiniti F4161



Infiniti F7966



Infiniti F2297



Infiniti F2253

Marco y base metálica / Metal frame & base

Acero pintado en polvo con colores RAL./ Steel finished powder - coated with RAL colors.



RAL 9003



RAL 7044



RAL 1027



RAL 3012



RAL 6006



RAL 5004



RAL 9004

Acero en acabados metálicos./ Steel metal finishes.



Niquelado brillo / Nickel-plated shine



Niquelado mate / Nickel-plated matt



Niquelado negro brillante / Bright blacknickel-plated

Mim Collection by Tarruella Trenchs Studio

Modelos / Models

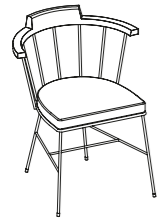

754

Respaldo / Backrest

Respaldo de madera maciza de haya tintada o lacada, nogal natural y roble natural./ Dye or lacquered beech, natural walnut and oak solid wood backrest.

Estructura / Frame

Estructura de varilla maciza de acero pintado en polvo con colores RAL./ Solid frame of steel finished powder - coated with RAL colors.

Tapizado / Upholstery

Asiento acolchado tapizado./ Upholstered cushioned seat.

Peso / Weight

7 kg/u

Volumen caja / Volumetric Packaging

1 u. 58 x 68 x 89 cm



755

Respaldo / Backrest

Respaldo de madera maciza de haya tintada o lacada, nogal natural y roble natural./ Dye or lacquered beech, natural walnut and oak solid wood backrest.

Estructura / Frame

Estructura de varilla maciza de acero pintado en polvo con colores RAL./ Solid frame of steel finished powder - coated with RAL colors.

Tapizado / Upholstery

Asiento acolchado tapizado./ Upholstered cushioned seat.

Peso / Weight

9.5 kg/u

Volumen caja / Volumetric Packaging

1 u. 49 x 59 x 97 cm



756

Respaldo / Backrest

Respaldo de madera maciza de haya tintada o lacada, nogal natural y roble natural./ Dye or lacquered beech, natural walnut and oak solid wood backrest.

Estructura / Frame

Estructura de varilla maciza de acero pintado en polvo con colores RAL./ Solid frame of steel finished powder - coated with RAL colors.

Tapizado / Upholstery

Asiento acolchado tapizado./ Upholstered cushioned seat.

Peso / Weight

8.5 kg/u

Volumen caja / Volumetric Packaging

1 u. 49 x 59 x 97 cm

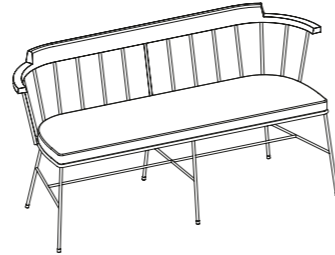

757

Respaldo / Backrest

Respaldo de madera maciza de haya tintada o lacada, nogal natural y roble natural./ Dye or lacquered beech, natural walnut and oak solid wood backrest.

Estructura / Frame

Estructura de varilla maciza de acero pintado en polvo con colores RAL./ Solid frame of steel finished powder - coated with RAL colors.

Tapizado / Upholstery

Asiento acolchado tapizado. Este modelo cuenta con cojines (opcionales) con la misma tapicería./ Upholstered cushioned seat. This model has (optional) pillows with the same upholstery.

Peso / Weight

20 kg/u

Volumen caja / Volumetric Packaging

1 u. 152 x 60 x 75 cm

Respaldo / Backrest

Madera maciza./ Solid wood.



Haya / Beech
White 93



Haya / Beech
Grey 74



Haya / Beech
Grey 79



Haya / Beech
Green 66



Haya / Beech
RAL 8023



Haya / Beech
RAL 5004



Nogal natural
/ Natural walnut



Roble natural
/ Natural oak

Estructura / Frame

Barra de acero pintado en polvo con colores RAL./ Steel finished powder - coated with RAL colors.



RAL
1013



RAL
9004



RAL
7044



RAL
7039



RAL
1000



RAL
8023



RAL
6013



RAL
6006



RAL
5004

Patas acero / Metal legs

Tapizado / Upholstery

Textiles (Trevira cs) / Fabrics (Trevira cs), Gabriel - Go Check. Textiles (PP-PES) / Fabrics (PP-PES), Crevin - Dolce.

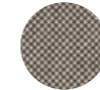

Go Check
61138

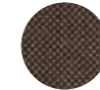

Go Check
61139



Go Check
61140



Go Check
60084



Go Check
60080

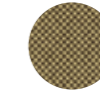

Go Check
61142



Go Check
61144



Go Check
66140



Dolce
07 Inout

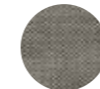

Dolce
75 Inout



Dolce
83 Inout

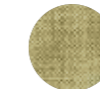

Dolce
32 Inout



Dolce
24 Inout



Dolce
30 Inout

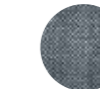

Dolce
43 Inout



Dolce
53 Inout

Medidas / Dimensions

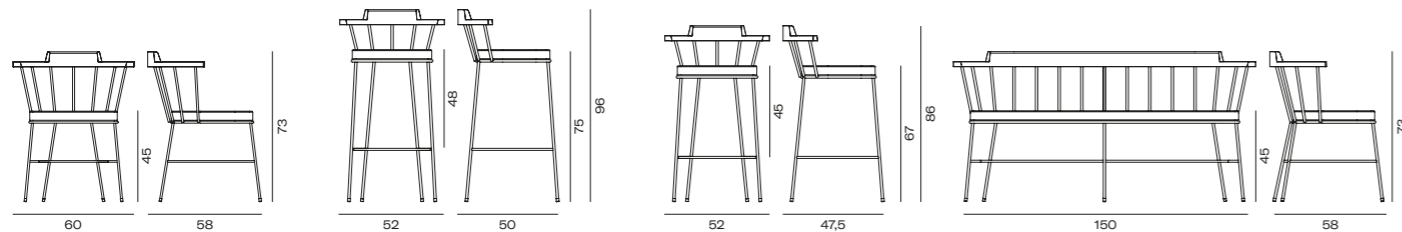

Mim Collection by Tarruella Trenchs Studio

Modelos / Models

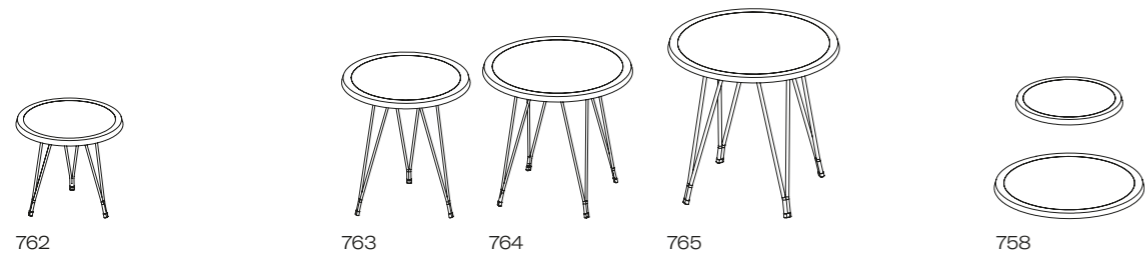

Sobre / Top
Ø 40 – 50 cm.

Estructura / Frame
3 patas. Varilla metálica, pintada con pintura en polvo poliéster en colores RAL./ 3 legs. Metal rod Ø 10 mm, polyester powder coating in RAL colors.

Peso / Weight
3 kg/u – Estructura / Frame

Volumen caja / Volumetric Packaging
1 u. 35 x 40 x 45 cm

Sobre / Top
763. Ø 50 – 60 cm.
764. Ø 60 – 70 cm.

Estructura / Frame
3 – 4 patas. Varilla metálica, pintada con pintura en polvo poliéster en colores RAL./ 3 – 4 legs. Metal rod Ø 10 mm, polyester powder coating in RAL colors.

Peso / Weight
763. 4.5 kg/u
764. 7 kg/u
Estructura / Frame

Volumen caja / Volumetric Packaging
763. 1 u. 42 x 48 x 65 cm
764. 1 u. 48 x 48 x 65 cm

Sobre / Top
Ø 70 – 80 cm.

Estructura / Frame
4 patas. Tubo metálico, pintada con pintura en polvo poliéster en colores RAL./ 4 legs. Metal tube Ø 16 x 2mm, polyester powder coating in RAL colors.

Peso / Weight
9 kg/u – Estructura / Frame

Volumen caja / Volumetric Packaging
1 u. 57 x 57 x 75 cm

Sobre / Top
Mineral de Dekton, Silestone o laminado de Formica emmarcado en madera maciza de haya natural, tintada o lacada, roble natural y nogal natural./ Dekton, silestone mineral top or laminated Formica top in natural, dyed or lacquered beech solid wood, natural oak & natural walnut solid wood.

Peso / Weight
Segun medidas y acabados./ Depending on size & finish.

Medidas / Dimensions

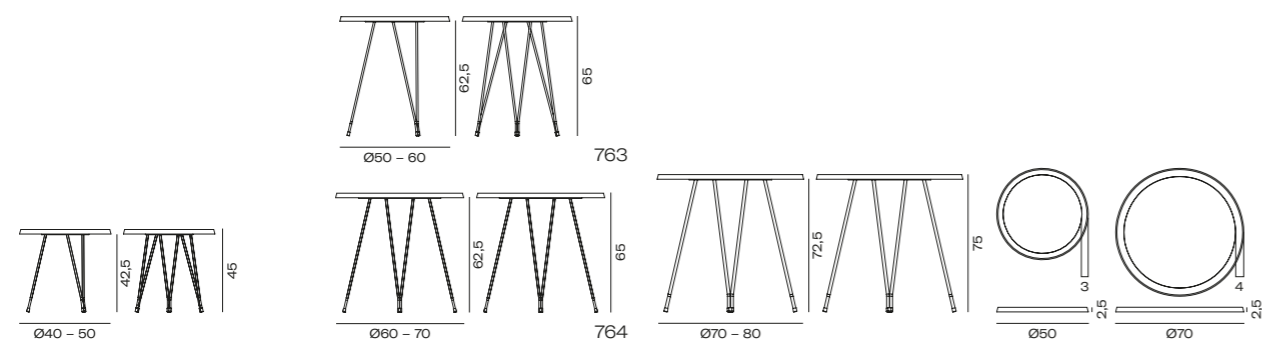

Product information

Marco del sobre / Top frame

Madera de haya, de roble y de nogal natural./ Natural beech, oak and walnut wood.



Haya / Beech White 93 Roble natural / Natural oak Nogal natural / Natural walnut

Interior del sobre / Top interior

Interior del sobre / Top interior

Acabado en madera de haya, nogal y roble./ Wooden finishes in beech, walnut or oak.



Haya / Beech White 93 Haya / Beech Grey 74 Haya / Beech Grey 79 Haya / Beech Green 66 Haya / Beech RAL 8023 Haya / Beech RAL 5004

Sobre Dekton / Dekton top



Zenith Edora Ventus Galema Kandum Sirius

Sobre Silestone / Silestone top



Iconic white Haiku Desert silver Cemento spa Unsui Soapstone

Sobre Formica / Formica top

Laminado HPL./ HPL laminate.



Infiniti F7858 Infiniti F7923 Infiniti F7927 Infiniti F7961 Infiniti F4161 Infiniti F7966 Infiniti F2297 Infiniti F2253

Estructura / Frame

Acero lacado./ Lacquered steel.



RAL 1013 RAL 9003 RAL 7044 RAL 7030 RAL 7039 RAL 1000 RAL 8000 RAL 1027



RAL 8023 RAL 3012 RAL 3016 RAL 3011 RAL 6013 RAL 6006 RAL 5004 RAL 9004

Naoshima Collection by Emiliana Design

Modelos / Models

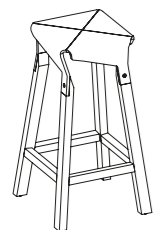

701

Asiento / Seat

Contrachapado de haya o roble, acabado madera natural, laca o tinte./ Beech or oak plywood, natural wood finish, lacquer or dye.

Patas / Legs

Madera maciza de haya natural o tintada y madera maciza de roble natural o lacada./ Natural or dye beech solid wood & natural or lacquered oak solid wood.

Peso / Weight

5 kg/u

Volumen caja / Volumetric Packaging

1 u. 42 x 42 x 87 cm

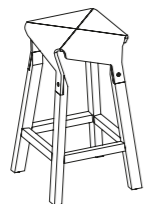

702

Asiento / Seat

Contrachapado de haya o roble, acabado madera natural, laca o tinte./ Beech or oak plywood, natural wood finish, lacquer or dye.

Patas / Legs

Madera maciza de haya natural o tintada y madera maciza de roble natural o lacada./ Natural or dye beech solid wood & natural or lacquered oak solid wood.

Peso / Weight

4 kg/u

Volumen caja / Volumetric Packaging

1 u. 42 x 42 x 87 cm



703

Asiento / Seat

Contrachapado de haya o roble, acabado madera natural, laca o tinte./ Beech or oak plywood, natural wood finish, lacquer or dye.

Patas / Legs

Madera maciza de haya natural o tintada y madera maciza de roble natural o lacada./ Natural or dye beech solid wood & natural or lacquered oak solid wood.

Peso / Weight

3.5 kg/u

Volumen caja / Volumetric Packaging

2 u. 42 x 42 x 87 cm

Premios / Awards



reddot award 2016
winner

Desde 2018, Naoshima stool forma parte del fondo de arte contemporáneo del Centre Pompidou de Paris.

Since 2018, Naoshima stool is part of the contemporary art collection of the Centre Pompidou in Paris.

Medidas / Dimensions

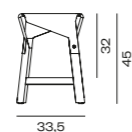
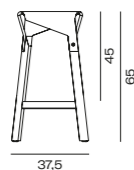
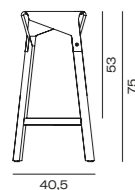

Asiento / Seat

Madera contrachapada de roble o haya./ Oak or beech veneer plywood.



Haya natural / Natural beech



Haya / Beech White 93



Haya / Beech Grey 74



Haya / Beech Grey 79



Roble natural / Natural oak



Roble / Oak 7030 PO



Roble / Oak 1027 PO



Roble / Oak 6013 PO



Roble / Oak 6006 PO



Roble / Oak 5004 PO



Roble / Oak 9004 PO

Patas / Legs

Madera maciza de roble o haya./ Solid oak or beech wood



Haya natural / Natural beech



Haya / Beech White 93



Haya / Beech Grey 74



Haya / Beech Grey 79



Roble natural / Natural oak



Roble / Oak 7030 PO



Roble / Oak 1027 PO



Roble / Oak 6013 PO



Roble / Oak 6006 PO



Roble / Oak 5004 PO



Roble / Oak 9004 PO

Todos los acabados que se muestran a continuación forman parte de una elaborada selección. Para ver carta completa de acabados dirigirse a pág. 112./ All finishes shown below are part of an elaborate color palette. To see the complete catalogue of finishes see page 112.

Certificados / Certificates

Modelo / Model 701. 1st Level EN 16139:2013.

Acabados madera / Wooden finishes

Madera de fresno y roble lacada / Lacquered ash & oak wood

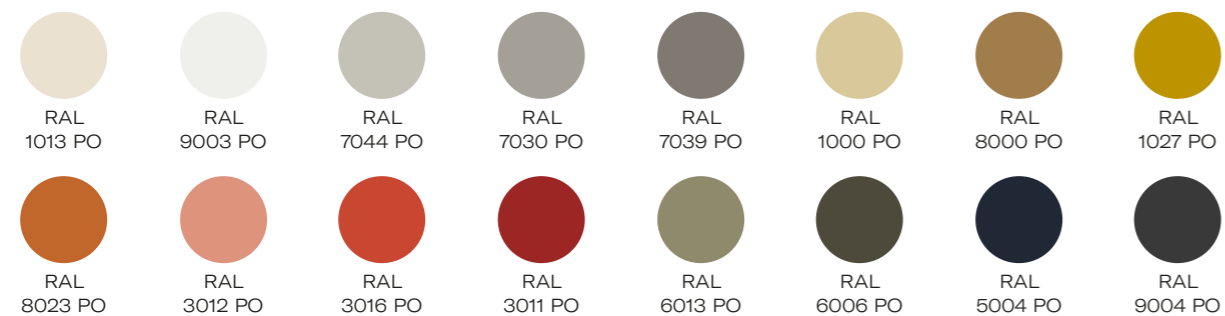

Madera de haya tintada / Dye beech wood

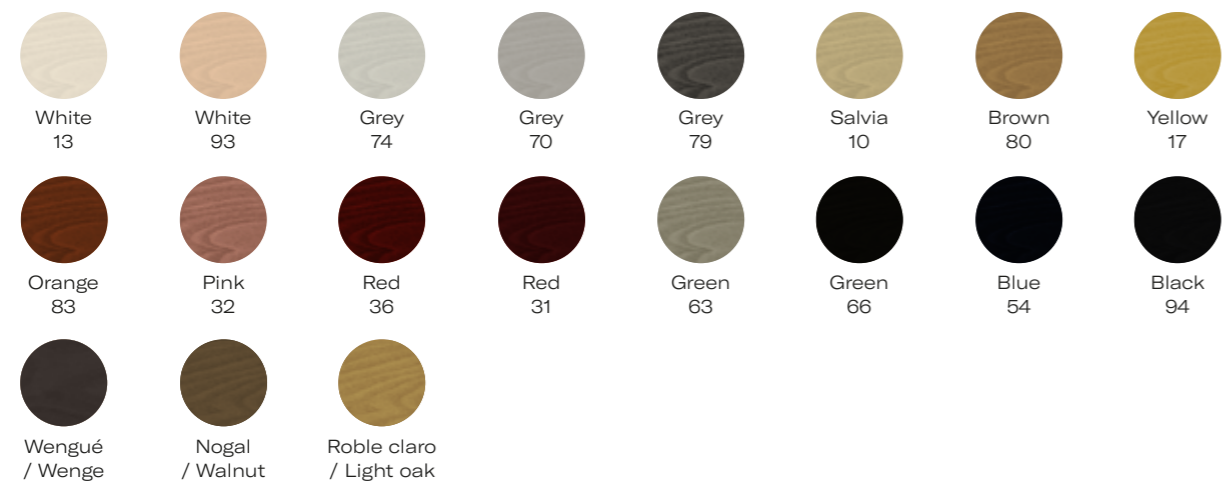

Madera natural barnizada / Natural wood varnished

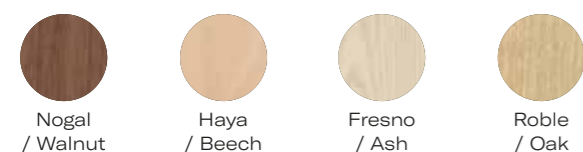

Acabados metal / Metal finishes

Acero lacado / Lacquered steel

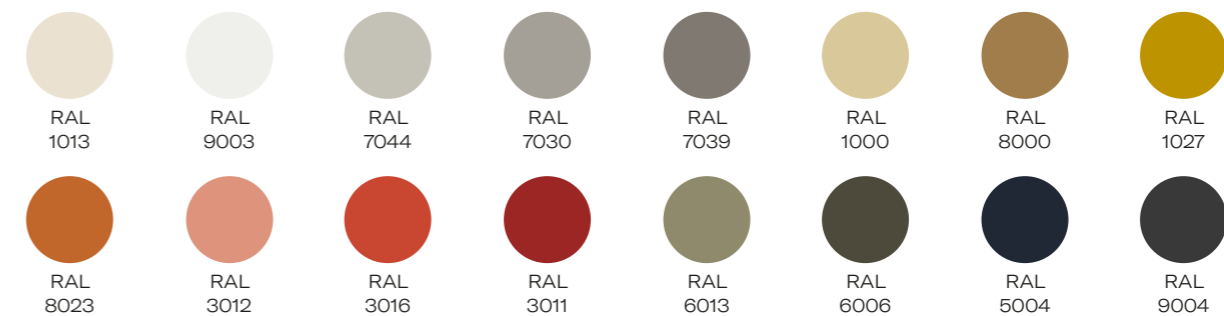

Acabados metálicos / Metal finishes



Los colores y acabados referenciados en este catálogo pueden variar respecto a la realidad, para una equivalencia mas precisa consultar el muestrario general de materiales y acabados. Todos los colores de pinturas y lacas corresponden a la carta RAL. Todos nuestros productos se pueden personalizar a la medida de cada proyecto, de hostelería y colectividades, según los requerimientos de cada cliente y preescriptor. Todas las medidas están expresadas en cm, con una tolerancia de +/- 0.5.

The colours and finishes referenced in this catalogue may vary. For more precise compatibility, check our general collection of material and finish samples. All paint and lacquers are from the RAL portfolio. All our products may be customized to any hotel & restaurant project or community according to the requirements of each client and the relevant specifications. All measurements are expressed in cm with a +/- 0.5 margin.

Acabados tapizado / Upholstery finishes

Gabriel

Textil / Fabric – Note, Harmony, Mood, Fame, Go Uni, Atlantic & Go Check.



Crevin

Textil / Fabric – Dolce In/Out.



Spradling

Piel Vegana (PV) / Vegan leather – Dolce.



Penelopeggi

Piel Natural / Natural leather – Nuvola.



Rattan / Cane

Este acabado es de uso exclusivo para el respaldo de la colección Bernardes./ This finish is exclusively for the backrest of the Bernardes collection.



Acabados de sobres de mesas / Table top finishes

Madera de fresno y roble lacada / Lacquered ash & oak wood



Madera de haya tintada / Dye beech wood

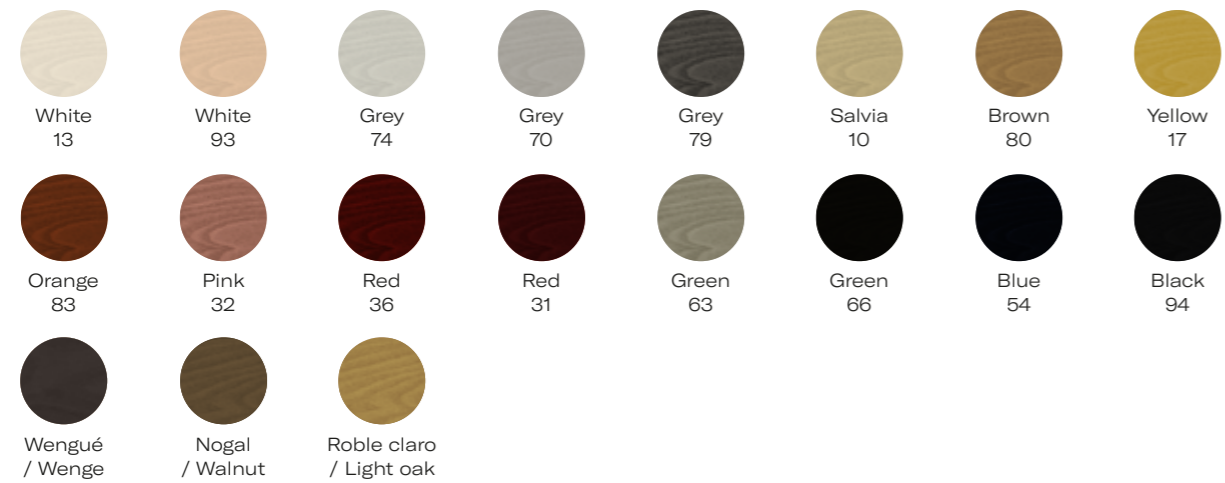

Madera natural barnizada / Natural wood varnished

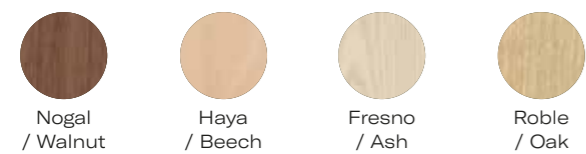

Dekton acabado mineral / Dekton mineral finishes



Silestone acabado mineral / Silestone mineral finishes



Acabados Formica / Formica finishes

Laminado HPL./ HPL laminate.

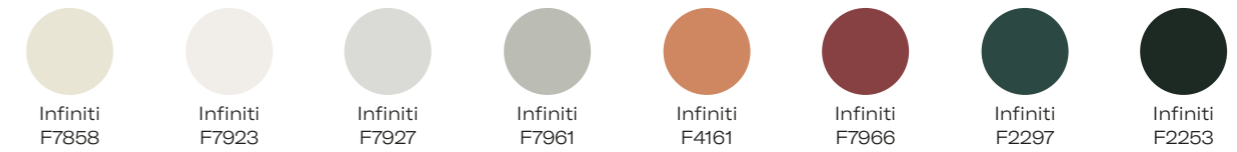

Acabados estructuras de mesas / Table frame finishes

Acero lacado / Lacquered steel

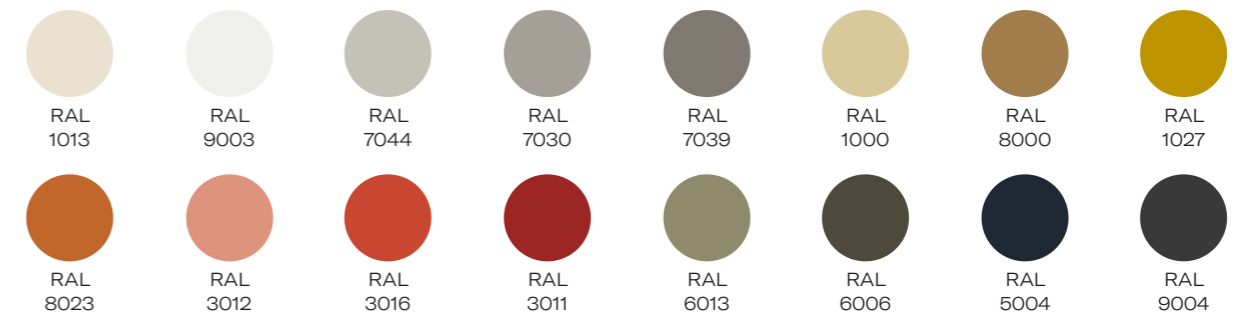

Acabados metálicos / Metal finishes



Ctra. Brunells, s/n
17853 Tortellà, Girona
T. +34 972 287 277
F. +34 972 687 635
info@verges.design
www.verges.design

Creative & Art Direction
Emiliana Design Studio

Set Design
Emiliana Design Studio

Graphic Design
P.A.R

Product photography
Francesc Rabat

Landscape photography
Esteve Serra

Prelude text
Slowkind

Thanks to:
nanimarquina, Vibia, Murmull, Ekobo.

