

# news

 VILAGRASA

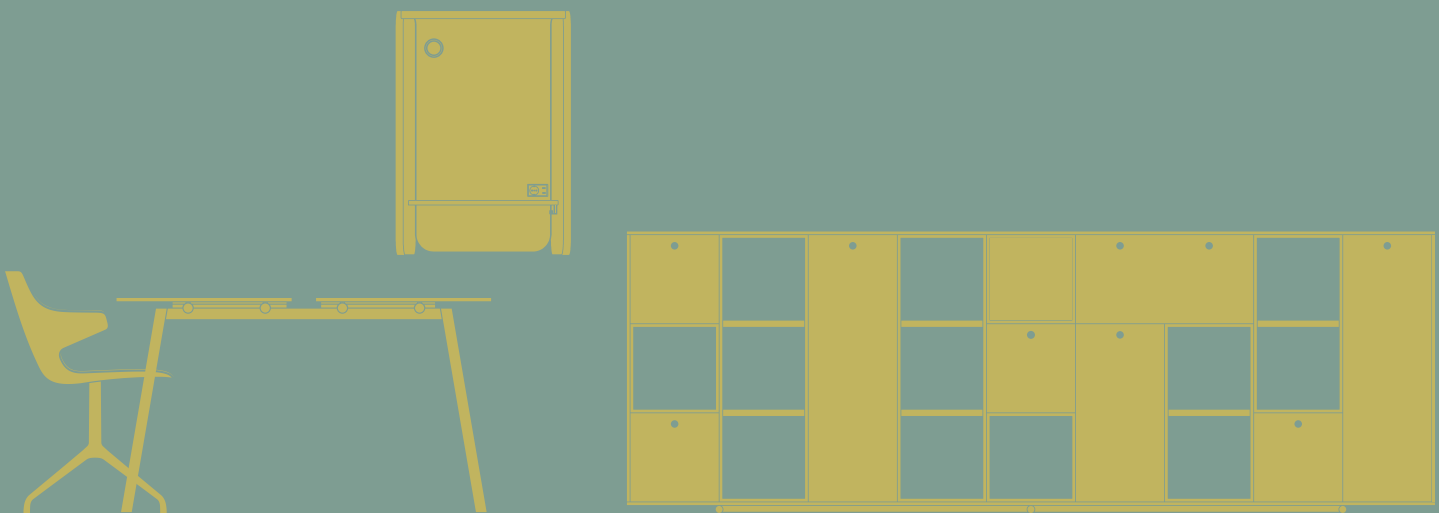

 **VILAGRASA**



Un aire fresco a nuestra esencia.  
Queremos trabajar contigo  
y queremos hacerlo para ti.

---

A new fresh air to our essence.  
We want to work with you  
and we want to do it for you.



angie

-P 6

rolling

-P 14

stone

-P 24

noren

-P 36

booth

-P 44

wait

-P 50

check

-P 62



# angie

## day-to-day partner

**designer**

Josep  
Lluscà

**use**

office  
corporate

**product**

chair  
bench seating



# angie collection

Silla de formas suaves y ligeras, el asiento fluye, dibujando una silueta con alto valor estético y grandes cualidades ergonómicas.

Chair with soft and light shapes, the seat flows, drawing a silhouette with high aesthetic value and great ergonomic qualities.









# angie collection

## info

Silla para uso interior y exterior (según modelos). Carcasa inyectada en fibra de vidrio y PP. Estructura de acero, aluminio y plástico. Apilable (según modelos).

Chair for indoor and outdoor use (depending on models). Injected housing in fiberglass and PP. Structure made of steel, aluminum and plastic. Stackable (depending on models).

### ESTRUCTURAS | STRUCTURES



Silla cuatro patas  
Four legs chair

W 58.5 cm / 23.03 in  
L 56.8 cm / 22.36 in  
H 78.5 cm / 30.9 in

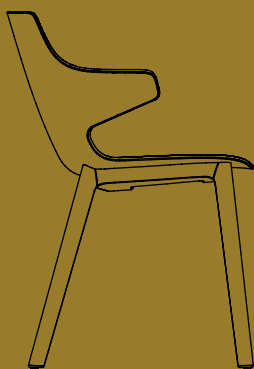

Silla cuatro patas click  
Click four legs chair

W 58.5 cm / 23.03 in  
L 54.0 cm / 21.25 in  
H 78.5 cm / 30.9 in

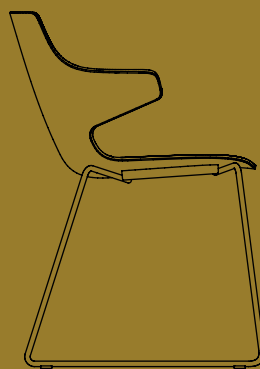

Silla patín  
Sled-base chair

W 58.5 cm / 23.03 in  
L 56.0 cm / 22.04 in  
H 78.5 cm / 30.9 in



Silla patas araña  
Spider legs chair

W 58.5 cm / 23.03 in  
L 54.0 cm / 21.25 in  
H 78.5 cm / 30.9 in

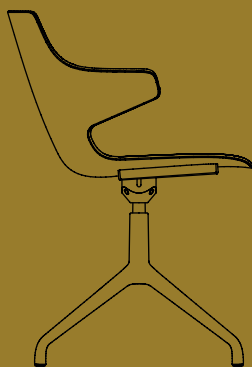

Silla patas araña aluminio  
Aluminium spider legs chair

W 58.5 cm / 23.03 in  
L 54.0 cm / 21.25 in  
H 78.5 cm / 30.9 in

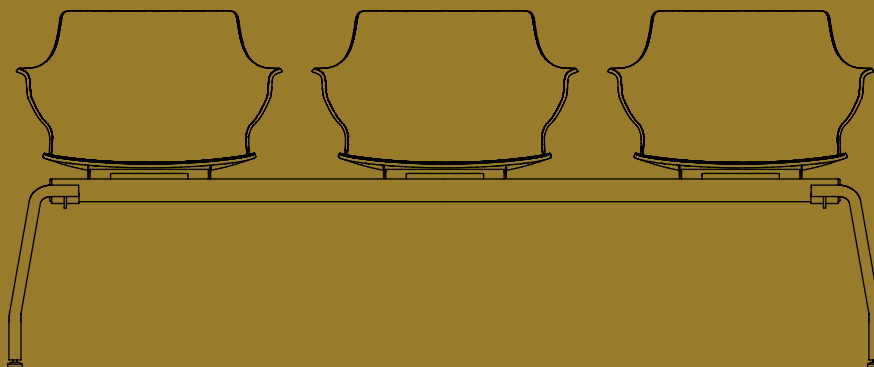

Bancada  
Bench seating

W 191.7cm / 75.47 in  
L 54.0 cm / 21.25 in  
H 78.5 cm / 30.9 in

---

POLIPROPILENO | POLYPROPYLENE



Chocolate  
Chocolate

Arena  
Sand

Blanco  
White

Gris cachemira  
Cashmere grey

Verde oliva  
Olive green

---

LACADOS | LACQUERED



Chocolate  
Chocolate

Arena  
Sand

Blanco  
White

Gris cachemira  
Cashmere grey

Verde oliva  
Olive green

---

TAPICERIAS | UPHOLSTERY

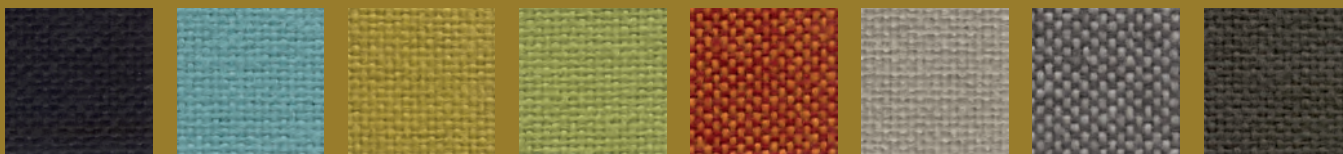

JET 8033  
FIDIVI

JET 6007  
FIDIVI

JET 3019  
FIDIVI

JET 7041  
FIDIVI

JET 9404  
FIDIVI

JET 1006  
FIDIVI

JET 9109  
FIDIVI

JET 2012  
FIDIVI

Otras opciones de tapizado consultar  
Other upholstery under request

---

CARCASAS | SHELLS

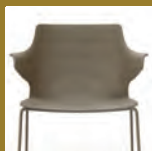

Polipropileno  
Polypropylene



Polipropileno con cojín en asiento  
Polypropylene with seat cushion

---

ACCESORIOS | ACCESSORIES

Conector  
Linking device



# rolling

# all under control

**designer**

Josep  
Llusçà

**use**

office  
corporate  
collectivities  
libraries

**product**

storage



# rolling storage

**Sistema modular de almacenamiento para oficinas, bibliotecas, corporaciones.**  
Modular storage system for offices, libraries, corporations.









# rolling storage info

Sistema de almacenamiento personalizable. Distintas opciones. Acabados en madera y melamina

Customizable storage system. Different options. Finishes in Wood and melamine

## MUEBLES | FURNITURES

W 45.0 cm / 17.7 in  
H 86.7 cm / 34.1 in

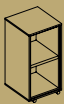

L 43.2 cm  
17.0 in

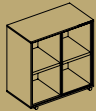

L 83.2 cm  
32.7 in

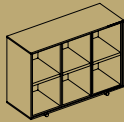

L 123.2 cm  
48.5 in

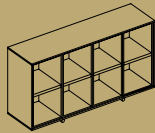

L 163.2 cm  
64.2 in

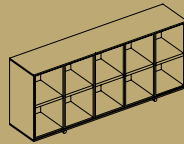

L 203.2 cm  
80.0 in

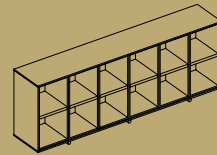

L 243.2 cm  
95.7 in

W 45.0 cm / 17.7 in  
H 126.7 cm / 49.8 in

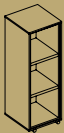

L 43.2 cm  
17.0 in

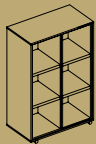

L 83.2 cm  
32.7 in

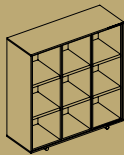

L 123.2 cm  
48.5 in

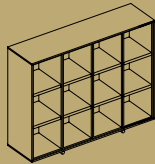

L 163.2 cm  
64.2 in

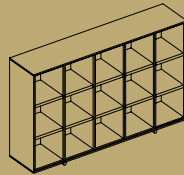

L 203.2 cm  
80.0 in

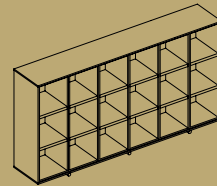

L 243.2 cm  
95.7 in

W 45.0 cm / 17.7 in  
H 166.7 cm / 65.6 in



L 43.2 cm  
17.0 in

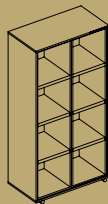

L 83.2 cm  
32.7 in

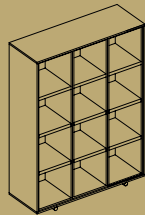

L 123.2 cm  
48.5 in

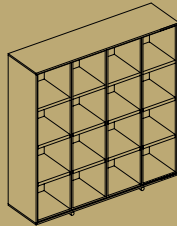

L 163.2 cm  
64.2 in

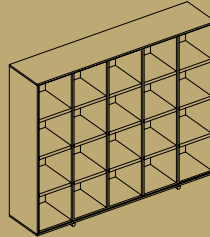

L 203.2 cm  
80.0 in

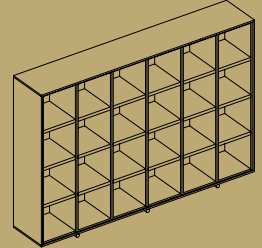

L 243.2 cm  
95.7 in

---

PUERTAS | DOORS

40X40 cm  
15.7x15.7 in



80X40 cm  
31.5x15.7 in

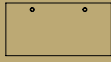

40X80 cm  
15.7x31.5 in



40X120 cm  
15.7x47.2 in



60x120 cm  
23.6x47.2 in



40X160 cm  
15.7x62.9 in



60X160 cm  
23.6x62.9 in



---

LÁMINA TRASERA | BACK SHEET

40X40 cm  
15.7x15.7 in



80X40 cm  
31.5x15.7 in



40X80 cm  
15.7x31.5 in



40X120 cm  
15.7x47.2 in



80x120 cm  
31.5x47.2 in



120X100 cm  
47.2x47.2 in

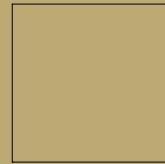

160X120 cm  
62.9x47.2 in



40X160 cm  
15.7x62.9 in



80X160 cm  
31.5x63 in



160X160 cm  
63x63 in

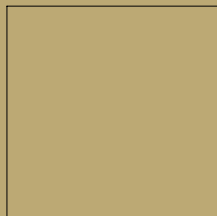

---

MADERA Y LAMINADOS | WOOD AND LAMINATES

Acabado de la estructura y lámina trasera en madera | Structure and back sheet in wood finishes



Roble natural  
Natural oak

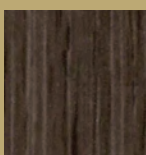

Roble ahumado  
Smoked oak

---

Acabado de la estructura y lámina trasera en melamina | Structure and back sheet finishes in melamine



Blanco  
White

Gris cachemira  
Cashmere grey

Roble  
Oak

Acabado de las puertas | Doors finishes



Naranja  
Orange

Gris marrón  
Brown grey

Verde fiordo  
Fjord green

Blanco  
White

Gris cachemira  
Cashmere grey

Roble  
Oak

Acabado del interior del mueble en melamina | Inside finishes in melamine



Gris cachemira  
Cashmere grey

Gris marrón  
Brown grey

---

LACADOS | LACQUERED

Zócalos | Bases



Antracita  
Anthracite

ACCESORIOS | ACCESSORIES

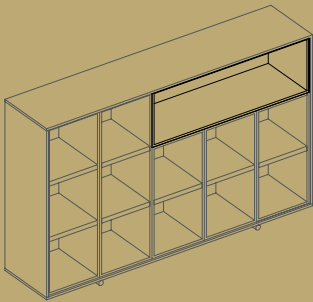

Credenza  
Credenza  
120x40 cm  
47.2x15.7 in

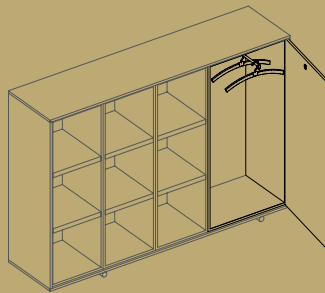

Ropero  
Wardrobe  
60x120 cm  
23.6x47.2 in

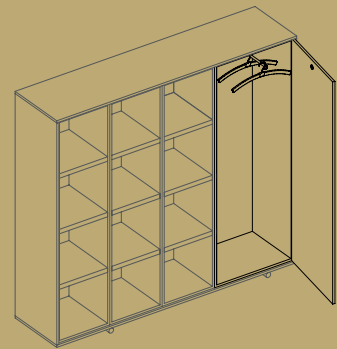

Ropero  
Wardrobe  
60x160 cm  
23.6x63 in

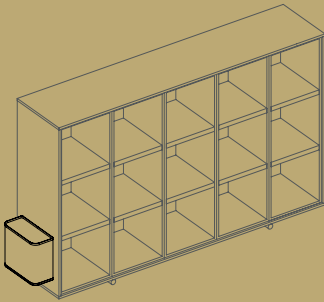

Papelera  
Paper bin

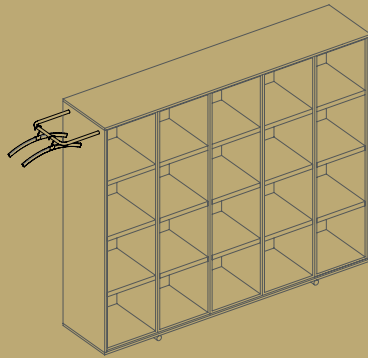

Perchero  
Coat rack





# stone

## working together

**designer**

Josep  
Lluscà

**use**

office  
corporate  
collectivities  
libraries

**product**

table

# stone table

**Sistema de mesas modulares para espacios de trabajo, individuales o colaborativos. Adecuados para oficina, biblioteca, despacho de dirección.**

System of modular tables for work spaces, individual or collaborative. Suitable for office, library, management office.

















# stone table info

Sistema de mesas personalizable. Distintas opciones de mesas y accesorios. Acabados en roble, haya y melamina.

Customizable tables system. Different options of tables and accessories. Finishes in oak, beech and melamine.

## MESAS | TABLES

Mesa Stone oficina  
Stone office table

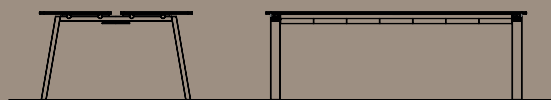

L 164.5 cm | 64.7 in  
W 129 cm | 50.7 in  
H 74 cm | 29.1 in

L 192 cm | 75.5 in  
W 129 cm | 50.7 in  
H 74 cm | 29.1 in

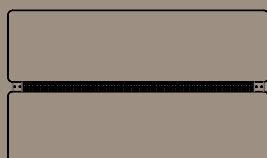

L 222 cm | 87.4 in  
W 129 cm | 50.7 in  
H 74 cm | 29.1 in



L 313 cm | 123.2 in  
W 129 cm | 50.7 in  
H 74 cm | 29.1 in

L 368 cm | 144.8 in  
W 129 cm | 50.7 in  
H 74 cm | 29.1 in

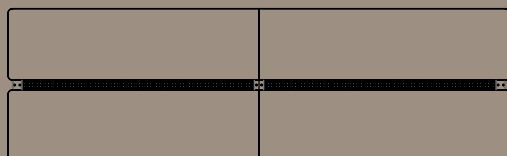

L 424 cm | 166.9 in  
W 129 cm | 50.7 in  
H 74 cm | 29.1 in



L 461.5 cm | 181.3 in  
W 129 cm | 50.7 in  
H 74 cm | 29.1 in

L 544 cm | 213.8 in  
W 129 cm | 50.7 in  
H 74 cm | 29.1 in

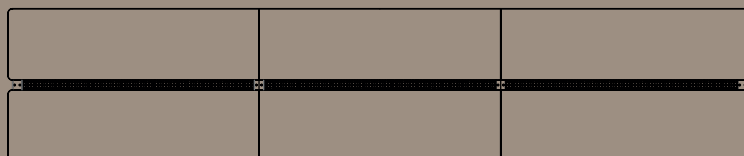

L 628 cm | 247.2 in  
W 129 cm | 50.7 in  
H 74 cm | 29.1 in

Otras medidas consultar  
Other sizes under request

Mesa Stone biblioteca  
Stone library table



L 313 cm | 123.2 in  
W 123 cm | 48.4 in  
H 74 cm | 29.1 in

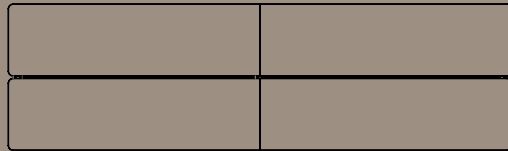

L 368 cm | 144.8 in  
W 123 cm | 48.4 in  
H 74 cm | 29.1 in

L 424 cm | 166.9 in  
W 123 cm | 48.4 in  
H 74 cm | 29.1 in



L 544 cm | 214.1 in  
W 123 cm | 48.4 in  
H 74 cm | 29.1 in



L 544 cm | 214.1 in  
W 123 cm | 48.4 in  
H 74 cm | 29.1 in

L 628 cm | 247.2 in  
W 123 cm | 48.4 in  
H 74 cm | 29.1 in

Mesa Stone individual / dirección  
Individual Stone table / executive desk

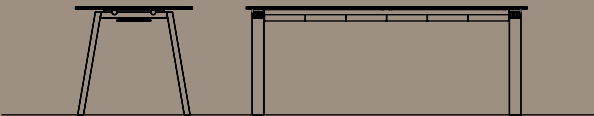

L 192 cm | 75.6 in  
W 80 cm | 31.4 in  
H 74 cm | 29.1 in

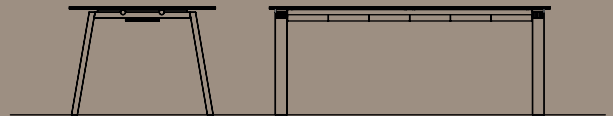

L 192 cm | 75.1 in  
W 100 cm | 39.3 in  
H 74 cm | 29.1 in

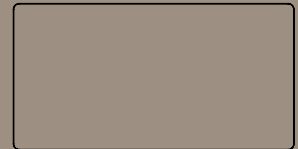

MADERAS Y LAMINADOS | WOODS AND LAMINATES

Acabados de las patas en madera | Wood leg finishes



Roble natural  
Natural oak

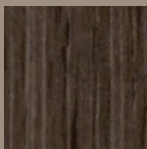

Roble ahumado  
Smoked oak



Haya natural  
Natural beech



Haya ahumada  
Smoked beech

Acabados de las encimeras en madera | Wood work top finishes



Roble natural  
Natural oak

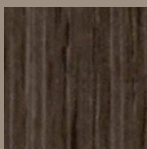

Roble ahumado  
Smoked oak

---

Acabados de las encimeras en melamina | Melamine work top finishes



Blanco  
White



Gris cachemira  
Cashmere grey

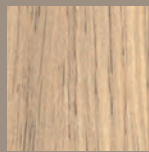

Roble  
Oak

---

LACADOS | LACQUERED

Estructuras | Structures



Antracita  
Anthracite

---

ACCESORIOS | ACCESSORIES



Bandeja de electrificación  
Electrification tray



Base para enchufes, datos, USB y multimedia  
Base for plug, data, USB and multimedia



Panel separador  
Dividing panels



Lámpara sobremesa  
Table lamp





# noren

## sharing knowledge

designer

Carrasco  
Barceló

use

office  
corporate

product

table

# noren table

**Mesa modulable, de líneas limpias y funcionales, que se puede adaptar a diferentes tipos de mobiliario y ambiente**

Modulable table, with clean and functional lines, which can be adapted to different types of furniture and environment











# noren table

## info

Mesa con pie doble para uso interior y exterior compuesto por dos bases inyectadas en fibra de vidrio con PP mediante tecnología de moldeo asistida por gas, enlazadas entre sí por una barra de aluminio cubierto por un perfil de pvc texturizado. Protección UV.

Table with double pedestal base for indoor and outdoor use, composed by two bases injected in fibreglass with PP using gas assisted injection moulding technology, joined by an aluminium bar covered by a textured pvc prole. UV Protection.

ESTRUCTURAS | STRUCTURES

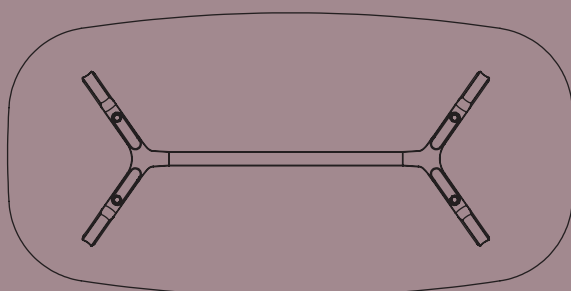

Mesa ovalada  
Oval shaped table

160 cm | L 62.9 in  
W 100 cm | 39.3 in

L 180 cm | 70.8 in  
W 100 cm | 39.3 in

L 200 cm | 78.7 in  
W 110 cm | 43.3 in

L 220 cm | 86.6 in  
W 110 cm | 43.3 in

L 240 cm | 86.6 in  
W 110 cm | 43.3 in

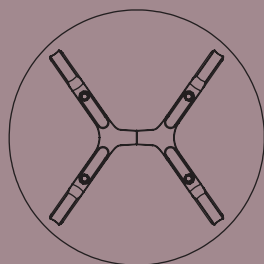

Mesa redonda  
Round table

Ø 100 cm | 39.3 in

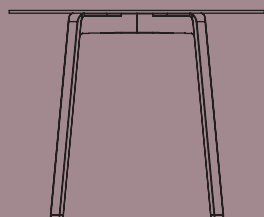

---

## POLIPROPILENO | POLYPROPYLENE

Acabado de las patas en polipropileno | Finishing polypropylene legs



Blanco  
White

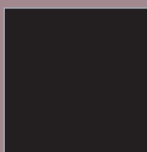

Negro  
Black

## COMPACTO FENÓLICO | HPL

Acabados de las encimeras en compacto fenólico | HPL top finishes



Roble natural  
Natural oak



Madera lavada  
Washed wood



Roble ceniza  
Ashen oak

## CRISTAL TEMPLADO | TEMPERED GLASS

Acabados de las encimeras en cristal templado | Tempered glass top finishes





# booth

a space  
without  
noise

designer

Joan  
Gaspar

use

office  
corporate  
collectivities

product

table



# booth table

**Mesa con pantallas acústicas. Su forma juega con la luz y las sombras formadas por los bordes biselados, permitiendo un espacio personal dentro de los lugares concurridos.**

Table with acoustic screens its shape plays with the light and the shadows formed by the beveled edges allowing a personal space inside the crowded spaces.







# Booth table info

La mesa Booth cuenta con pantallas acústicas y con un tapizado que absorbe el sonido. Las pantallas se tapizan en un tejido de diseño contemporáneo que reducen el sonido que sale al exterior.

The Booth table is presented with acoustic screens and an upholstery that absorbs sound. The screens are upholstered in a contemporary fabric that reduce the sound that goes outside.

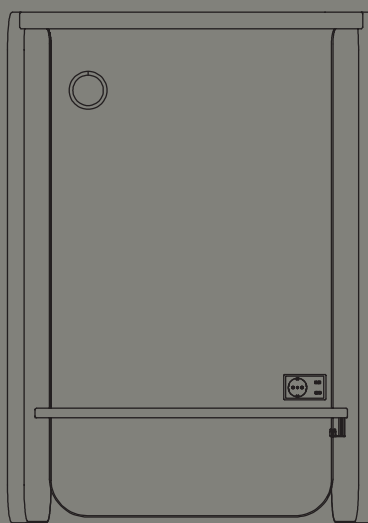
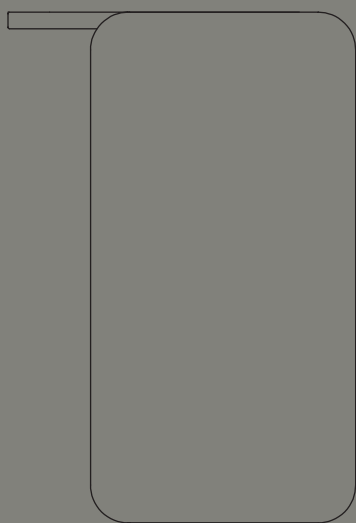

L 78.5 cm / 30.9 in  
W 75.5 cm / 29.7 in  
H 108.5 cm / 42.7 in

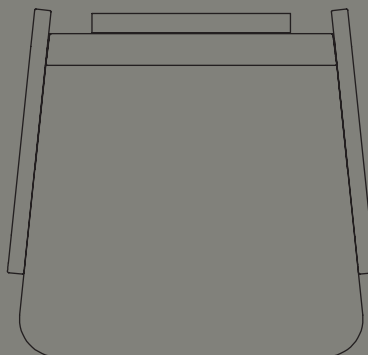
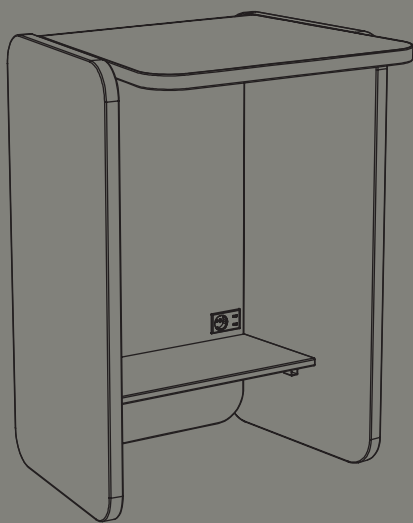

---

## TAPIZADO | UPHOLSTERY



Azul  
Blue



Arena  
Sand



Terracota  
Terracotta

## ACCESORIOS | ACCESSORIES

Luz led | Led light

Conexión eléctrica | Electrical connection

Conexión USB | USB connection



# wait

# comfortable stay

**designer**

Josep  
Llusçà

**use**

home  
work

**product**

chair  
armchair  
bench

# wait bench

Programa de asientos para todos los espacios: colectividades, oficinas, salas de recepción, bibliotecas, ...  
Seating program for all the spaces: collectivity, office, reception rooms, libraries, ...

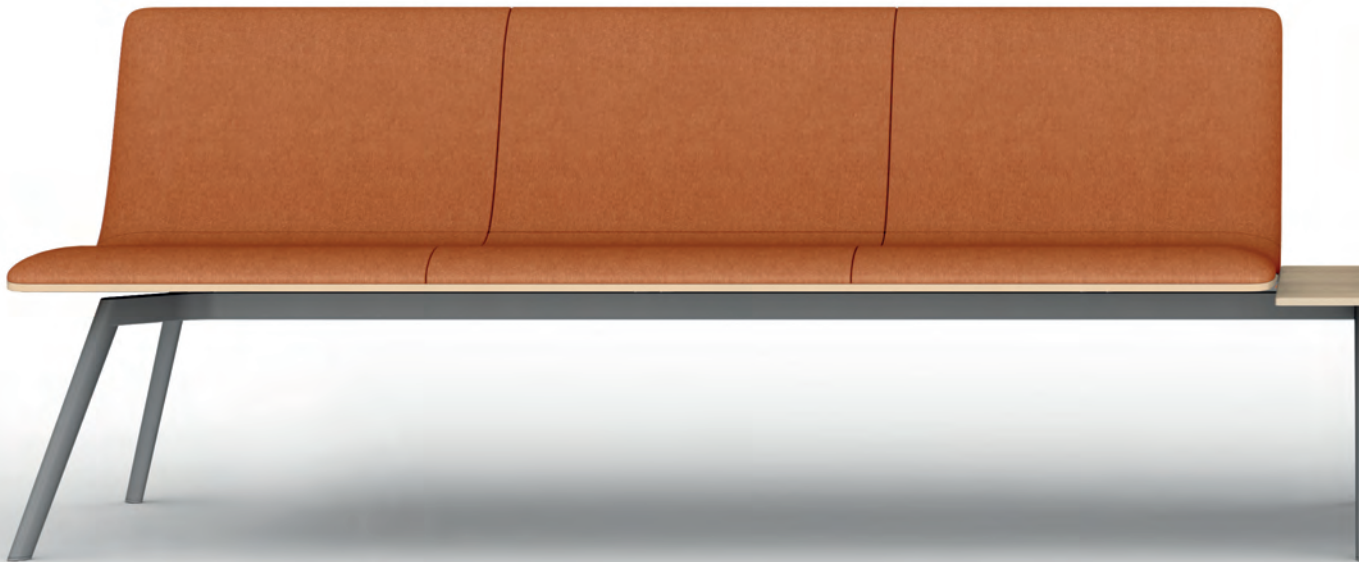













# wait info

Sistema de asientos. Distintas medidas. Acabados en madera curvada, semi-tapizados o completamente tapizado.

Seat system. Different measures. Finishes in curved wood, semi-upholstery or integral upholstery.

## BANCOS | BENCHES

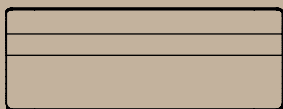
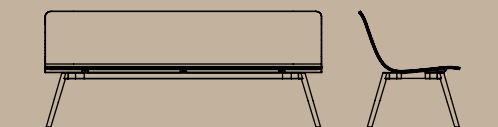

Banco  
Bench

L 120 cm | 47.2 in  
W 66 cm | 25.9 in  
H 76 cm | 29.9 in

L 180 cm | 70.8 in  
W 66 cm | 25.9 in  
H 76 cm | 29.9 in

L 240 cm | 94.4 in  
W 66 cm | 25.9 in  
H 76 cm | 29.9 in

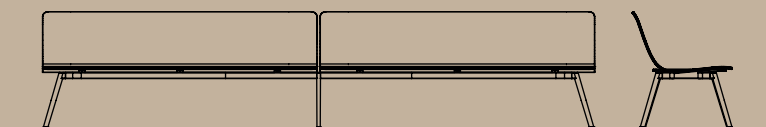

Banco con pata compartida / Otras medidas consultar  
Bench with shared leg / Other measures consult

L 362 cm | 142.5 in  
W 66 cm | 25.9 in  
H 76 cm | 29.9 in

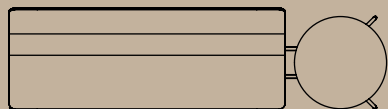
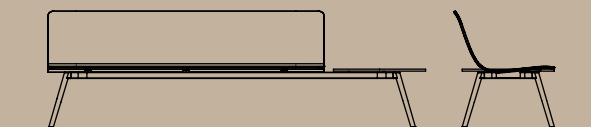

Banco con mesa  
Bench with table

L 186 cm | 73.2 in  
W 66 cm | 25.9 in  
H 76 cm | 29.9 in

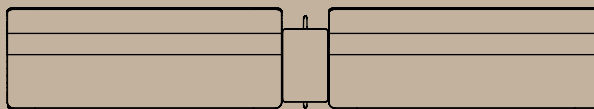
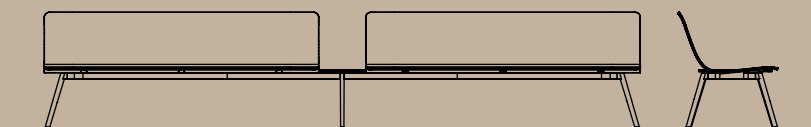

Banco con mesa intermedia y pata compartida / Otras medidas consultar  
Bench with intermediate table and shared leg / Other measures under request

L 391 cm | 153.9 in  
W 66 cm | 25.9 in  
H 76 cm | 29.9 in

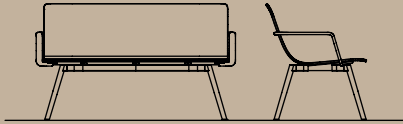

**Banco con brazos en aluminio**  
Bench with aluminium arms

L 120 cm | 47.2 in  
W 66 cm | 25.9 in  
H 76 cm | 29.9 in

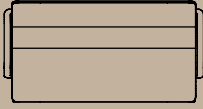

L 180 cm | 70.8 in  
W 66 cm | 25.9 in  
H 76 cm | 29.9 in

L 240 cm | 94.4 in  
W 66 cm | 25.9 in  
H 76 cm | 29.9 in

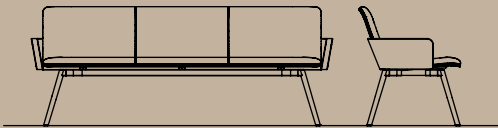

**Banco tapizado con brazos tapizados**  
Upholstered bench with upholstered arms

L 135 cm | 53.1 in  
W 66 cm | 25.9 in  
H 76 cm | 29.9 in

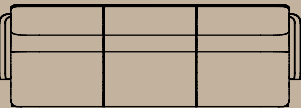

L 195 cm | 76.7 in  
W 66 cm | 25.9 in  
H 76 cm | 29.9 in

L 255 cm | 100.3 in  
W 66 cm | 25.9 in  
H 76 cm | 29.9 in

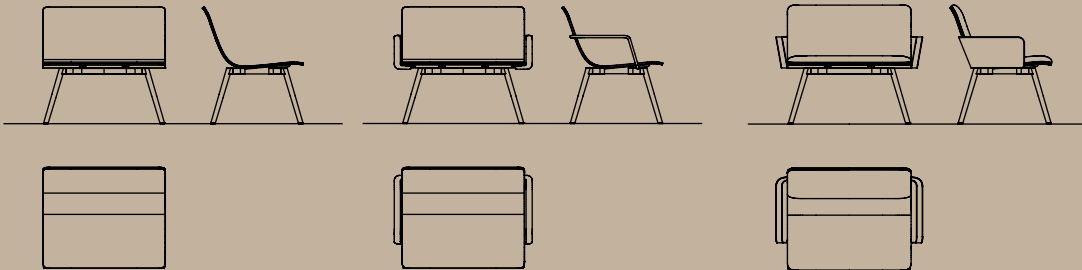

**Butaca**  
Seat

L 80 cm | 31.5 in  
W 66 cm | 25.9 in  
H 76 cm | 29.9 in

**Butaca con brazos en aluminio**  
Seat with aluminium arms

L 90 cm | 35.4 in  
W 66 cm | 25.9 in  
H 76 cm | 29.9 in

**Butaca tapizada con brazos tapizados**  
Upholstered seat with upholstered arms

L 95 cm | 37.4 in  
W 66 cm | 25.9 in  
H 76 cm | 29.9 in

## MADERAS | WOODS

Acabados de las carcasas de los asientos | Finishes of the seat covers



**Roble natural**  
Natural oak

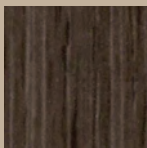

**Roble ahumado**  
Smoked oak



**Haya natural**  
Natural beech



**Haya ahumada**  
Smoked beech

---

## LACADOS | LACQUERED

Acabado de la estructura | Structure finishes



Antracita  
Anthracite



Gris cachemira  
Cashmere grey

---

## TAPICERIA | UPHOLSTERY

Los bancos pueden ser tapizados con todos los acabados de los siguientes fabricantes  
The bench can be upholstered with all the finishes of the following manufacturers



[www.fidivi.com](http://www.fidivi.com)



[www.spradling.eu](http://www.spradling.eu)

Otras opciones de tapizados consultar  
Other upholstery options under request

---

## OPCIONES DE TAPIZADO Y BRAZOS | UPHOLSTERY AND ARMS OPTIONS



Carcasa en madera  
Wood cover



Carcasa en madera y cojines tapizados  
Wood cover and upholstered cushions



Carcasa y cojines tapizados  
Upholstered cover and cushions



Brazos en aluminio  
Arms in aluminum



Brazos tapizados con carcasa y cojines tapizados  
Upholstered armrests with upholstered cover and cushions

 VILAGRASA

# check

## the smart bin of the future

**designer**

Roger  
Vancells

**use**

office  
corporate  
collectivities

**product**

wastepaper



# check wastepaper

Diseñado con líneas sintetizadas y nítidas, muestra una clara vocación de convivencia e integración con la arquitectura de su entorno, sin pretensiones de destacar, convirtiéndose en un elemento más dentro del equipamiento donde se ubique.

Designed with synthesized and clear lines, it shows a clear vocation of coexistence and integration with the architecture of its surroundings, without pretending to stand out, becoming one more element within the equipment where it is located











# check

## DOS SISTEMAS PARA LA OPTIMIZACIÓN DE LA RECOGIDA | TWO SYSTEMS FOR THE OPTIMIZATION OF THE COLLECTION

### DETECTOR ÓPTICO

La papelera Check cuenta con un dispositivo DOP80, medidor de distancias óptico que permite conocer el porcentaje de llenado de la papelera. La información se recoge mediante un microprocesador que envía los datos a una página web informando sobre el momento de la recogida o si todavía hay capacidad suficiente. Con esta información, se podrá realizar una previsión de recogida ya que con los datos se conocerá qué ubicaciones tardarán más en llenarse y cada cuánto tiempo.

### SENSORES DE PESO

En la base de la papelera hay instalados 3 sensores modelo SP06 que recogen el peso total de su contenido. Esta información es muy útil para la gestión del tipo de residuo.

### OPTICAL DETECTOR

Check has a DOP80 device, optical distance meter that allows to know the percentage of filling the bin. The information is collected by a microprocessor that sends the data to a web page notifying the time of collection or if there is still enough capacity. With this information, it will be possible to make a collection forecast thanks to the data that allows to know which locations will take longer to fill and at each time.

### WEIGHT SENSORS

At the base of the bin there are 3 sensors installed Model SP06 that collect the total weight of the content. This information is very useful for waste residue management

## SEGURIDAD TECNOLÓGICA | TECHNOLOGIC SECURITY

### SENSOR DE TEMPERATURA

El sistema cuenta con un termómetro que permite monitorizar la temperatura en la papelera, la alarma se activa cuando supera los límites máximos aceptables lo que sugiere una situación de riesgo o un posible incendio.

### SENSORES DE PESO - MODEL ST9001

Sistema con control de introducción de objetos pesados en el interior de la papelera. El sensor de fuerza recoge el peso y según el incremento instantáneo (configurable) avisa al software central si hay sospecha de que podría ser algún tipo de explosivo.

### TEMPERATURE SENSOR

The system has a thermometer that allows it to monitor the temperature inside the bin, the alarm is activated when it exceeds the maximum acceptable limits which can indicate a situation of risk or a possible fire.

### WEIGHT SENSORS - MODEL ST9001

A system which detects the introduction of heavy objects inside the wastepaper. The weight sensor works when there are instant increments (this is programmable) warns to the central software if there is a suspicion that it could be some kind of explosive.

## ALIMENTACIÓN | ENERGY SOURCE

Mediante pilas de litio. Autonomía de un año.  
Using Lithium Batteries. 1 year of battery life

Dimensión | Dimension  
61,6mm (Al) - 33,4mm (Ø)

Voltaje | Voltage  
3,6V

Capacidad | Capacity  
13Ah

Tecnología | Technology  
Litio de Cloruro de Tionilo  
Lithium thionyl chloride

## RECEPCIÓN DE DATOS | RECEIVING DATA



## VISUALIZACIÓN DE DATOS | DATA VISUALIZATION





# check

Contenedor de residuos de alta capacidad (100L y 180L) destinado a cubrir zonas pública de concurrencia en ámbitos diversos, como grandes instalaciones con espacios interiores y/o exteriores.

High capacity waste container (26,41 gal. / 47,5 gal). Designed to cover public areas, such as large facilities, interior and or exterior spaces.

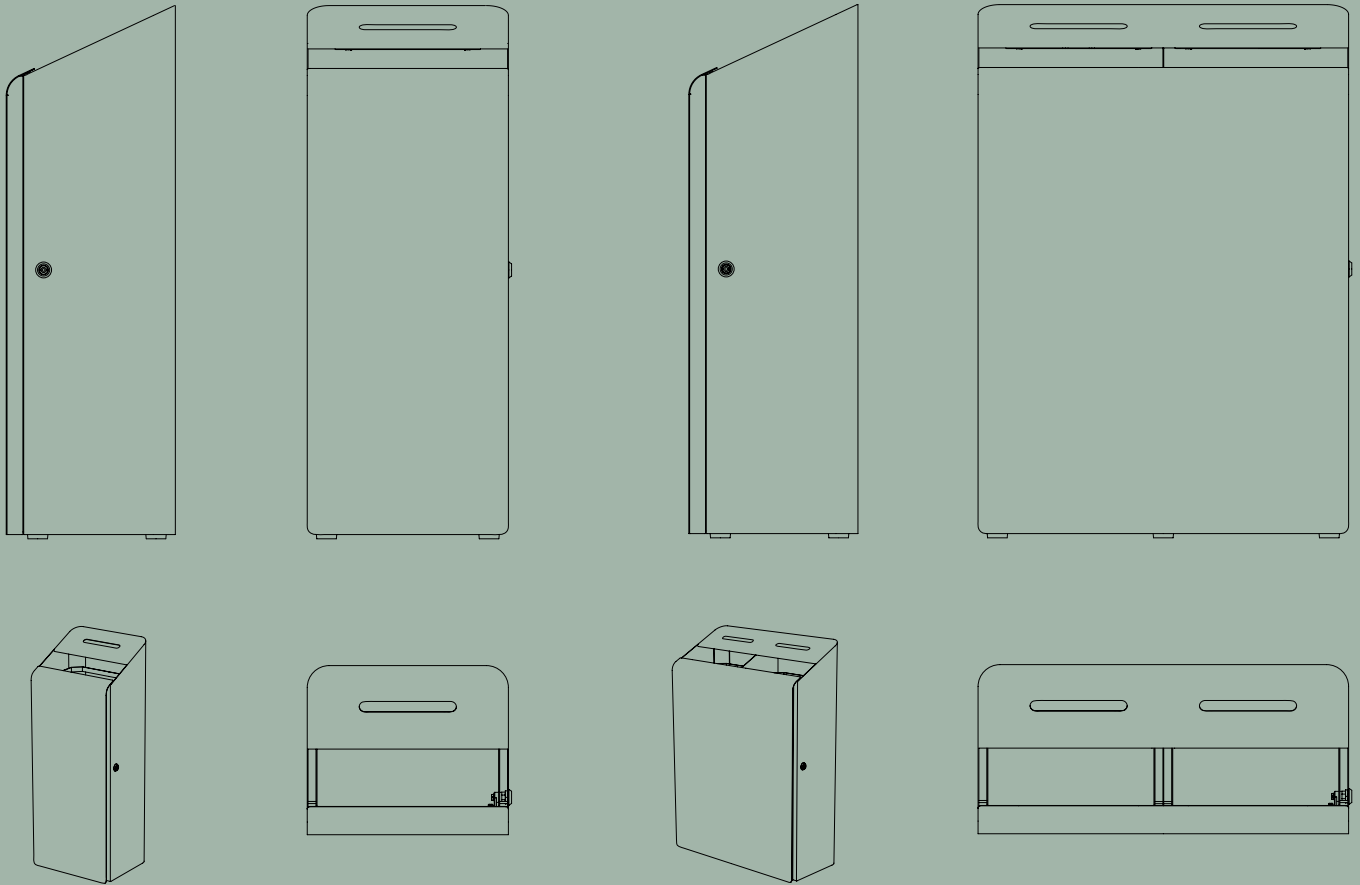

W 33,5 cm | 13.18 in  
L 39 cm | 15.35 in  
H 100.5 cm | 39.56 in

W 33,5 cm | 13.18 in  
L 77 cm | 30.31 in  
H 100.5 cm | 39.56 in

---

ACABADOS | FINISHES

Hierro pintado | Painted iron

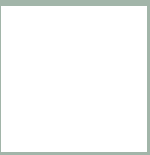

Blanco  
White



Negro  
Black

Vinilos opcionales | Optional Vinyls



Agradecimientos | Acknowledgements

Lluscà Design Barcelona, Carrasco Barceló, Estudi Joan Gaspar, Dummiesgrafic, Fotodisseny J.Ewwwww, Gráficas Gómez Boj, OT Vilagrasa

---

Los colores y las imágenes son representativas y en ningún caso podrán ser motivo de reclamación  
The colours and images are representatives and in any case can not be a reason for a complaint.

# VILAGRASA

Crta. Sta. Coloma Km 46  
17178 Les Preses (Girona)

—

Tel. +34 972 261 100  
Fax. +34 972 269 953

—

e-mail: [vilagrasa@vilagrasa.com](mailto:vilagrasa@vilagrasa.com)  
[www.vilagrasa.com](http://www.vilagrasa.com)

resol  
group

